

*SERVICE MANUAL FOR  
COMPUTERIZED SEWING MACHINE*

***BLN ESANTE***

# GENERAL INFORMATION

This service manual has been compiled for explaining repair procedures of this MODEL.

This was produced based on up-to-date product specifications at the time of issue, but there may have been changes of specifications for the purpose of improvements.

Contact manufacturer or local sales company for information concerning such changes.

Brother Industries, Ltd.  
Nagoya, Japan

## CAUTION

1. Always use rubber gloves when handling printed circuit boards and never touch the metal portion of a printed circuit board with bare hands.
2. Keep your body earthed in order to avoid generating static electricity.
3. Pack printed circuit boards in aluminum foil and avoid subjecting them to any form of impact during storage or transportation.
4. Do not touch or damage the metal portion of a printed circuit board with a screwdriver or any other tool while making repairs or the like.

<b>1. Outline of Mechanism .....</b>	<b>1 - 1</b>
Main Mechanisms .....	1 - 2
Driveline .....	1 - 3
Positions of electronic components .....	1 - 4
Control system block diagram .....	1 - 5
Operation of other electronic components .....	1 - 6
Using the threader .....	1 - 8
<b>2. Disassembly .....</b>	<b>2 - 1</b>
Main parts .....	2 - 2
Accessory table removal .....	2 - 3
Top cover removal .....	2 - 3
Needle plate B assembly removal .....	2 - 3
Needle plate B ASSY disassembly .....	2 - 4
Face plate assembly removal .....	2 - 5
Face plate assembly disassembly .....	2 - 6
Front thread guide cover removal .....	2 - 6
Free arm cover removal .....	2 - 7
Base plate cover removal .....	2 - 7
Bobbin winder removal .....	2 - 7
Front cover removal .....	2 - 8
Front cover disassembly (connector removal) .....	2 - 9
Front cover disassembly (LED lamp R removal) .....	2 - 9
Front cover disassembly (LED lamp 3 removal) .....	2 - 9
Front cover disassembly (VR PCB assembly removal) .....	2 - 9
Front cover disassembly (SS PCB assembly removal) .....	2 - 10
Front cover disassembly (button removal) .....	2 - 10
Front cover disassembly (plate D removal) .....	2 - 10
Front cover disassembly (inverter D6 assembly removal) .....	2 - 11
Front cover disassembly (PCB holder assembly removal) .....	2 - 12
Front cover disassembly (card PCB cover assembly removal) .....	2 - 12
Front cover disassembly (connector cover removal) .....	2 - 12
Front cover disassembly (foot controller jack assembly removal) .....	2 - 13
Front cover disassembly (LCD holder assembly removal) .....	2 - 13
Front cover disassembly (SV keytop removal) .....	2 - 14
Front cover disassembly (LCD assembly removal) .....	2 - 15
Rear cover removal .....	2 - 16
Rear cover disassembly (plate B removal) .....	2 - 16
Rear cover disassembly (plate A removal) .....	2 - 17
Drop cover removal .....	2 - 17
Handle assembly removal .....	2 - 17
Handle ASSY disassembly .....	2 - 17
Power unit, motor unit .....	2 - 18
Power PCB assembly removal .....	2 - 19
Power switch assembly (D6) .....	2 - 19
Base plate assembly removal .....	2 - 20
Inlet assembly removal .....	2 - 20
Knee lifter assembly removal .....	2 - 20
Embroidery unit connector assembly removal .....	2 - 21

Main PCB assembly removal .....	2 - 21
NP PCB assembly (D6) removal .....	2 - 21
NP PCB assembly (D6) disassembly .....	2 - 22
Main motor assembly removal .....	2 - 22
Main motor assembly disassembly .....	2 - 23
<b>Thread tension unit .....</b>	<b>2 - 24</b>
Thread guide assembly removal .....	2 - 25
Thread guide removal .....	2 - 25
Upper thread PCB assembly removal .....	2 - 25
Upper thread PCB ASSY disassembly .....	2 - 25
AT INIT PCB assembly removal .....	2 - 26
AT INIT PCB ASSY disassembly .....	2 - 26
Thread guide cover assembly removal .....	2 - 26
Thread guide cover ASSY disassembly .....	2 - 27
Thread guide cover removal .....	2 - 27
Thread guide shutter link A assembly removal .....	2 - 27
Thread guide shutter link A ASSY disassembly .....	2 - 28
Plate assembly removal .....	2 - 28
Thread guide shutter removal .....	2 - 28
AT pulse motor assembly removal .....	2 - 28
Tension release holder assembly removal .....	2 - 29
Tension presser plate removal .....	2 - 29
Tension plate removal .....	2 - 30
Thread release link removal .....	2 - 30
Thread tension gear assembly removal .....	2 - 31
Thread take up spring assembly removal .....	2 - 32
Thread take up spring ASSY disassembly .....	2 - 32
Thread guide wire removal .....	2 - 32
Spring tape removal .....	2 - 32
<b>Bobbin winder .....</b>	<b>2 - 33</b>
Tension guide assembly removal .....	2 - 34
Bobbin base assembly removal .....	2 - 34
Thread guide plate removal .....	2 - 34
Thread guard plate removal .....	2 - 34
Sub spool stand pin removal .....	2 - 35
Spool pin removal .....	2 - 36
Bobbin winder assembly .....	2 - 36
Bobbin presser cover removal .....	2 - 37
BWSW assembly (D6) removal .....	2 - 37
Spring removal .....	2 - 38
Bobbin presser guide assembly removal .....	2 - 38
Bobbin presser removal .....	2 - 38
BW motor assembly removal .....	2 - 38
<b>Rotary hook driving unit, feed/rotary hook unit, thread cutter unit, side feed unit .....</b>	<b>2 - 39</b>
Lead wire guide holder removal .....	2 - 40
Side feed module removal .....	2 - 40
Thread cutter module removal .....	2 - 40
Feed/rotary hook module removal .....	2 - 41
Sheet removal .....	2 - 41
Lower shaft A assembly removal .....	2 - 41
<b>Needle-presser unit, needle threader unit, upper shaft unit .....</b>	<b>2 - 42</b>
Upper shaft cover removal .....	2 - 43



Tension pulley assembly removal .....	2 - 43
Upper shaft assembly removal .....	2 - 44
Needle-presser module removal .....	2 - 45
Plate spring removal .....	2 - 45
<b>Needle-presser module .....</b>	<b>2 - 46</b>
Presser feed holder assembly removal .....	2 - 47
Threader hook ASSY disassembly .....	2 - 47
Presser pulse motor holder assembly removal .....	2 - 47
Presser pulse motor holder ASSY disassembly .....	2 - 47
Presser dial removal .....	2 - 48
BHSW D6 switch assembly and LED PCB D6 assembly removal .....	2 - 48
PT holder assembly removal .....	2 - 48
PT holder ASSY disassembly .....	2 - 49
Lock nut removal .....	2 - 49
Zigzag adjusting nut removal .....	2 - 49
Spring removal .....	2 - 49
Spring-Z removal .....	2 - 50
Needle holder shaft block removal .....	2 - 50
Spring removal .....	2 - 50
Spring removal .....	2 - 50
Needle holder assembly removal .....	2 - 51
Hook release plate removal .....	2 - 52
Release adjuster removal .....	2 - 52
Release guide plate removal .....	2 - 52
Release lever spring removal .....	2 - 52
Release lever assembly removal .....	2 - 53
Release lever ASSY disassembly .....	2 - 53
Needle holder ASSY disassembly .....	2 - 53
Needle bar ASSY disassembly .....	2 - 53
Thread lever switch unit removal .....	2 - 54
Lever AB unit removal .....	2 - 54
Lever AB unit disassembly .....	2 - 54
Lever AB ASSY disassembly .....	2 - 55
Shaft bushing A removal .....	2 - 55
Adjust plate removal .....	2 - 55
Adjusting plate assembly removal .....	2 - 56
Adjusting plate ASSY disassembly .....	2 - 56
Release plate assembly removal .....	2 - 57
Press foot lifter removal .....	2 - 58
Tension release rod removal .....	2 - 58
Thread take-up lever assembly removal .....	2 - 59
Thread take-up counter weight removal .....	2 - 59
Z zigzag lever assembly removal .....	2 - 60
Thread release lever assembly removal .....	2 - 60
Z zigzag cam removal .....	2 - 61
Z pulse motor assembly removal .....	2 - 61
Shaft removal .....	2 - 61
T cam removal .....	2 - 61
Presser bar removal .....	2 - 62
Thread take-up lever link removal .....	2 - 63
Shaft bushing assembly removal .....	2 - 63
Presser dial gear removal .....	2 - 63
<b>Feed/rotary hook module .....</b>	<b>2 - 64</b>
Drop knob removal .....	2 - 65
Drop lever removal .....	2 - 65

Needle plate A removal .....	2 - 65
Needle plate A disassembly .....	2 - 66
Inner rotary hook bracket assembly removal .....	2 - 66
Cord holder removal .....	2 - 66
Needle plate switch ASSY removal .....	2 - 66
Photo diode holder assembly removal .....	2 - 67
Photo diode holder ASSY disassembly .....	2 - 67
Feed dog removal .....	2 - 67
Outer rotary hook removal .....	2 - 68
Spring removal .....	2 - 69
Feed bar assembly removal .....	2 - 69
Feed dog base assembly removal .....	2 - 69
Feed dog correction plate removal .....	2 - 70
Vertical adjusting screw removal .....	2 - 70
Vertical rod removal .....	2 - 70
Vertical feed bush removal .....	2 - 71
Spring removal .....	2 - 71
F gear stopper plate removal .....	2 - 71
F pulse motor holder assembly removal .....	2 - 72
F pulse motor holder ASSY disassembly .....	2 - 72
Spring removal .....	2 - 72
Shaft stopper plate removal .....	2 - 73
Set screw collar removal .....	2 - 73
Feed arm assembly removal .....	2 - 73
Feed arm ASSY disassembly .....	2 - 74
Lower shaft B assembly removal .....	2 - 74
Lower shaft B ASSY disassembly .....	2 - 75
Stopper plate block removal .....	2 - 75
Drop assembly removal .....	2 - 76
Drop ASSY disassembly .....	2 - 76
Feed adjuster assembly removal .....	2 - 77
Feed adjuster ASSY disassembly .....	2 - 77
Bushing presser B removal .....	2 - 77
<b>Side feed module .....</b>	<b>2 - 78</b>
Side feed arm assembly removal .....	2 - 79
Side feed adjust plate removal .....	2 - 79
Side feed gear removal .....	2 - 80
S pulse motor removal .....	2 - 80
<b>Thread cutter module .....</b>	<b>2 - 81</b>
Thread cutter frame assembly removal .....	2 - 82
Presser plate assembly removal .....	2 - 82
Thread hook ASSY disassembly .....	2 - 83
Rubber removal .....	2 - 83
Thread cutter lever assembly removal .....	2 - 84
Thread cutter lever ASSY disassembly .....	2 - 84
Photo transistor assembly removal .....	2 - 84
Idle gears A and B removal .....	2 - 85
Z pulse motor assembly removal .....	2 - 85
<b>Main parts .....</b>	<b>2 - 86</b>
YPM cover removal .....	2 - 87
X carriage cover removal .....	2 - 88
E hoop stay cover removal .....	2 - 88
ES main cover assembly removal .....	2 - 89
EMB relay PCB assembly lead wire removal .....	2 - 89

EMB unit lead wire assembly removal .....	2 - 89
ES base cover assembly removal .....	2 - 90
Lock release lever assembly removal .....	2 - 90
Lock release lever ASSY disassembly .....	2 - 90
Drop trigger removal .....	2 - 90
EMB relay PCB assembly removal .....	2 - 91
E cord supporter cord removal .....	2 - 91
E cord supporter removal .....	2 - 91
X sensor PCB assembly cord removal .....	2 - 92
X sensor PCB assembly removal .....	2 - 92
X belt presser removal .....	2 - 92
XY carriage unit removal .....	2 - 93
X guide plate removal .....	2 - 93
X pulse motor removal .....	2 - 94
X tension pulley assembly removal .....	2 - 94
X driving gear pulley assembly removal .....	2 - 94
X guide shaft presser removal .....	2 - 95
X slider removal .....	2 - 95
Cord grip removal .....	2 - 95
YPM lead wire assembly removal .....	2 - 96
Cord clip removal .....	2 - 96
Y carriage assembly removal .....	2 - 96
FFC support assembly removal .....	2 - 97
FFC support ASSY disassembly .....	2 - 97
E hoop presser plate assembly removal .....	2 - 97
E hoop stay plate assembly removal .....	2 - 97
E hoop stay plate ASSY disassembly .....	2 - 98
E hoop stay plate ASSY disassembly .....	2 - 98
XC sub cover removal .....	2 - 98
Y pulse motor removal .....	2 - 98
Y tension pulley assembly removal .....	2 - 99
Y slider assembly removal .....	2 - 99
Y driving gear pulley assembly removal .....	2 - 99
FFC cord guide removal .....	2 - 99
Y sensor PCB assembly removal .....	2 - 100

### **3. Assembly .....3 - 1**

#### **Needle-presser unit, needle threader unit, upper shaft unit .....3 - 2**

Plate spring attachment .....	3 - 3
Needle-presser module attachment .....	3 - 4
Upper shaft assembly attachment .....	3 - 5
Needle-presser module and upper shaft assembly connection .....	3 - 6
Upper shaft cover attachment .....	3 - 7

#### **Rotary hook driving unit, feed/rotary hook unit, thread cutter unit, side feed unit .....3 - 8**

Lower shaft A assembly attachment .....	3 - 9
Tension pulley assembly attachment .....	3 - 10
Sheet attachment .....	3 - 10
Feed/rotary hook module attachment .....	3 - 11
Thread cutter module attachment .....	3 - 12
Side feed module removal attachment .....	3 - 12
Lead wire guide holder attachment .....	3 - 13

#### **Bobbin winder unit .....3 - 14**

BW motor assembly attachment .....	3 - 15
Bobbin presser attachment .....	3 - 15
Bobbin presser guide assembly attachment .....	3 - 15
Spring attachment .....	3 - 16
BWSW assembly (D6) attachment .....	3 - 16
Bobbin presser cover attachment .....	3 - 17
Bobbin winder assembly attachment .....	3 - 17
Spool pin attachment .....	3 - 18
Sub spool stand pin attachment .....	3 - 19
Thread guard plate attachment .....	3 - 20
Thread guide plate attachment .....	3 - 20
Bobbin base assembly attachment .....	3 - 21
Tension guide assembly attachment .....	3 - 21
<b>Thread tension unit .....</b>	<b>3 - 22</b>
Spring tape attachment .....	3 - 23
Thread guide wire attachment .....	3 - 23
Thread take up spring ASSY assembly .....	3 - 24
Thread take up spring assembly attachment .....	3 - 24
Thread tension gear assembly attachment .....	3 - 25
Thread release link attachment .....	3 - 26
Tension plate attachment .....	3 - 26
Tension presser plate assembly attachment .....	3 - 27
Tension release holder assembly attachment .....	3 - 28
Thread guide shutter attachment .....	3 - 28
AT pulse motor assembly attachment .....	3 - 29
Thread guide shutter link A ASSY assembly .....	3 - 29
Thread guide shutter link A assembly attachment .....	3 - 29
Plate assembly attachment .....	3 - 30
AT INIT PCB ASSY assembly .....	3 - 30
AT INIT PCB assembly attachment .....	3 - 31
Upper thread PCB ASSY assembly .....	3 - 31
Upper thread PCB assembly attachment .....	3 - 32
Thread guide attachment .....	3 - 32
Thread guide assembly attachment .....	3 - 32
Thread guide cover attachment .....	3 - 33
Thread guide cover ASSY assembly .....	3 - 33
Thread guide cover assembly attachment .....	3 - 33
<b>Power unit, motor unit .....</b>	<b>3 - 34</b>
Main motor assembly attachment .....	3 - 35
Motor fan attachment .....	3 - 35
NP PCB ASSY (D6) assembly .....	3 - 35
NP PCB assembly attachment .....	3 - 36
Main PCB assembly attachment .....	3 - 36
Embroidery unit connector assembly attachment .....	3 - 37
Knee lifter assembly attachment .....	3 - 37
Inlet assembly attachment .....	3 - 37
Base plate assembly attachment .....	3 - 38
Ferrite core attachment .....	3 - 38
Power switch assembly (D6) attachment .....	3 - 38
Power PCB assembly (D6US) attachment .....	3 - 39
<b>Main parts .....</b>	<b>3 - 40</b>
Handle assembly .....	3 - 41
Handle assembly attachment .....	3 - 41
Drop cover attachment .....	3 - 41

Rear cover assembly (Plate A attachment) .....	3 - 41
Rear cover assembly (plate B attachment) .....	3 - 42
Rear cover attachment .....	3 - 42
Front cover assembly (LCD assembly attachment) .....	3 - 43
Front cover assembly (SV keytop attachment) .....	3 - 43
Front cover assembly (LCD holder assembly attachment) .....	3 - 44
Front cover assembly (foot controller jack assembly attachment) .....	3 - 44
Front cover assembly (connector cover attachment) .....	3 - 44
Front cover assembly (card PCB cover assembly attachment) .....	3 - 45
Front cover assembly (PCB holder assembly attachment) .....	3 - 45
Front cover assembly (inverter D6 assembly attachment) .....	3 - 46
Front cover assembly (plate D attachment) .....	3 - 46
Front cover assembly (button attachment) .....	3 - 47
Front cover assembly (SS PCB assembly attachment) .....	3 - 47
Front cover assembly (VR PCB assembly attachment) .....	3 - 48
Front cover assembly (LED lamp 3 attachment) .....	3 - 48
Front cover assembly (LED lamp R attachment) .....	3 - 48
Front cover assembly (panel PCB connector attachment) .....	3 - 49
Front cover attachment .....	3 - 50
Bobbin winder attachment .....	3 - 51
Base plate cover attachment .....	3 - 51
Free arm cover attachment .....	3 - 51
Front thread guide cover attachment .....	3 - 52
Face plate ASS assembly .....	3 - 52
Face plate assembly attachment .....	3 - 53
Needle plate B ASSY assembly Needle plate B ASSY assembly .....	3 - 54
Needle plate B assembly attachment .....	3 - 54
Top cover attachment .....	3 - 54
Accessory table attachment .....	3 - 55
<b>Thread cutter module .....</b>	<b>3 - 56</b>
Z pulse motor assembly attachment .....	3 - 57
Idle gears A and B attachment .....	3 - 58
Photo transistor ASSY assembly .....	3 - 58
Photo transistor assembly attachment .....	3 - 59
Thread cutter lever ASSY assembly .....	3 - 59
Thread cutter lever assembly attachment .....	3 - 59
Rubber attachment .....	3 - 60
Thread hook ASSY assembly .....	3 - 60
Presser plate assembly attachment .....	3 - 61
Grease application .....	3 - 61
Thread cutter frame assembly attachment .....	3 - 62
<b>Side feed module .....</b>	<b>3 - 63</b>
S pulse motor attachment .....	3 - 64
Side feed gear attachment .....	3 - 64
Side feed adjust plate attachment .....	3 - 65
Side feed arm assembly attachment .....	3 - 65
<b>Feed/rotary hook module .....</b>	<b>3 - 66</b>
Bushing presser B attachment .....	3 - 67
Feed adjuster ASSY assembly .....	3 - 67
Feed adjuster assembly attachment .....	3 - 68
Drop ASSY assembly .....	3 - 69
Drop assembly attachment .....	3 - 70
Stopper plate block attachment .....	3 - 70
Lower shaft B ASSY assembly .....	3 - 71

Lower shaft B assembly attachment .....	3 - 72
Drop assembly adjustment .....	3 - 73
Grease application .....	3 - 73
Feed arm ASSY assembly .....	3 - 74
Feed arm assembly attachment .....	3 - 75
Set screw collar attachment .....	3 - 75
Shaft stopper plate attachment .....	3 - 76
Spring attachment .....	3 - 76
F pulse motor holder ASSY assembly .....	3 - 76
F pulse motor holder assembly attachment .....	3 - 77
F gear adjustment .....	3 - 78
F gear stopper plate attachment .....	3 - 78
Spring attachment .....	3 - 79
Vertical feed bush attachment .....	3 - 79
Vertical rod attachment .....	3 - 79
Vertical adjusting screw attachment .....	3 - 80
Feed dog correction plate attachment .....	3 - 81
Feed dog base assembly attachment .....	3 - 82
Feed bar assembly attachment .....	3 - 83
Spring attachment .....	3 - 84
Outer rotary hook attachment .....	3 - 85
Feed dog attachment .....	3 - 86
Needle plate A assembly .....	3 - 86
Needle plate A attachment .....	3 - 86
Photo diode holder ASSY assembly .....	3 - 87
Photo diode holder assembly attachment .....	3 - 87
Needle plate switch ASSY attachment .....	3 - 87
Cord holder attachment .....	3 - 87
Inner rotary hook bracket assembly .....	3 - 88
Drop lever attachment .....	3 - 89
Drop knob attachment .....	3 - 90
<b>Needle-presser module .....</b>	<b>3 - 91</b>
Presser dial gear attachment .....	3 - 92
Shaft bushing attachment .....	3 - 93
Thread take-up lever link attachment .....	3 - 94
Presser bar attachment .....	3 - 95
T cam attachment .....	3 - 96
Shaft attachment .....	3 - 96
Z pulse motor assembly attachment .....	3 - 97
Z zigzag cam attachment .....	3 - 97
Thread release lever assembly attachment .....	3 - 98
Z zigzag lever assembly attachment .....	3 - 99
Thread take-up counter weight attachment .....	3 - 100
Thread take-up lever assembly attachment .....	3 - 101
Tension release rod attachment .....	3 - 102
Press foot lifter attachment .....	3 - 103
Release plate assembly attachment .....	3 - 104
Adjusting plate ASSY assembly .....	3 - 105
PF switch D6M assembly attachment and adjustment .....	3 - 105
Adjusting plate assembly attachment .....	3 - 106
Adjust plate attachment .....	3 - 106
Shaft bushing A attachment .....	3 - 106
Lever AB unit assembly .....	3 - 107
Lever AB ASSY assembly .....	3 - 107
Lever AB assembly attachment .....	3 - 108
Threader lever SW unit attachment .....	3 - 109

Needle bar assembly .....	3 - 109
Needle holder ASSY assembly .....	3 - 110
Release lever ASSY assembly .....	3 - 111
Release lever assembly attachment .....	3 - 111
Release lever spring attachment .....	3 - 111
Release guide plate attachment .....	3 - 112
Release adjuster attachment .....	3 - 112
Hook release plate attachment .....	3 - 112
Needle holder assembly attachment .....	3 - 113
Spring attachment .....	3 - 114
Spring attachment .....	3 - 114
Needle holder shaft block attachment .....	3 - 115
Spring-Z attachment .....	3 - 115
Spring attachment .....	3 - 116
Zigzag adjusting nut attachment .....	3 - 116
Lock nut attachment .....	3 - 117
PT holder ASSY .....	3 - 118
PT holder assembly attachment .....	3 - 119
BHSW D6 switch assembly and LED PCB D6 assembly attachment .....	3 - 119
Presser dial attachment .....	3 - 120
Presser pulse motor holder ASSY assembly .....	3 - 120
Presser pulse motor holder assembly attachment .....	3 - 121
Threader hook assembly attachment .....	3 - 122
Presser feed holder attachment .....	3 - 122
<b>Main parts .....</b>	<b>3 - 123</b>
Y sensor PCB assembly attachment .....	3 - 124
FFC cord guide attachment .....	3 - 124
Y driving gear pulley assembly attachment .....	3 - 124
Y slider assembly attachment .....	3 - 125
Y tension pulley assembly attachment .....	3 - 125
Y pulse motor attachment .....	3 - 126
XC sub cover attachment .....	3 - 126
E hoop stay plate ASSY assembly .....	3 - 127
E hoop pressure plate ASSY assembly .....	3 - 127
E hoop stay plate assembly attachment .....	3 - 128
E hoop presser plate assembly attachment .....	3 - 128
FFC support ASSY assembly .....	3 - 129
FFC support assembly attachment .....	3 - 130
Y carriage assembly attachment .....	3 - 131
FFC cord arrangement .....	3 - 132
Cord clip attachment .....	3 - 133
YPM lead wire assembly attachment .....	3 - 134
Cord grip attachment .....	3 - 135
X slider attachment .....	3 - 136
X guide shaft presser attachment .....	3 - 136
X driving gear pulley assembly attachment .....	3 - 137
X tension pulley assembly attachment .....	3 - 137
X pulse motor attachment .....	3 - 138
X guide plate attachment .....	3 - 138
XY carriage unit attachment .....	3 - 139
X belt presser attachment .....	3 - 140
X sensor PCB assembly attachment .....	3 - 140
X sensor PCB assembly cord arrangement .....	3 - 141
E cord supporter attachment .....	3 - 141
E cord supporter cord arrangement .....	3 - 142
EMB relay PCB assembly attachment .....	3 - 142

Drop trigger attachment .....	3 - 143
Lock release lever ASSY assembly .....	3 - 143
Lock release lever assembly attachment .....	3 - 144
ES base cover assembly attachment .....	3 - 145
EMB unit lead wire assembly attachment .....	3 - 145
EMB relay PCB assembly attachment .....	3 - 145
ES main cover assembly attachment .....	3 - 146
E hoop stay cover attachment .....	3 - 146
X carriage cover attachment .....	3 - 147
YPM cover attachment .....	3 - 148

#### **4. Adjustment .....4 - 1**

Touch panel adjustment .....	4 - 2
Timing belt tension adjustment .....	4 - 3
Motor belt tension adjustment .....	4 - 4
Upper shaft rotation shutter angle adjustment .....	4 - 5
Three point needle drop adjustment .....	4 - 6
Needle clearance left/right adjustment .....	4 - 7
Needle bar rising adjustment .....	4 - 8
Needle bar height adjustment .....	4 - 9
Needle threader adjustment .....	4 - 10
Clearance between needle and rotary hook point adjustment .....	4 - 11
Presser bar height and parallelism adjustment .....	4 - 12
Needle and presser front/back position adjustment .....	4 - 13
Fine tension adjustment .....	4 - 14
Upper thread tension adjustment .....	4 - 15
Thread guide shutter clearance adjustment .....	4 - 16
Inner rotary hook tension adjustment .....	4 - 17
Inner rotary hook bracket position adjustment .....	4 - 18
Cloth pressure setting adjustment .....	4 - 19
Feed dog height and squareness adjustment .....	4 - 20
Front/back and left/right position of feed dog adjustment .....	4 - 21
Feed forward/backward adjustment .....	4 - 22
Side feed straight stitch adjustment .....	4 - 23
One point adjustment .....	4 - 24
Bobbin winder adjustment .....	4 - 25
Knee lifter position adjustment .....	4 - 26
BH lever switch position adjustment .....	4 - 27
X-belt tension adjustment .....	4 - 28
Y-belt tension adjustment .....	4 - 29



X-carriage height adjustment ..... 4 - 30

**5. Failure Investigation for Electronic Parts ..... 5 - 1**

Error message list ..... 5 - 2

The power does not come on ..... 5 - 3

Pulse motors do not return to starting point ..... 5 - 5

The touch panel does not work ..... 5 - 7

Main motor does not turn ..... 5 - 8

Main motor rotation abnormal ..... 5 - 10

Cannot sew pattern well ..... 5 - 11

Cannot sew button holes well ..... 5 - 12

Stitch length and zigzag width cannot be done by manual adjustment ..... 5 - 13

Problems with vertical needle movement and reverse stitching ..... 5 - 14

Does not operate when the foot controller is used ..... 5 - 15

Needle bar cutting and separating does not occur normally ..... 5 - 16

Thread tensioning does not go well ..... 5 - 17

Thread cutter does not work normally ..... 5 - 19

Bobbin winding cannot be done ..... 5 - 20

The lamp at hand does not have light ..... 5 - 21

Bobbin thread detection does not work normally ..... 5 - 23

Upper thread sensor does not work normally ..... 5 - 24

The presser foot lifter does not work correctly ..... 5 - 25

Card cannot be used normally ..... 5 - 27

The hoop sensor does not function normally ..... 5 - 28

Embroidery unit does not operate normally ..... 5 - 29

Unable to detect frame ..... 5 - 32

Error is displayed ..... 5 - 34

**6. Special Instructions of Wiring ..... 6 - 1**

Needle bar module wiring ..... 6 - 2

Rotary hook module wiring ..... 6 - 6

Thread cutter module wiring ..... 6 - 7

Main PCB wiring ..... 6 - 8

Front cover wiring ..... 6 - 10

Bobbin winder unit wiring ..... 6 - 12



# 1 Outline of Mechanism

---

---

Main Mechanisms .....	1 - 2
Driveline .....	1 - 3
Positions of electronic components.....	1 - 4
Control system block diagram.....	1 - 5
Operation of other electronic components .....	1 - 6
Using the threader.....	1 - 8

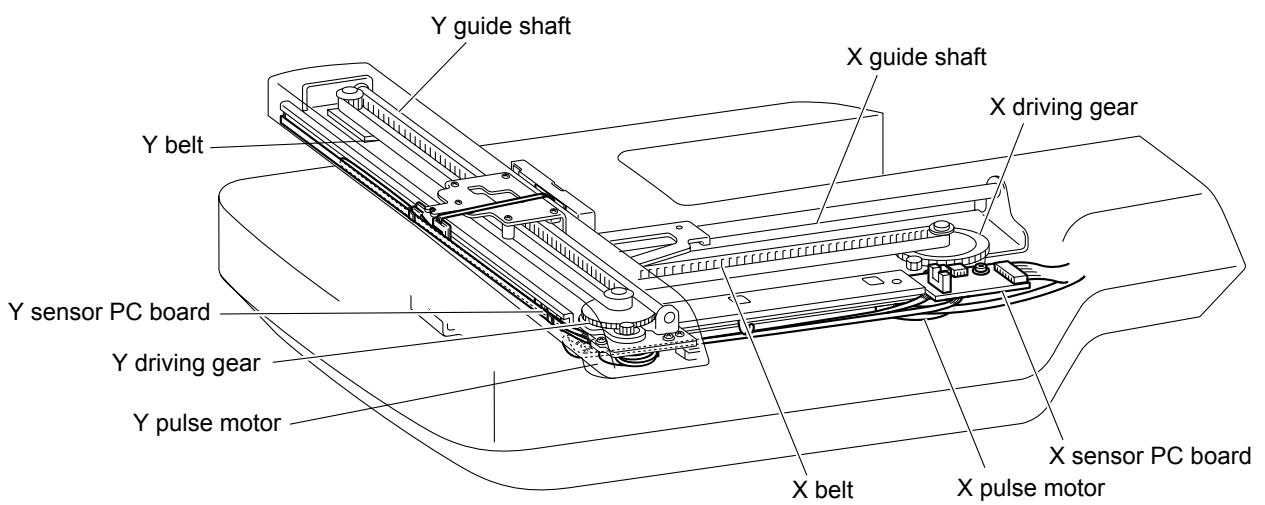
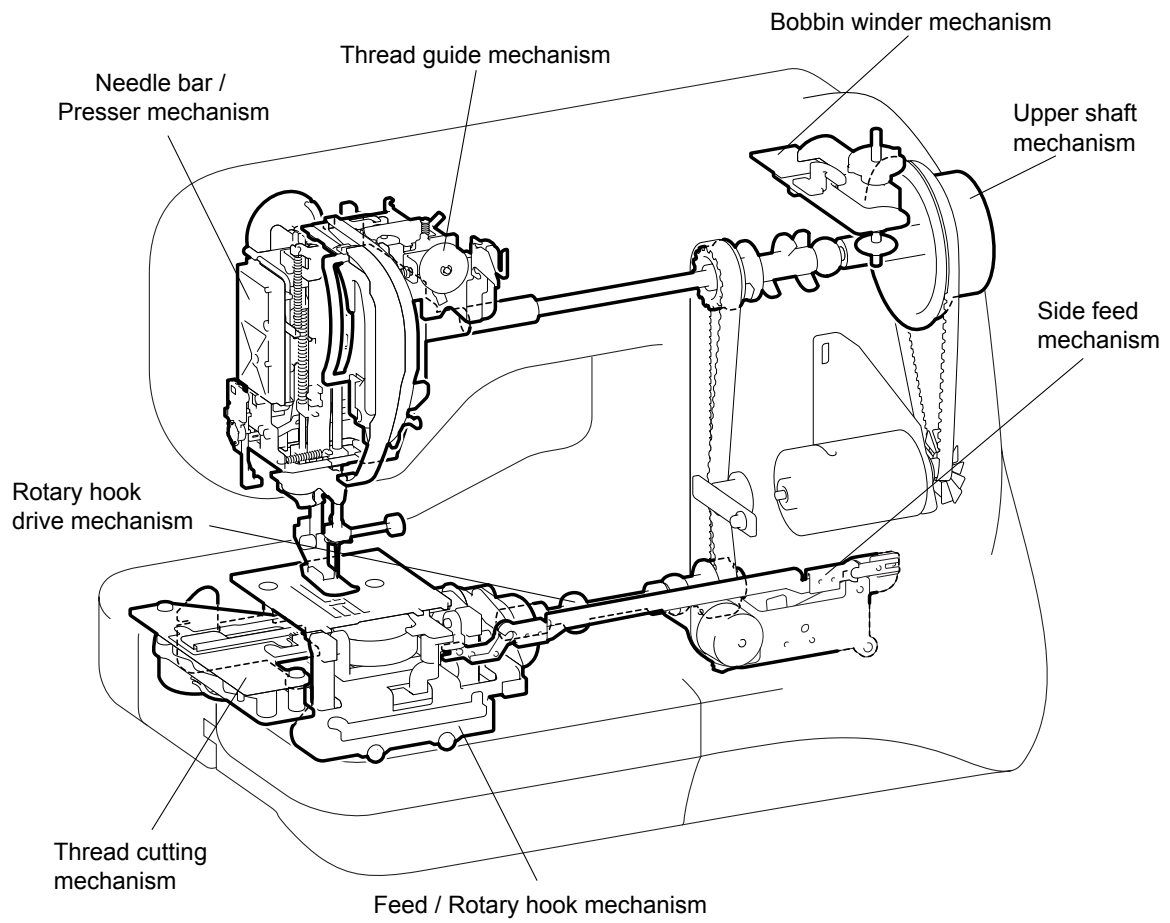

A) Up and down movement of needle bar, movement of thread take-up lever and zigzag mechanism

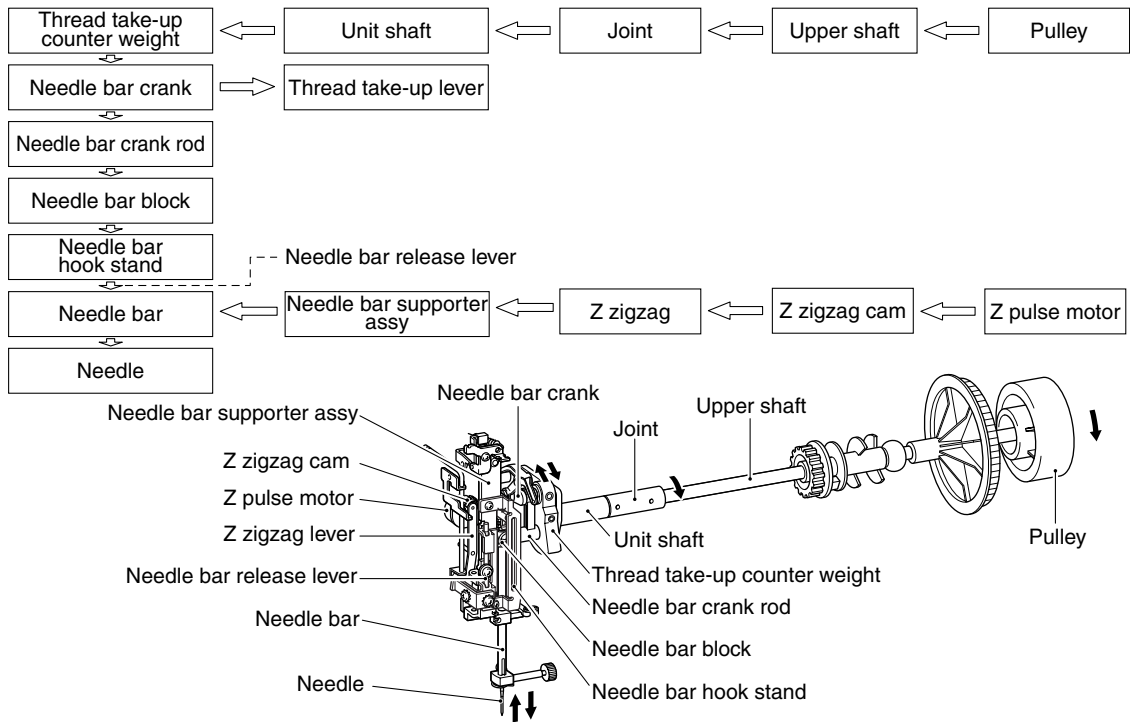

B) Movement of feed dog and bobbin

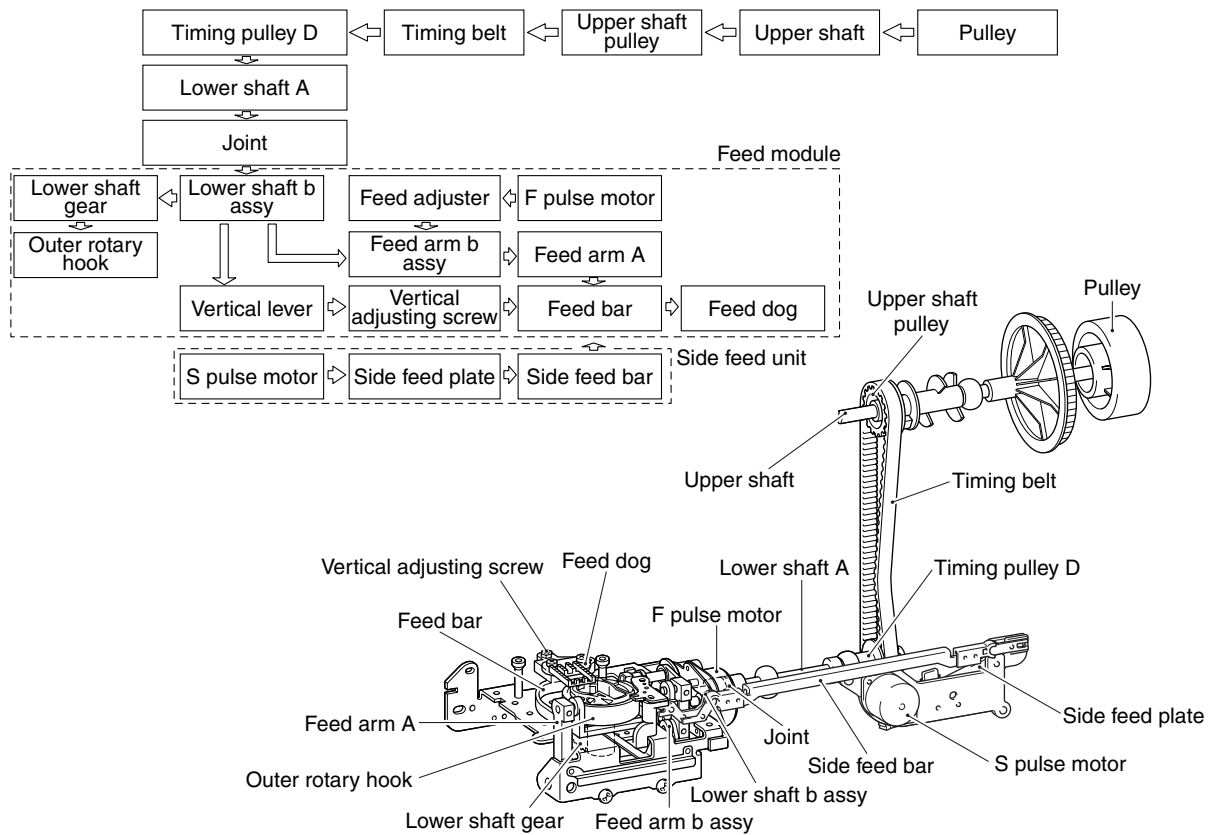

# Outline of Mechanism    Positions of electronic components

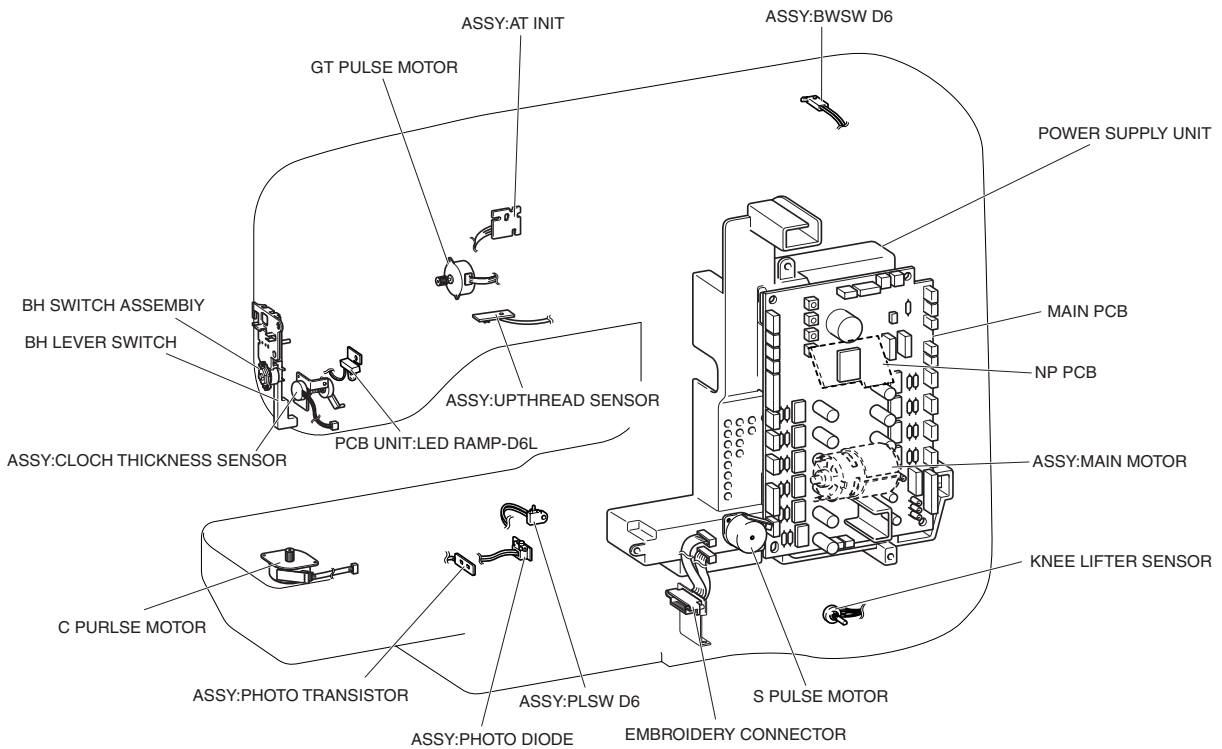
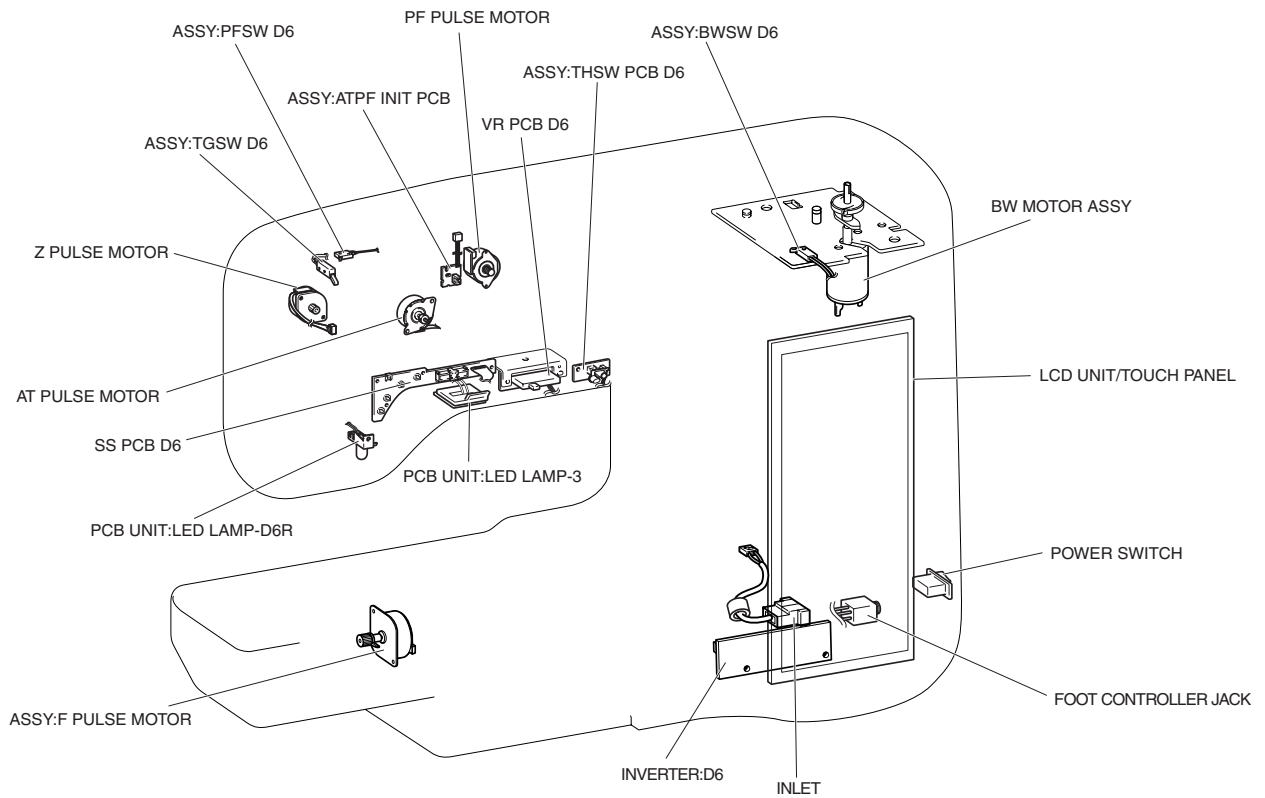



Start/Stop (SS) Switch . . . . .	Switch for starting and stopping the sewing machine. The machine operates at a slow speed while the switch is being held down.
Reverse switch . . . . .	This switch is for backtracking or ending a seam. If the switch is pushed, it makes three to four stitches in that place and stops automatically. If the switch is held down, it sews at a slow speed in the reverse direction as long as the switch is held.
Raise needle switch . . . . .	This switch toggles the needle between the up and down positions.
Cut thread switch . . . . .	This switch is for cutting the thread. If the switch is pressed, the thread is cut regardless of the position of the needle, and the machine stops with the needle up.
Raise Presser Switch . . . . .	This switch toggles the presser foot between the up and down positions.
Touch Panel . . . . .	Used to select pattern and input test mode number required for sewing by simply touching the display on the panel. This simplifies the operation for selecting the desired pattern and number.
Speed Control Lever. . . . .	This lever detects for the speed of sewing.
BH (buttonhole) switch . . . . .	This switch is for detecting the forward and rear ends of the button hole according to the BH presser and lever.
BH (button hole) lever switch . . . . .	This switch detects whether the BH lever is up or down.
NP sensor . . . . .	This sensor detects the drive timing for the pulse motor for the vertical stop position for the needle. It detects the upper shaft angle of rotation using a shutter attached to the upper shaft and an optical sensor.
Speed sensor. . . . .	This sensor detects the rotational speed of the main motor. It detects the upper shaft rotational speed using a shutter attached to the upper shaft and an optical sensor.
Cloth Thickness Sensor . . . . .	This sensor detects the thickness of cloth.
Knee Lifter Sensor . . . . .	This sensor detects the amount of operation of knee lifter.
Presser switch. . . . .	This switch detects the vertical position of the presser foot lifter.
BW (bobbin winder) switch. . . . .	When the bobbin thread is wound, this switch detects whether the bobbin is set for winding or not.



- Needle Plate Switch . . . . . This switch is for detecting needle plate for straight line or not.
- Foot control jack. . . . . This is the jack for plugging in the foot controller when it is used.
- FR assembly and FL assembly LED lamps . White LED lamps for illuminating the work space.
- Up thread PCB assy . . . . . Detects the presence or absence of the upper thread and whether it is cut or not.
- Initial Sensor PCB Assembly. . . . . Detects the original position of pulse motor for the vertical position of presser foot, needle thread switch, and thread tension.
- Photo diode PCB assy.,  
photo transistor PCB assy. . . . . When the bobbin thread is low, this detects it.

The threader provided on this sewing machine is a device for making threading easy, but there are cases where it cannot be used because of the combination of sewing machine thread and needle type.

At present, there are various types of sewing machine thread and sewing machine needles on the market for handling a variety of sewing conditions. Not only may it be impossible to carry out the threading operation due to the combination, but also there is a danger of damaging the threader. Be sure to check the combinations for which it can be used, those for which it cannot and those for which it can but which do not give full performance in the following table to deal with customer claims.

<Cautions>

1. The threader cannot be used with sewing machine thread and needle combinations that are not in the table or those marked with an x.
2. Since combinations marked with an asterisk have a greater possibility of damaging the threader or not working properly, do your best to encourage users to avoid them.
3. When using the threader, lower the presser.
4. When transparent nylon thread is used, use a #14 - #16 sewing machine needle, regardless of what is in the table below.
5. Do not turn the pulley while using the threader.
6. To not push the needle thread lever down when the sewing machine is in use. Not only could the threader be damaged, but this could be a cause of needle breakage and injury.
7. When a #9 sewing machine needle is used, threading may be difficult. (This is caused by variations in needle precision.)
8. If the needle tip is less than 8 mm from the upper surface of needle plate A, threading may not be possible.
9. When a side cutter is being used, the threader cannot be used. Perform the threading operation before attaching the side cutter.

Thread size \ Needle size	# 30	# 50	# 60	# 80	# 100	# 120
#9	×	×	×	○	○	○
#11	×	○	○	○	○	※
#14	×	○	○	○	※	※
#16	※	○	○	※	※	※
#18	※	※	※	※	※	※

# 2 Disassembly

---

Main unit	Main parts .....	2 - 2
	Power unit, motor unit.....	2 - 18
	Thread tension unit.....	2 - 24
	Bobbin winder .....	2 - 33
	Rotary hook driving unit, feed/rotary hook unit, thread cutter unit, side feed unit .....	2 - 39
	Needle-presser unit, needle threader unit, upper shaft unit .....	2 - 42
Modules	Needle-presser module .....	2 - 46
	Feed/rotary hook module.....	2 - 64
	Side feed module.....	2 - 78
	Thread cutter module .....	2 - 81
Embroidery	Main parts .....	2 - 86

Main parts location diagram

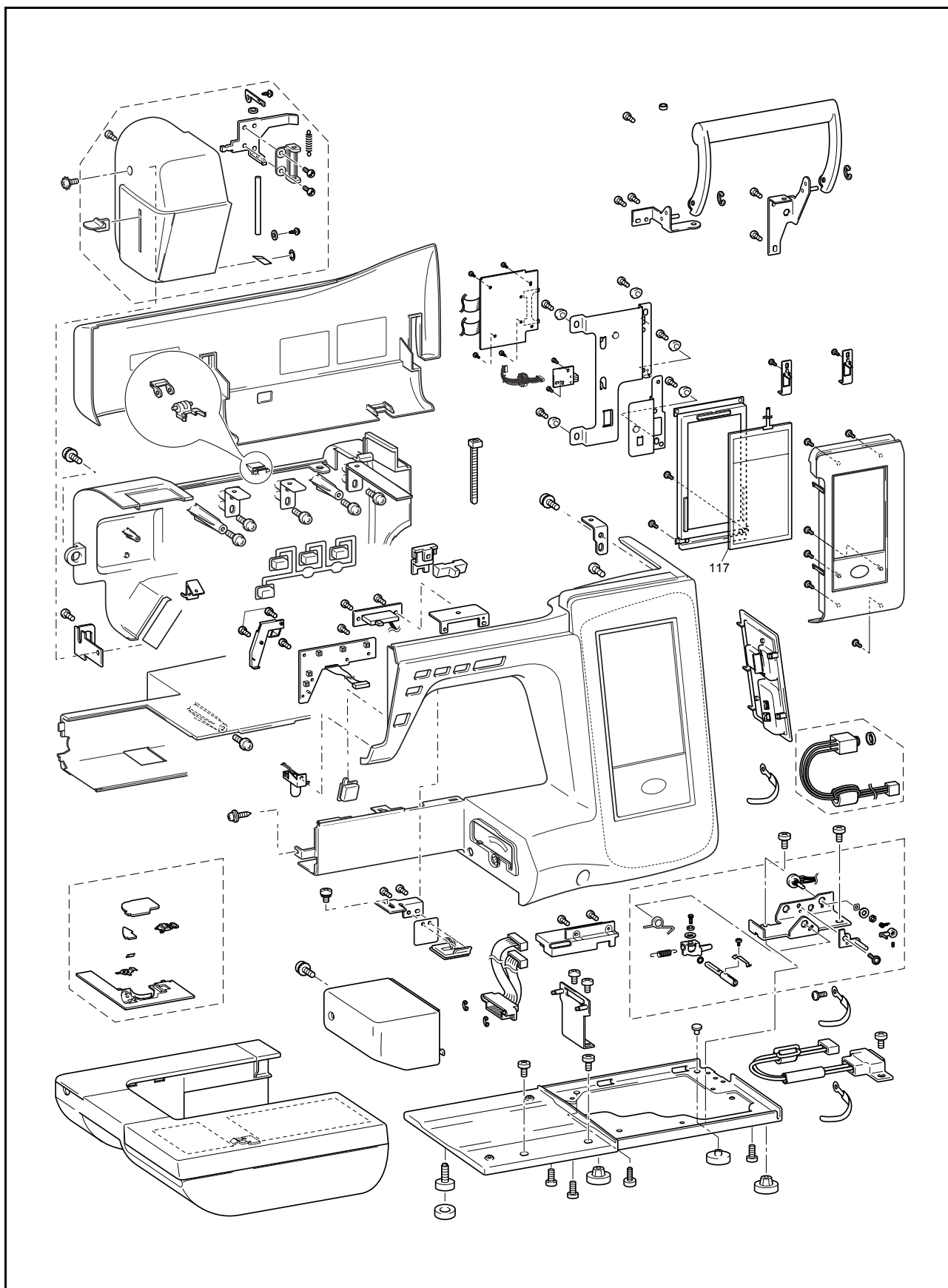

**1** Accessory table removal

1. Slide the accessory table ① to the left, and remove it.

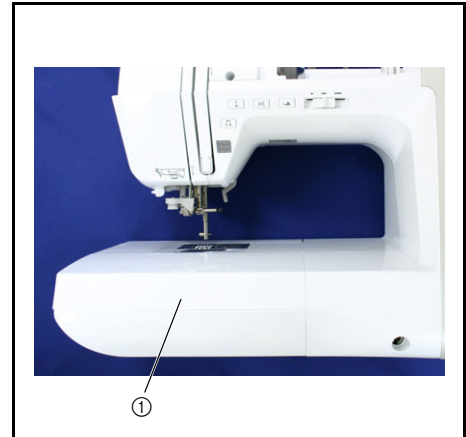
**2** Top cover removal

1. Turn the handle ①, and open the top cover ②.
2. Remove the top cover ② from the hinge ③ of the main unit.

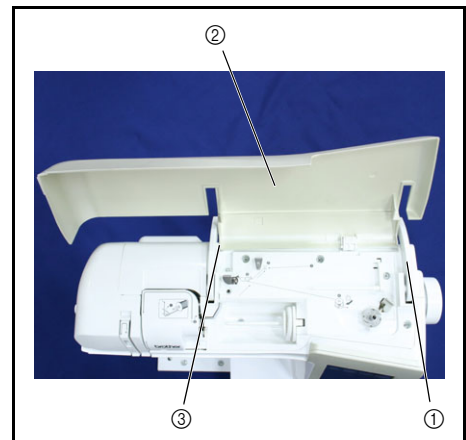
**3** Needle plate B assembly removal

1. Slide the needle plate B assembly ① toward you, and then remove it.

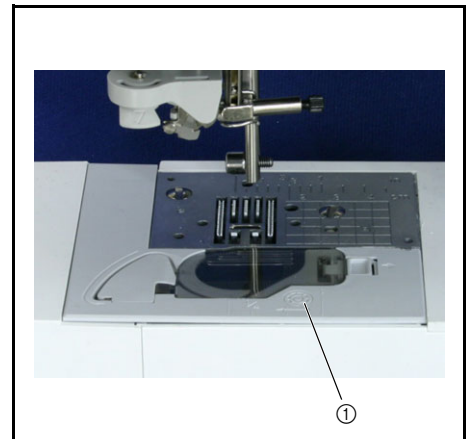

#### 4 Needle plate B ASSY disassembly

1. Slide the slide button ① to the right, and then remove the needle plate cover ②.
2. Reverse the needle plate B assembly ③. Press the tab ④ on the cutter cover with your finger, and then remove the cutter cover ⑤.
3. Remove the spring plate ⑥ on the rear of the cutter cover, and then remove the NT lower thread cutter ⑦.
4. Remove the slide button ①.

**\*Key point**

- Remove the hooks (2 locations) on the rear of the slide button ①.

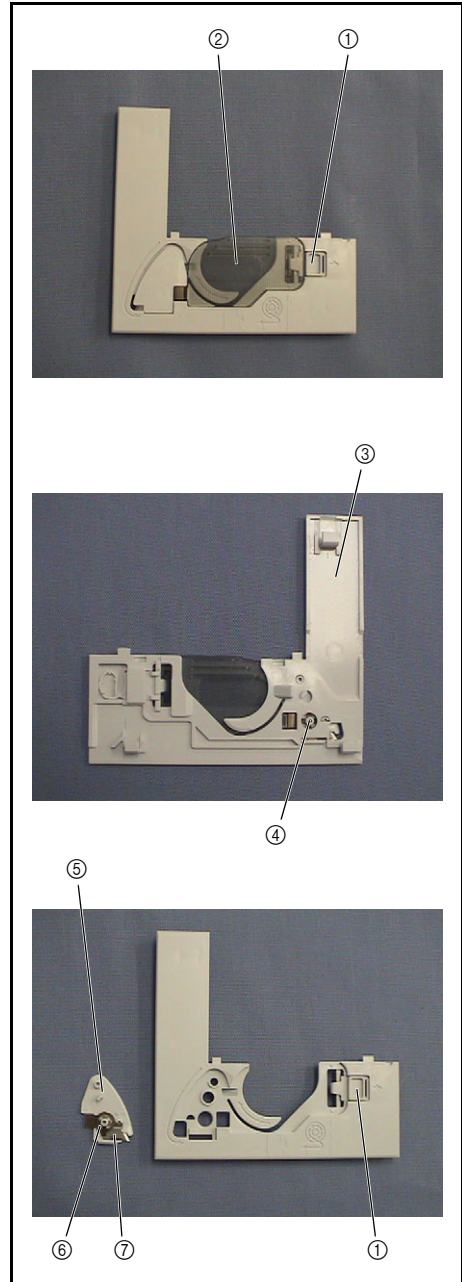

## 5 Face plate assembly removal

1. Remove the screws ① and ② (rear and side respectively), and then remove the face plate assembly ①.
2. Cut the band ②, and remove the screw ③, and then remove the face plate holder ③.

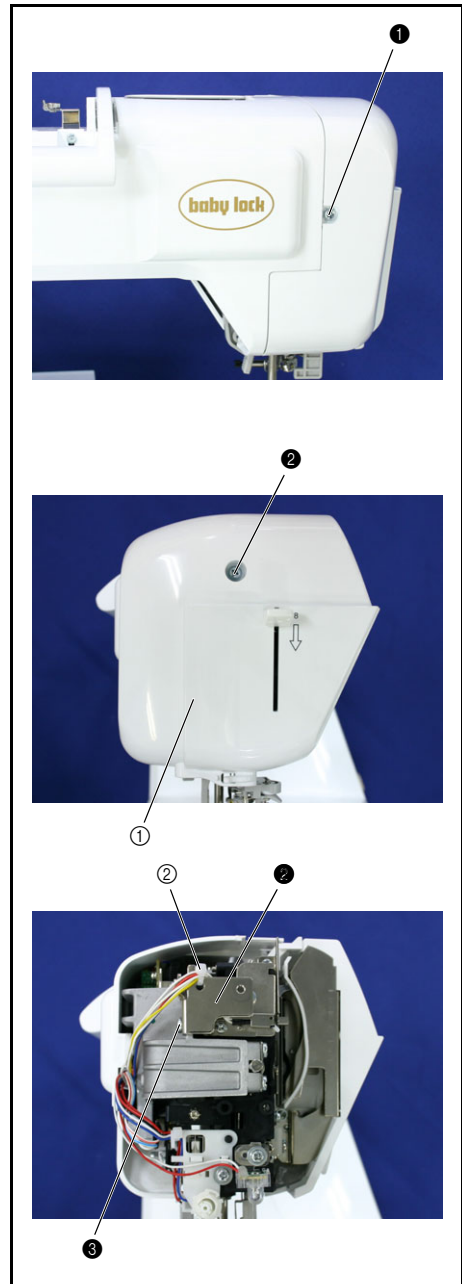

## 6 Face plate assembly disassembly

1. Remove the needle thread lever knob ①.
2. Remove the retaining ring (CS), and then remove the NT lower thread cutter ②.
3. Remove spring **S67**.
4. Remove the screw ①, and then remove the shaft presser plate ③.
5. Remove the screws ②, and then remove the plain washer ④.
6. Remove the needle thread lever shaft ⑤.
7. Remove the rubber washer ⑥ and the needle thread lever assembly ⑦ from the needle thread lever shaft ⑤.
8. Remove the 2 screws ③, and then remove the needle thread slider ⑧ from the needle thread lever assembly ⑦.

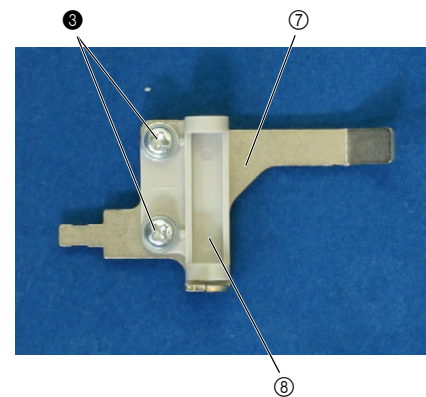
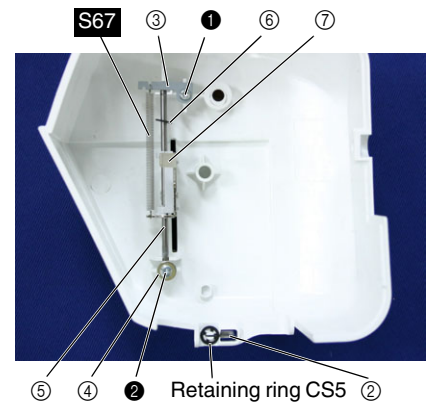
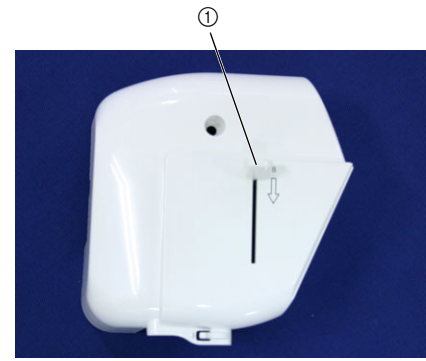

## 7 Front thread guide cover removal

1. Remove the screw ①, and then remove the front thread guide cover ①.

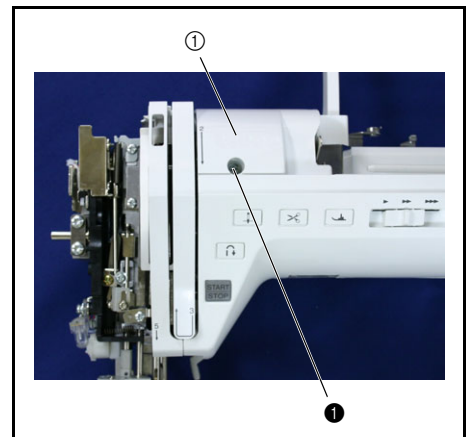



## 8 Free arm cover removal

1. Remove the screw ❶ on the rear of the main unit, and then remove the free arm cover ❶.

### \*Key point

- Remove the hook on the free arm cover ❶ from the front cover.

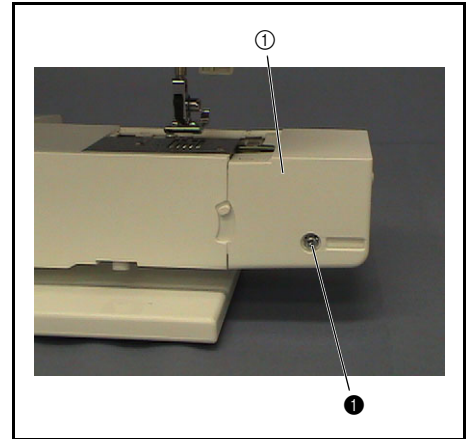

## 9 Base plate cover removal

1. Remove the 2 screws ❶, and then remove the base plate cover ❶.

### \*Key point

- Slide the base plate cover ❶ to the left, and then remove the hooks (4 locations) from the base plate.

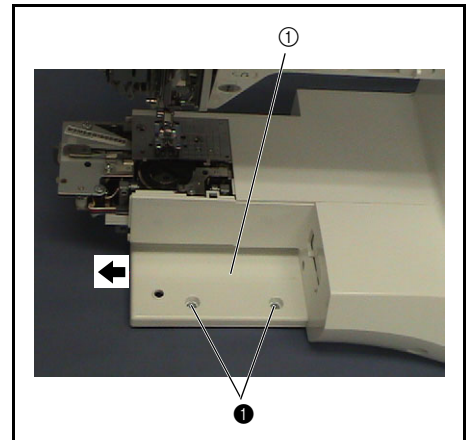

## 10 Bobbin winder removal

1. Remove the 5 screws ❶ and screw ❷, and then remove the bobbin winder module ❶.
2. Disconnect the 2 lead wire connectors ❷ from the main PCB of the bobbin winder module ❶.

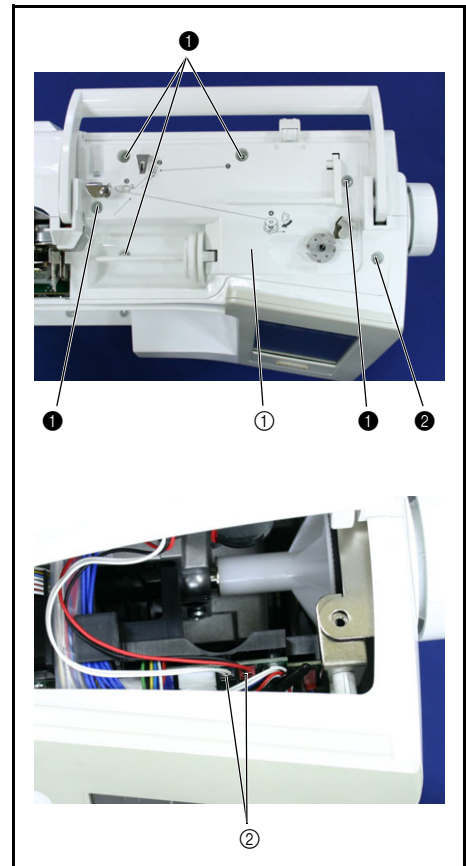

## 11 Front cover removal

1. Remove the screw ①②, and then remove the front cover.

**\*Key point**

- Remove the hooks ① (2 locations) from the base plate and the hook ②③ from the rear cover.
2. Disconnect the 2 lead wire connectors ④, and the 2 flat cable ④ from the main PCB of the front cover.



①

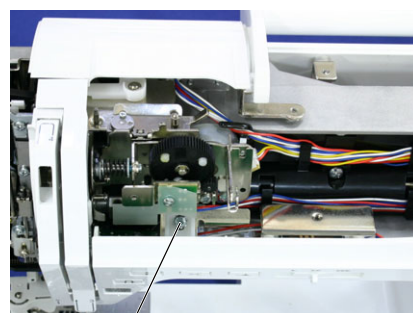

②



①

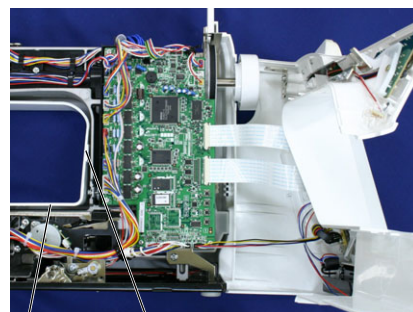

③

②

**12** Front cover disassembly (connector removal)

1. Cut the band ①.
2. Remove the 4 connectors ② from the card PCB ③.

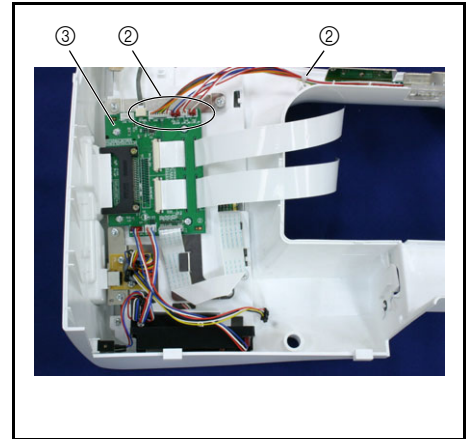
**13** Front cover disassembly (LED lamp R removal)

1. Remove the retaining ring (CS4), and then remove LED lamp R ①.

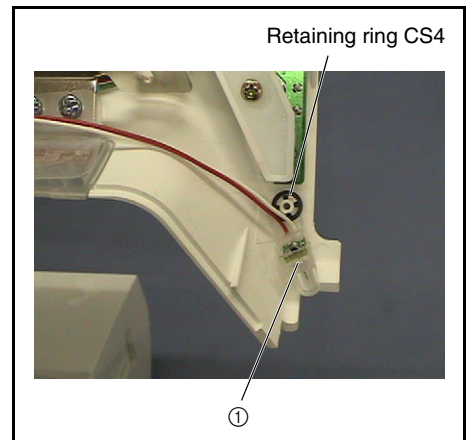
**14** Front cover disassembly (LED lamp 3 removal)

1. Remove the 2 screws ①, and then remove LED lamp 3 ①, adjusting plate B ② and insulation sheet ③.

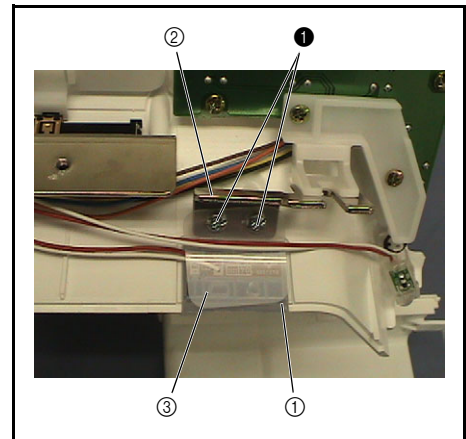
**15** Front cover disassembly (VR PCB assembly removal)

1. Remove the 2 screws ①, and then remove the VR PCB assembly ① and plate C ②.

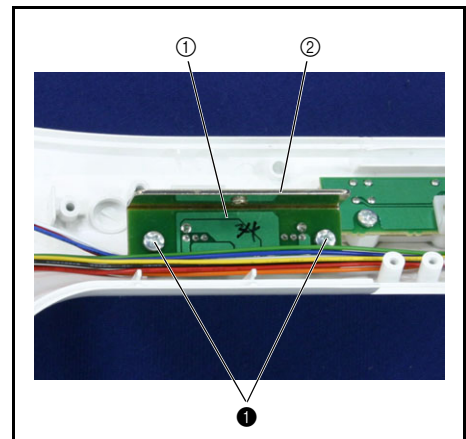

**16** Front cover disassembly (SS PCB assembly removal)

1. Remove the 2 screws ❶, and then remove the S holder ❶.
2. Remove the 2 screws ❷, and then remove the SS PCB assembly ❷.

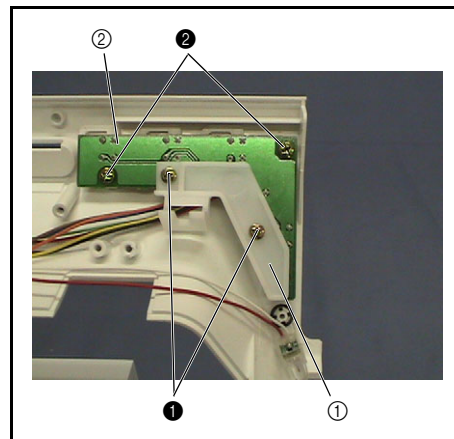
**17** Front cover disassembly (button removal)

1. Remove the button ❶ and SS-button ❷.

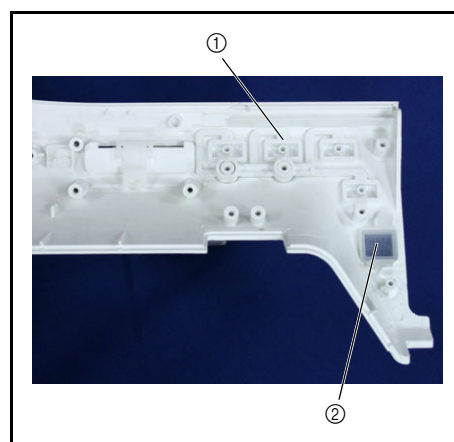
**18** Front cover disassembly (plate D removal)

1. Remove the screw ❶, and then remove plate D ❶.

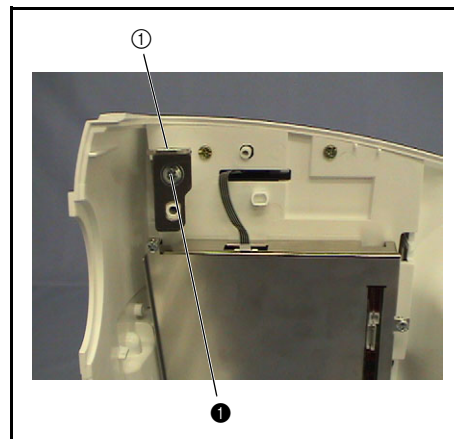

**19** Front cover disassembly (inverter D6 assembly removal)

1. Remove the 2 screws ❶, and the clip ❶ from the left screw, and then remove the inverter D6 assembly ❷.
2. Remove the foot controller jack assembly's ferrite core ❸ from the clip ❶.
3. Disconnect the inverter lead wire (D6M) connector ❺ and the LCD lead wire connector ❻ from the inverter ❹.
4. Remove the 2 screws ❷, and then remove the inverter ❹.

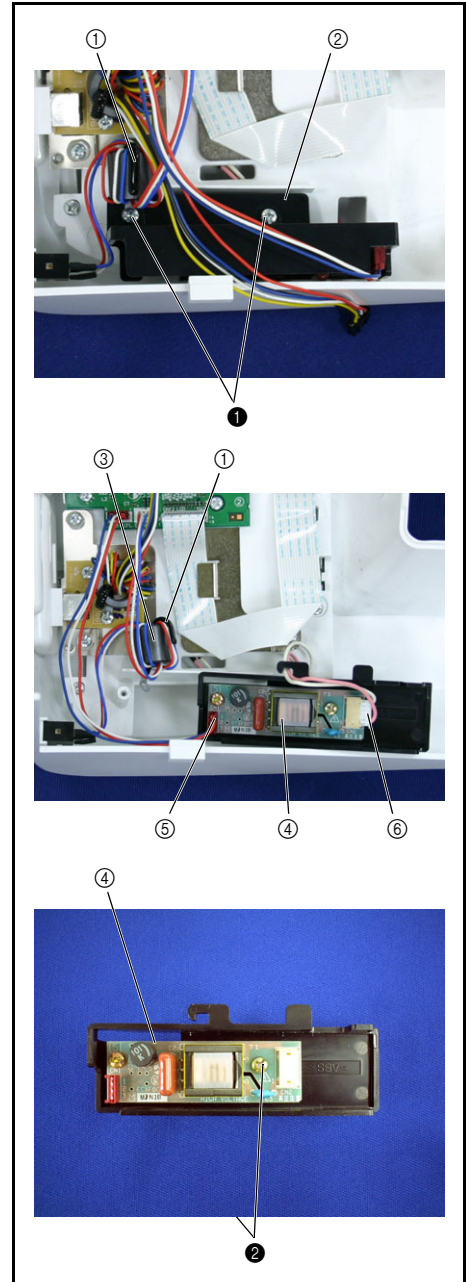



**20** Front cover disassembly (PCB holder assembly removal)

1. Remove the all connectors, FFC ③, and FFC ④.

**\*Key point**

- Release the knob when removing the FFC ③.

2. Remove the 3 screws ①, and then remove the 3 board pressers and the card PCB holder ①.
3. Remove the 2 screws ②, and then remove the 2 board pressers and the USB PCB holder ②.
4. Remove the 4 screws ③, and then remove the card PCB ⑤ from the card PCB holder ①.
5. Remove the 2 screws ④, and then remove the USB PCB ⑥ from the USB PCB holder ②.

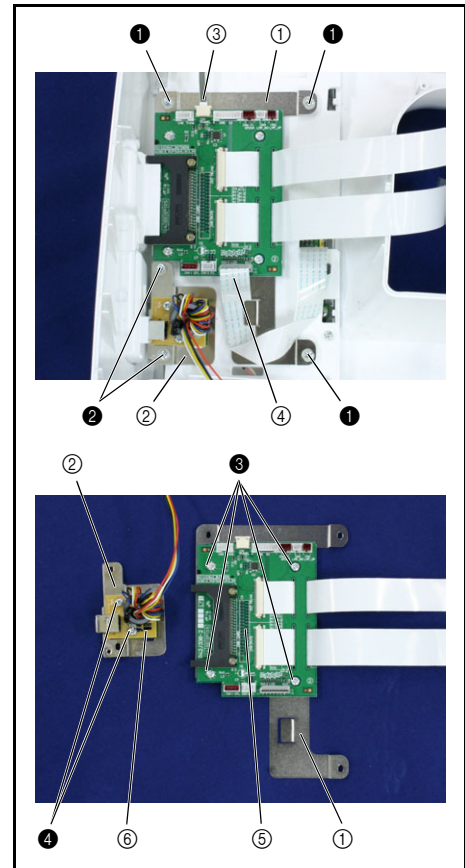
**21** Front cover disassembly (card PCB cover assembly removal)

1. Remove the card PCB cover assembly ①, and then remove the pen holder ②.

**\*Key point**

- Remove the hooks (2 locations) from the inside of the front cover.

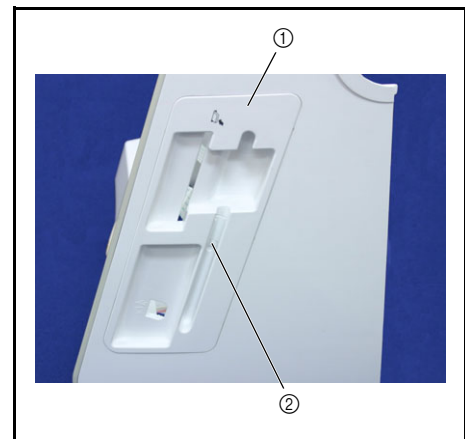
**22** Front cover disassembly (connector cover removal)

1. Remove the retaining ring (CS4), and then remove the connector cover ①.

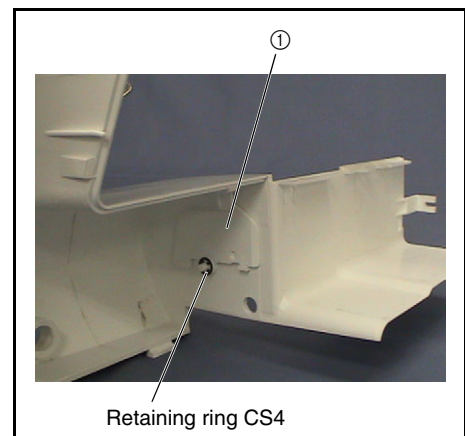

**23** Front cover disassembly (foot controller jack assembly removal)

1. Use a jack screwdriver to remove the foot controller jack assembly ①.

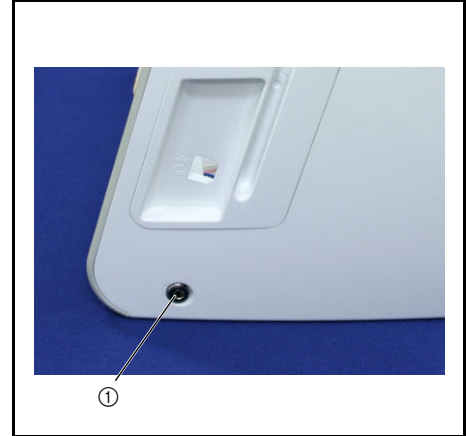
**24** Front cover disassembly (LCD holder assembly removal)

1. Remove the 4 screws ①.
2. Remove the hooks ② (2 locations) on the left side of the LCD holder assembly ①, and then remove the LCD holder assembly ① from the front cover.

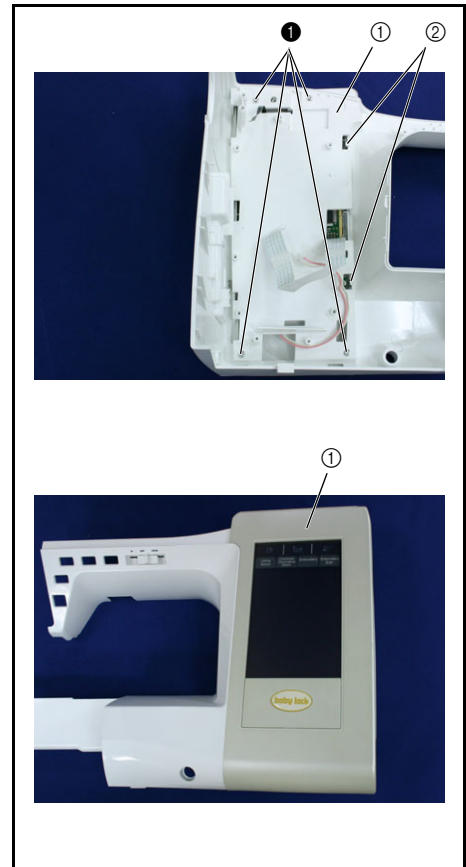

**25** Front cover disassembly (SV keytop removal)

1. Pull out the SV keytop ①.
2. Remove the SV joint plate ② on the rear of the front cover.

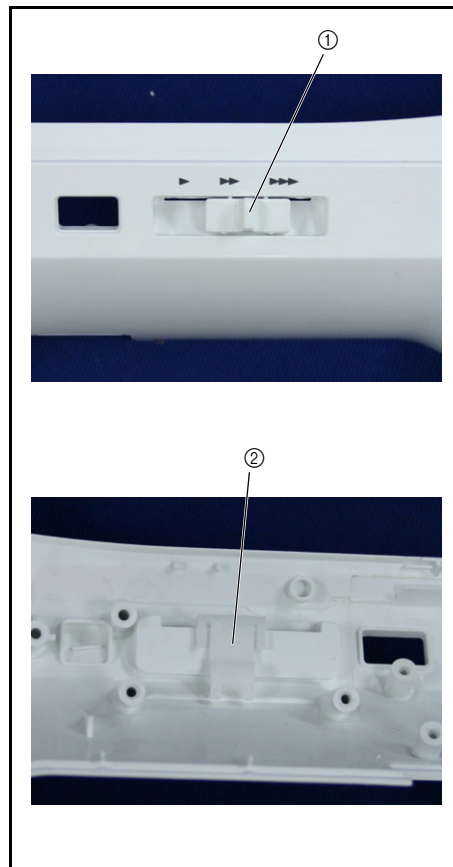



**26** Front cover disassembly (LCD assembly removal)

1. Remove the 2 screws ①, and then remove the LCD presser ①.
2. Remove the 2 screws ②, and then remove the LCD ② and the touch panel ③.
3. Remove the 2 screws ③, and then remove the DECO plate ④ from the information panel ⑤.

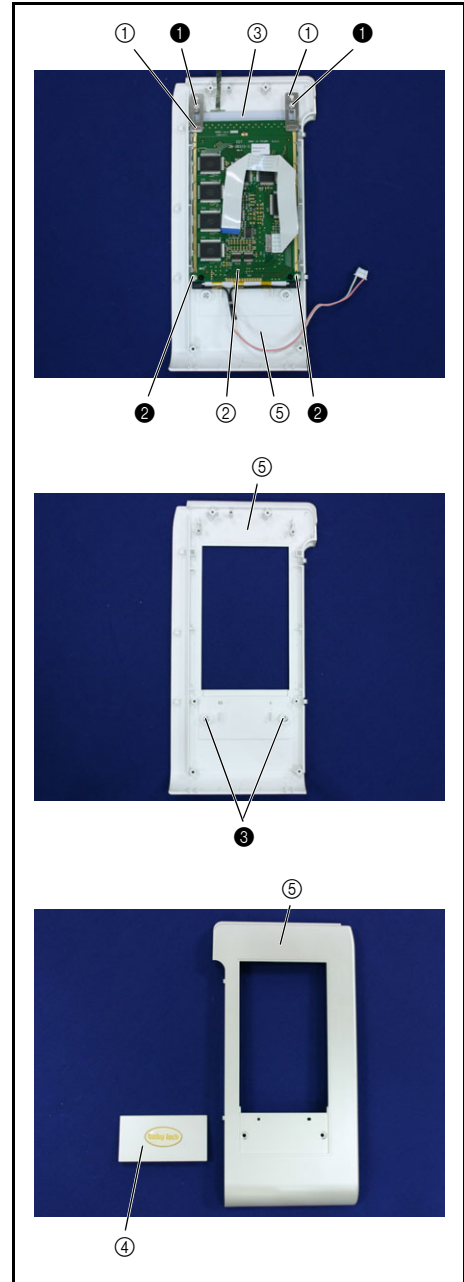

## 27 Rear cover removal

1. Press down the presser foot lifter ①.
2. Remove the 3 screws ❶, and then remove the rear cover.

**\*Key point**

- Remove the hooks ② (2 locations) from the base plate.

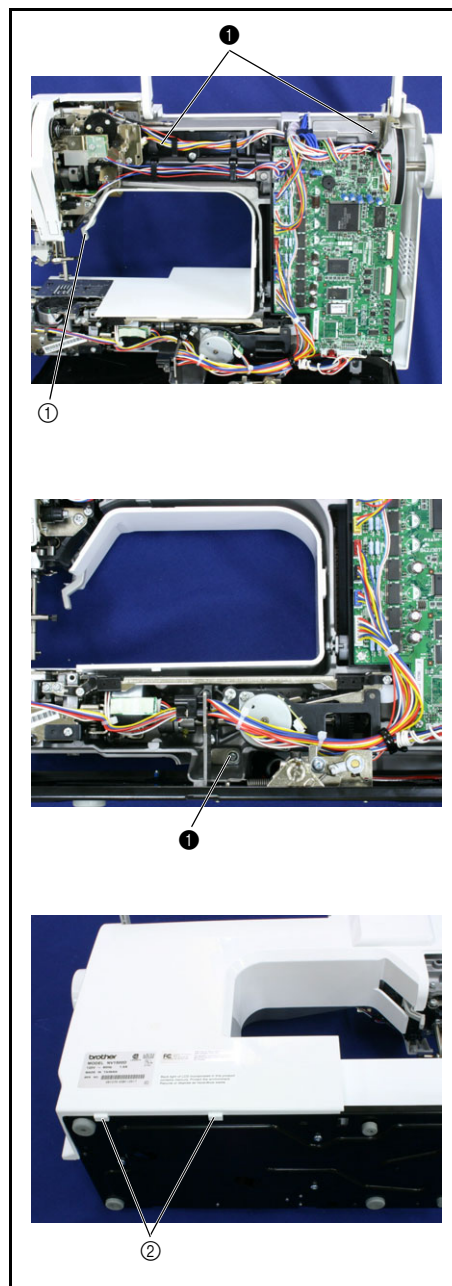

## 28 Rear cover disassembly (plate B removal)

1. Remove the screw ❶, and then remove plate B ①.

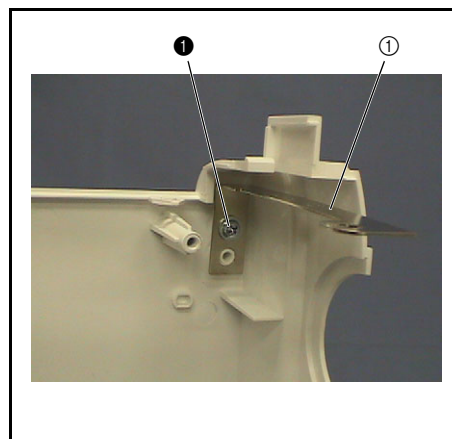

**29** Rear cover disassembly (plate A removal)

1. Remove the 2 screws ❶, and then remove plate A ① (2 locations).

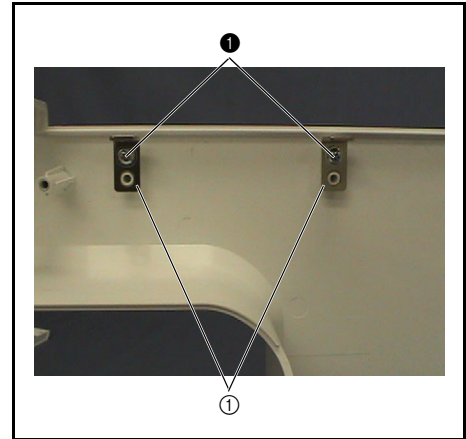
**30** Drop cover removal

1. Pull out the drop cover ① from the rear of the main unit.

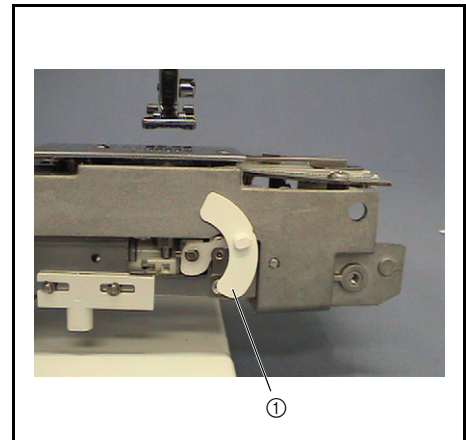
**31** Handle assembly removal

1. Remove the 4 screws ❶, and then remove the handle assembly ①.

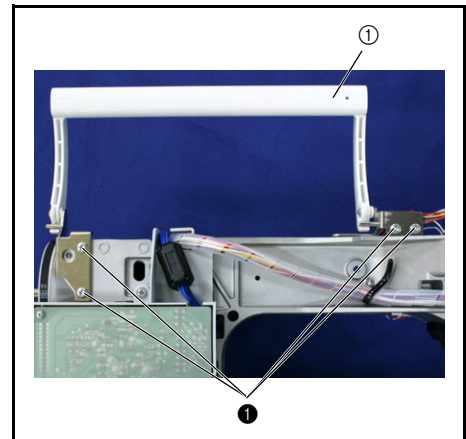
**32** Handle ASSY disassembly

1. Remove the 2 retaining rings (E4), and then remove the handle holder R assembly ① and handle holder L assembly ② from the handle ③.

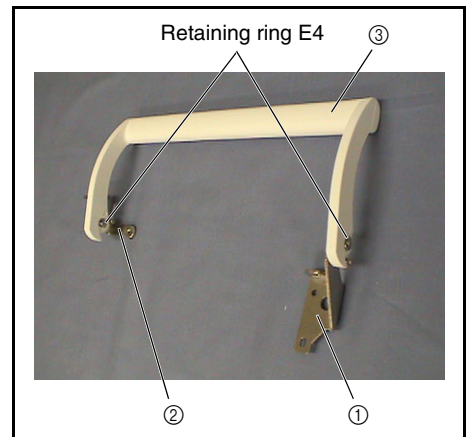

Power unit, motor unit location diagram

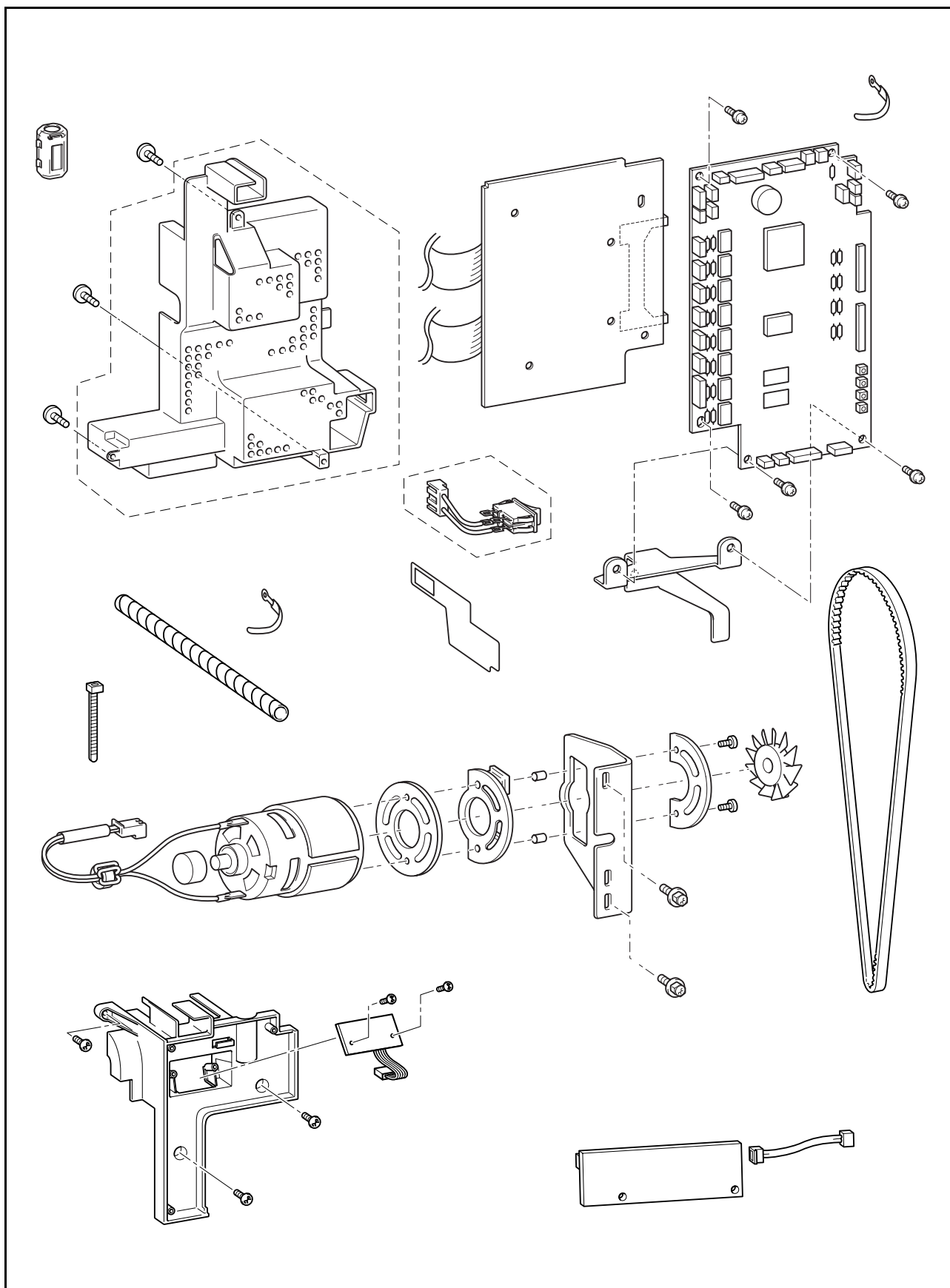

## 1 Power PCB assembly removal

1. Disconnect all connectors from the main PCB ①.
2. Remove the motor cord connector ③ and the inlet cord connector ④ from the power PCB assembly (D6US) ②.
3. Remove the 3 screws ①, and then remove the power PCB assembly (D6US) ②.

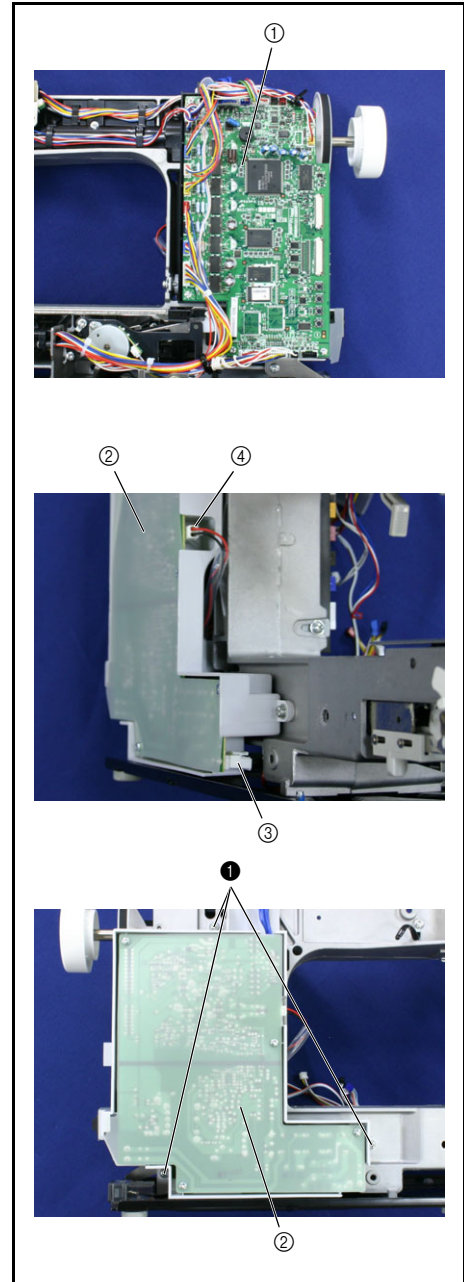

## 2 Power switch assembly (D6)

1. Remove the power switch assembly (D6) ② and the insulator sheet (S) ③ from the power PCB assembly (D6US) ①.
2. Remove the connector ④ of the power switch assembly (D6) ② from the power PCB assembly (D6US) ①.

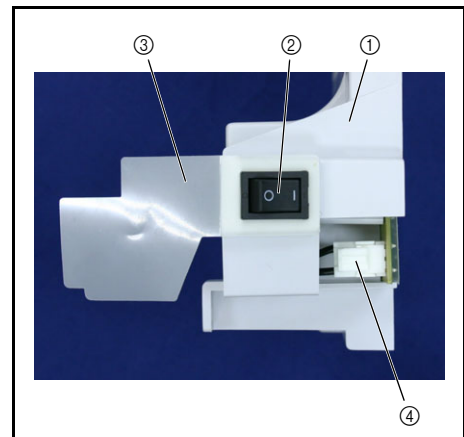

### 3 Base plate assembly removal

1. Remove the 3 screws ❶, and then remove the base plate assembly ①.

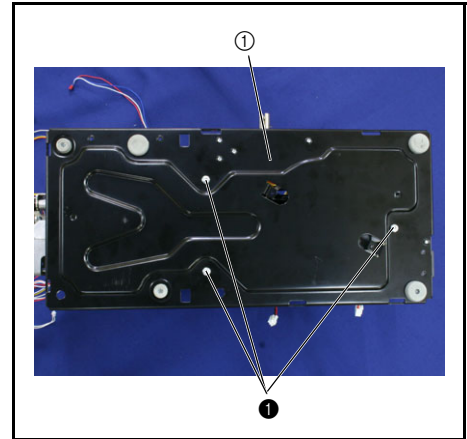

### 4 Inlet assembly removal

1. Remove the screw ❶, and then remove the inlet assembly ①.

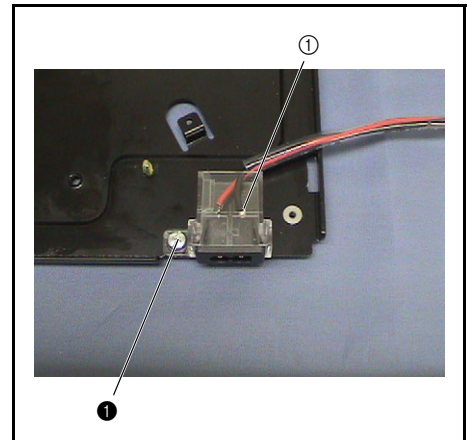

### 5 Knee lifter assembly removal

1. Remove the 2 screws ❶, and then remove the knee lifter assembly ①.

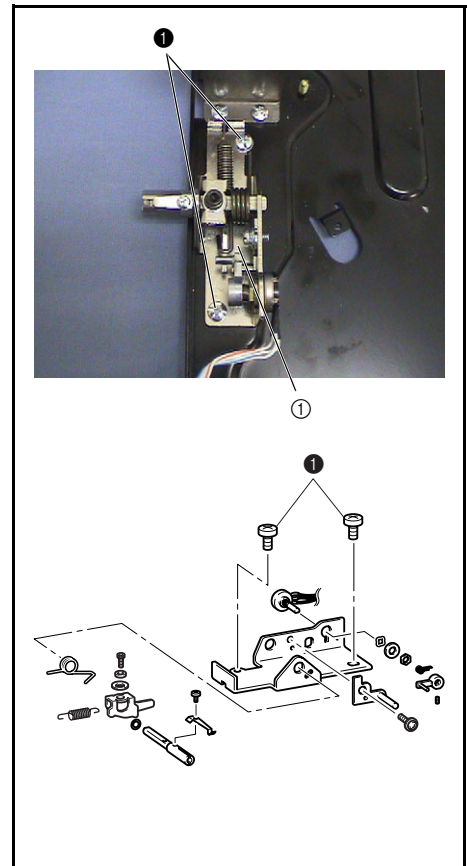



## 6 Embroidery unit connector assembly removal

1. Remove the 2 screws ❶, and then remove the embroidery unit connector assembly ❶.

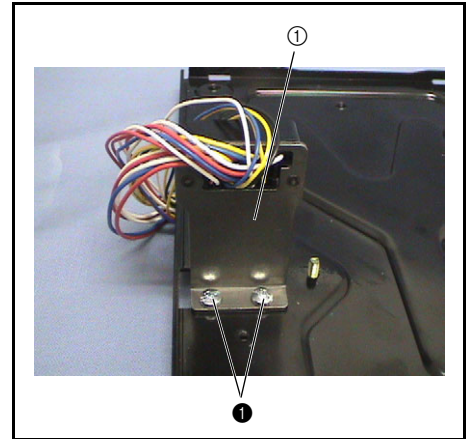

## 7 Main PCB assembly removal

1. Remove the 3 screws ❶, clip (right upper screw), and 2 screws ❷, and then remove the main PCB assembly ❶.
2. Remove the screw ❸, and then remove the PCB fixed plate ❷.

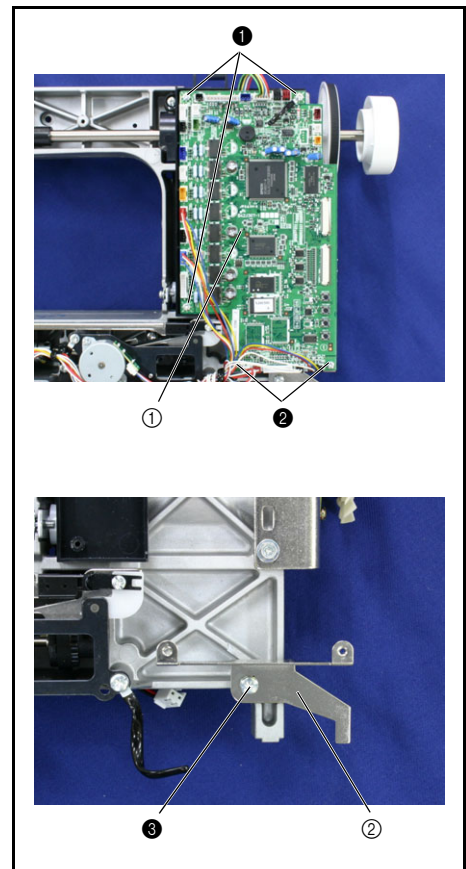

## 8 NP PCB assembly (D6) removal

1. Remove the 3 screws ❶, and then remove the NP PCB assembly (D6) ❶.

### NOTE

- Remove the NP PCB assembly (D6) carefully to avoid damaging the sensor on the rear of the assembly.

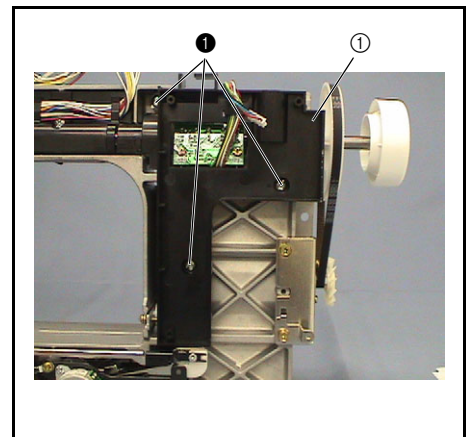

## 9 NP PCB assembly (D6) disassembly

1. Remove the lead wire of the NP PCB assembly (D6) ① from the guide ② of the PCB holder.
2. Remove the 2 screws ❶, and then remove the NP PCB assembly (D6) ③.

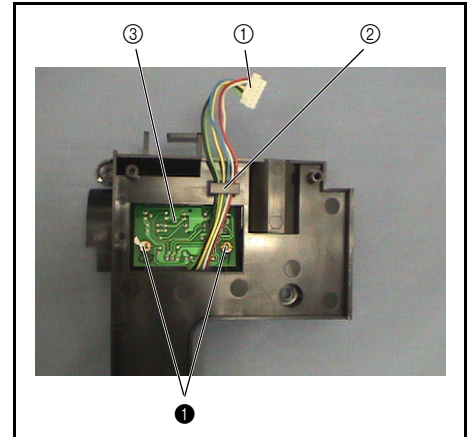

## 10 Main motor assembly removal

1. Remove the motor fan ④.

### NOTE

- Be careful removing the motor fan because the wings of the fan are very fragile.

2. Remove the 2 screws ❶, and then remove the main motor assembly ① and PCB holder R ②.
3. Remove the timing belt (motor belt) ③.

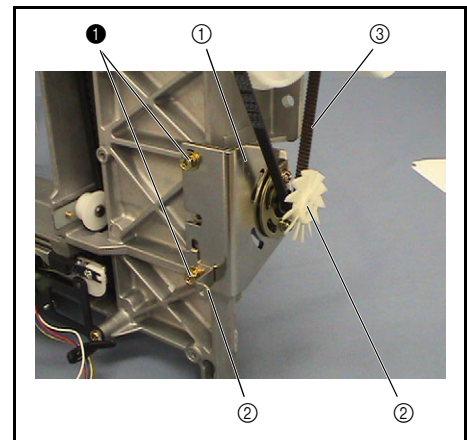



**11** Main motor assembly disassembly

1. Remove the 2 screws ❶, and remove the main motor assembly ❶, the motor spacer presser ❷, and the motor holder spacer ❸.
2. Remove the fender rubber ❸ from the motor holder ❹.
3. Remove the 2 spacer 4x7 ❺ from the fender rubber ❸.

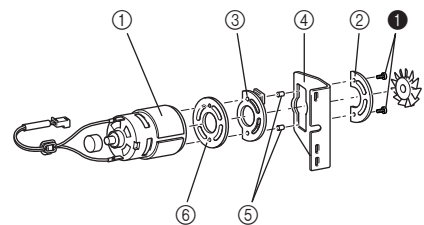
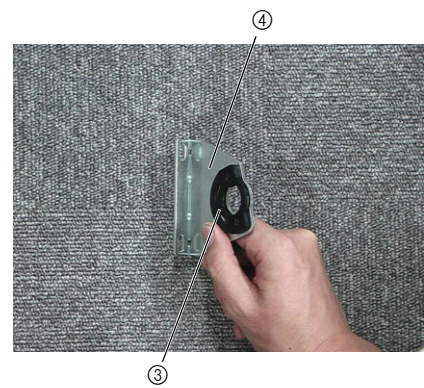
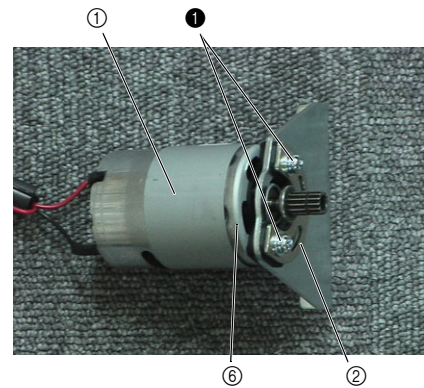

Thread tension unit location diagram

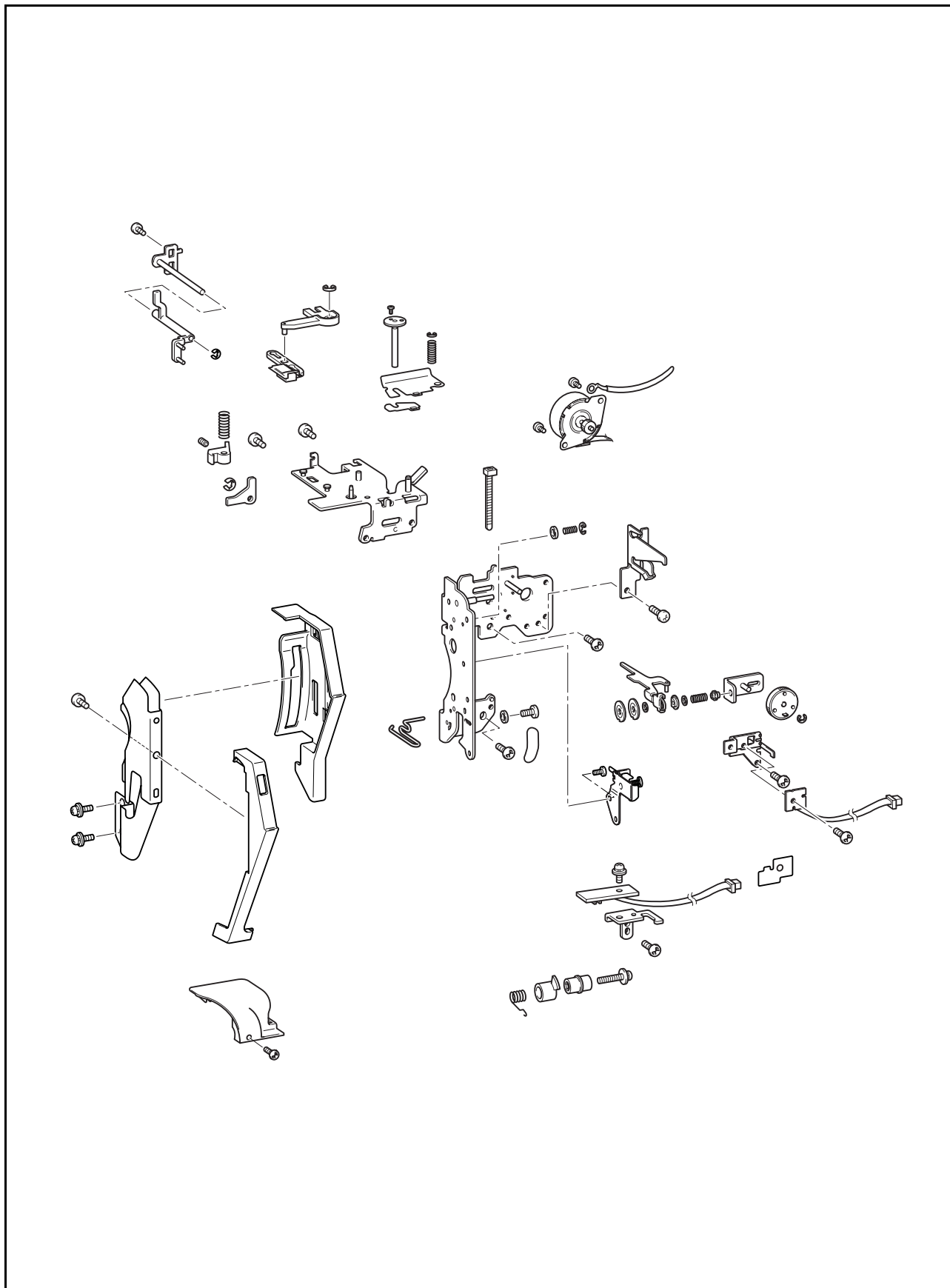

**1 Thread guide assembly removal**

1. Remove the lead wires from the hooks of the upper shaft cover ②.
2. Remove the 2 screws ❶, and then remove the thread guide assembly ❶.

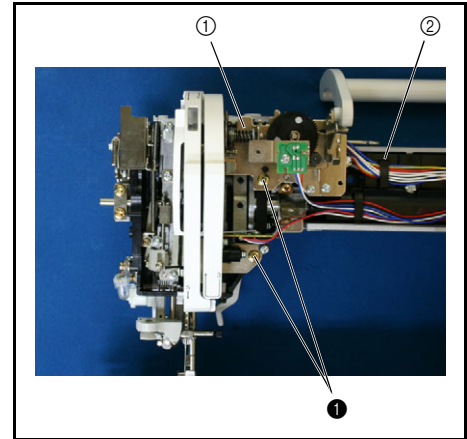
**2 Thread guide removal**

1. Remove the screw ❶, and then remove the thread guide ❶.

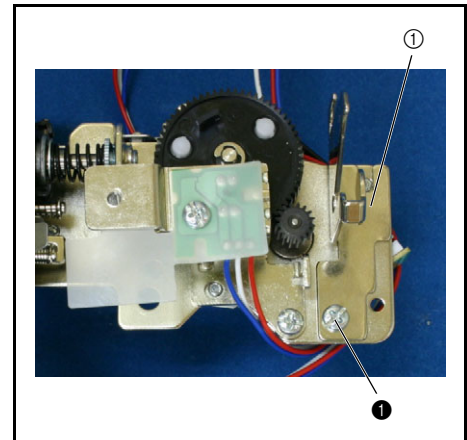
**3 Upper thread PCB assembly removal**

1. Remove the screw ❶, and then remove the upper thread PCB assembly ❶.

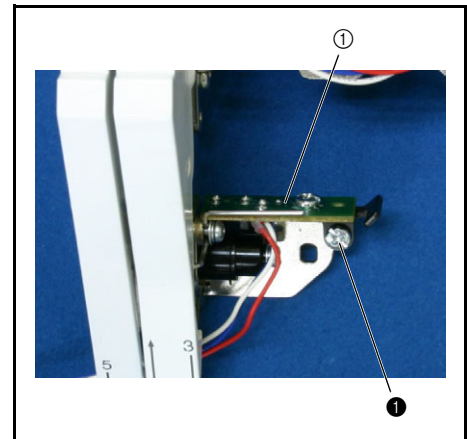
**4 Upper thread PCB ASSY disassembly**

1. Remove the screw ❶, and then remove the upper thread PCB assembly ❶ from the thread sensor holder ②.

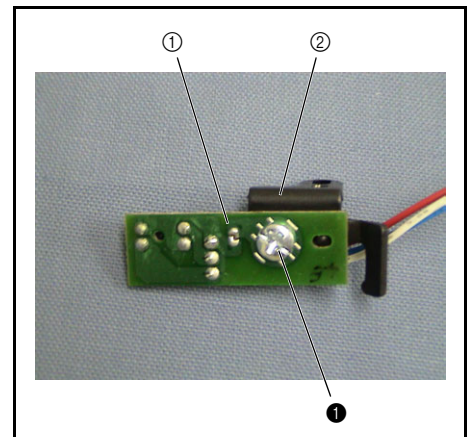

**5** AT INIT PCB assembly removal

1. Remove the screw ❶, and then remove the AT INIT PCB assembly ❶.

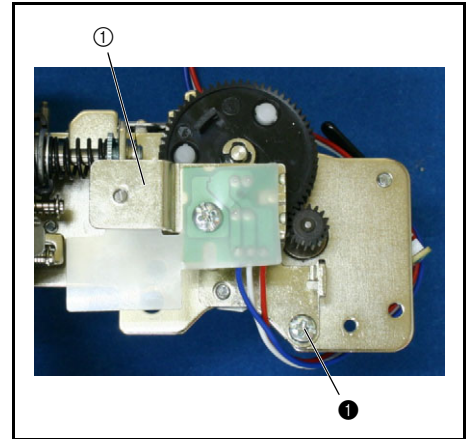
**6** AT INIT PCB ASSY disassembly

1. Remove the screw ❶, and then remove the AT INIT PCB assembly ❶ and the insulation sheet ❷ from the AT pulse motor sensor holder ❸.

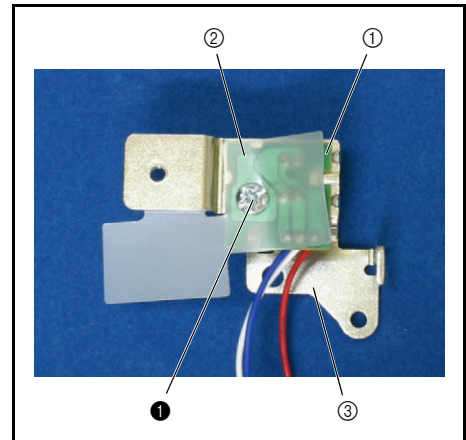
**7** Thread guide cover assembly removal

1. Remove the 2 screws ❶, and then remove the thread guide cover assembly ❶.

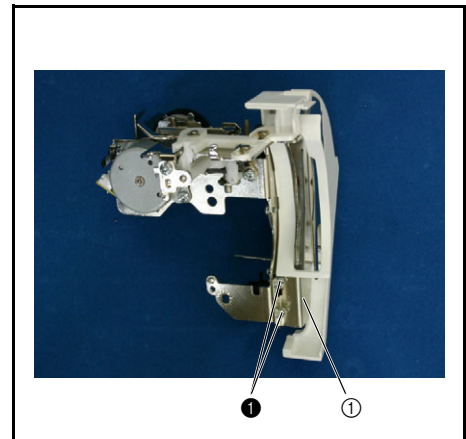

**8** Thread guide cover ASSY disassembly

1. Remove the screw ❶, and then remove the thread guide ❷ from the thread guide cover assembly ❸.

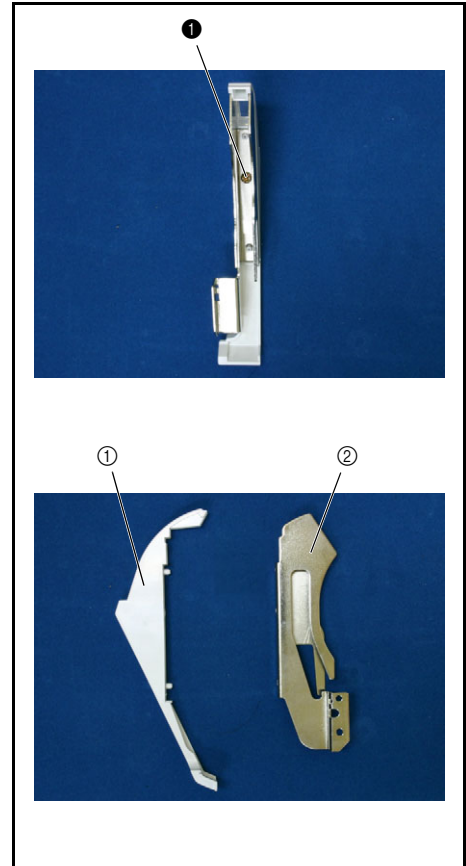
**9** Thread guide cover removal

1. Remove the hook ❶, and then remove the thread guide cover ❷.

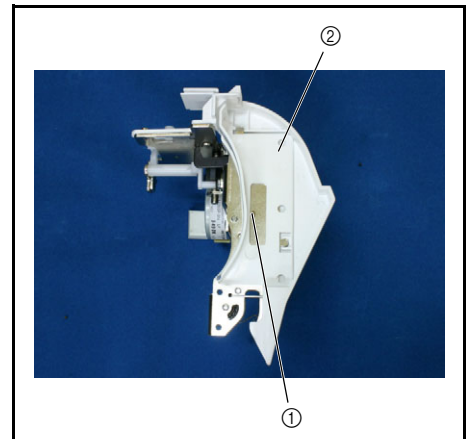
**10** Thread guide shutter link A assembly removal

1. Remove the screw ❶, and then remove the thread guide shutter link A ❷.

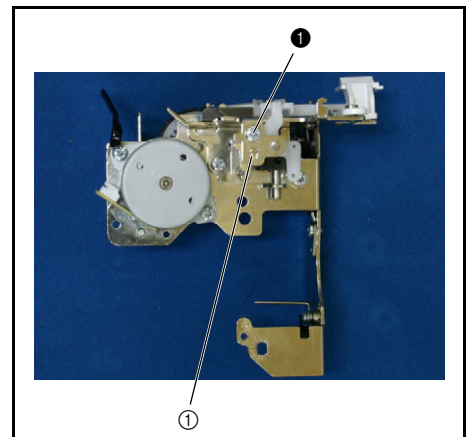

**11** Thread guide shutter link A ASSY disassembly

1. Remove the retaining ring (E3), and then remove the link A shaft plate assembly ② from the thread guide shutter link A ①.

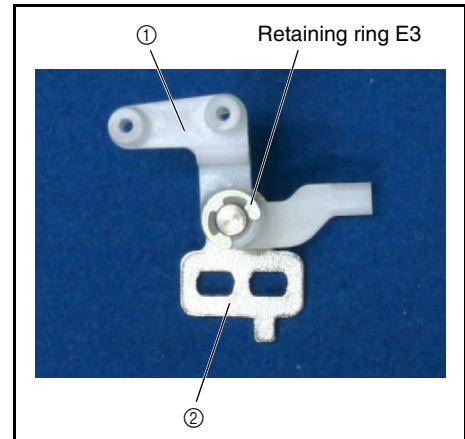
**12** Plate assembly removal

1. Remove the screw ①, and then remove the plate assembly ①.

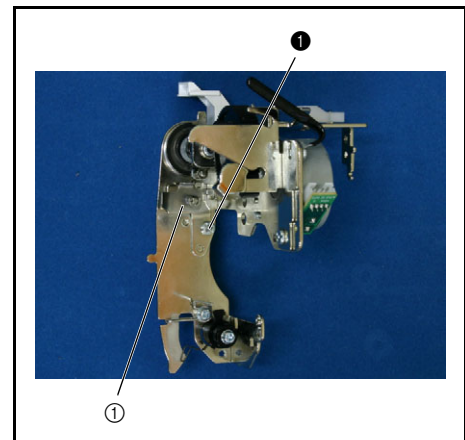
**13** Thread guide shutter removal

1. Remove the retaining ring (E3), and then remove thread guide shutter link B ① and the thread guide shutter ②.

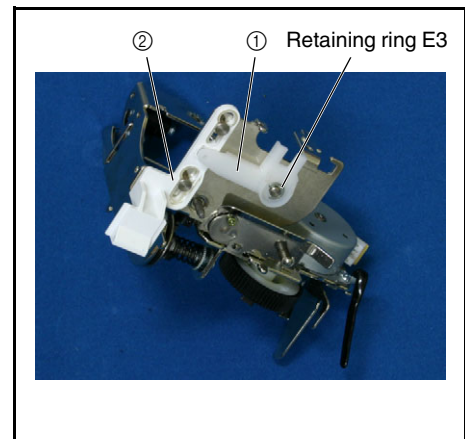
**14** AT pulse motor assembly removal

1. Remove the 2 screws ①, and then remove the AT pulse motor assembly ①.
2. Disconnect the connector of the AT pulse motor lead wire assembly ②.

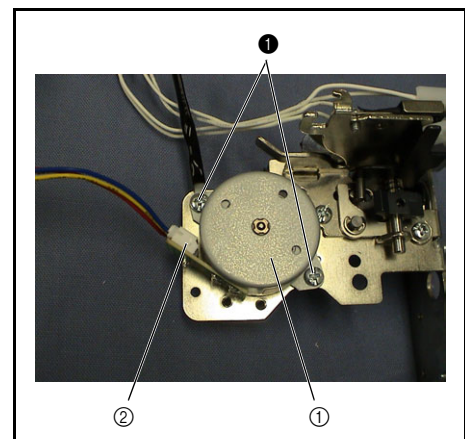



**15** Tension release holder assembly removal

1. Remove the 2 screws ❶, and then remove the tension release holder assembly ❶.

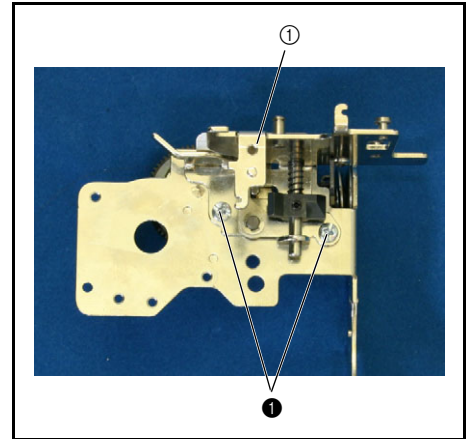
**16** Tension presser plate removal

1. Remove the screw ❶, and then pull out the tension presser assembly ❶.
2. Remove the tension release cam ❷ and the spring S03.

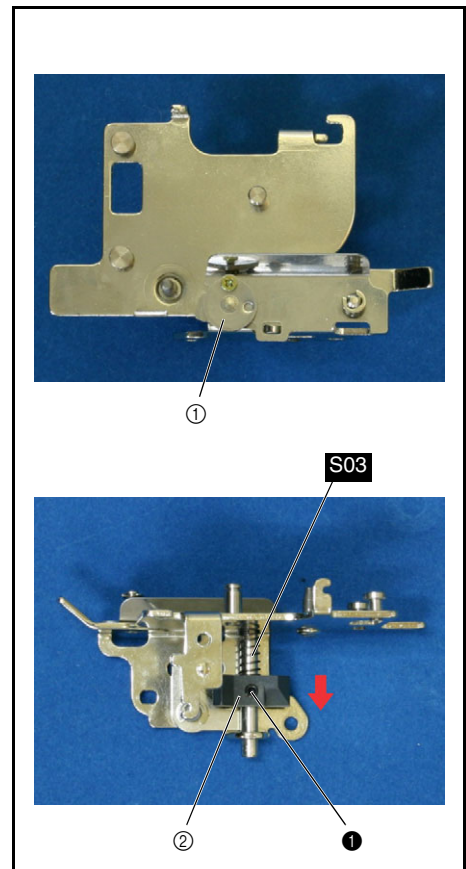

## 17 Tension plate removal

1. Remove the retaining ring (E2), and then remove the spring **S02** and the tension plate ①.
2. Remove the spacer ②.

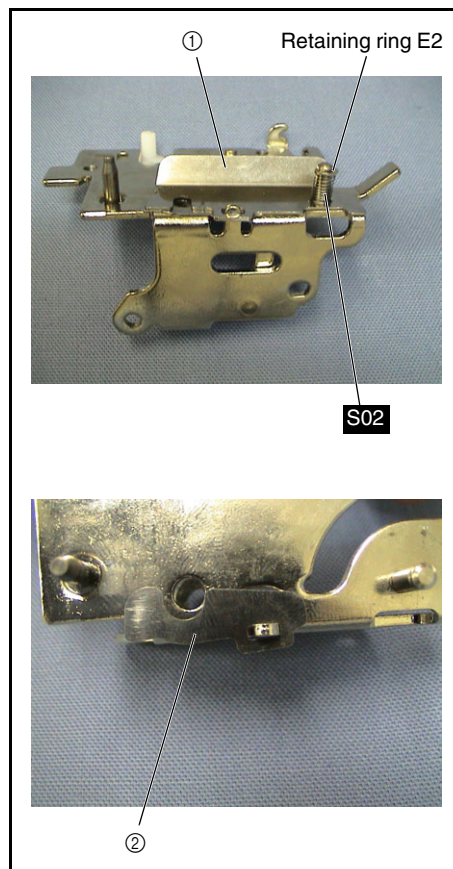

## 18 Thread release link removal

1. Remove the retaining ring (E3), and then remove the thread release link ①.

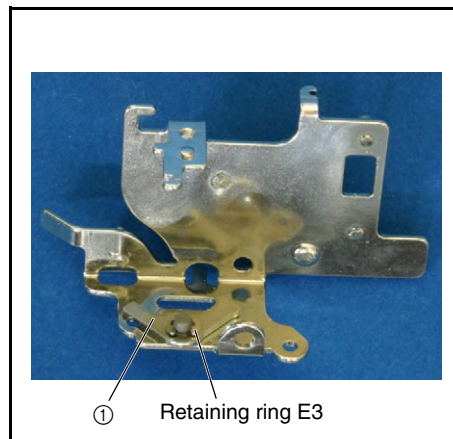



## 19 Thread tension gear assembly removal

1. Remove the retaining ring (E3), and then remove the thread tension gear assembly ①.
2. Loosen the tension adjusting screw ②, and then remove the tension plate assembly ③.
3. Remove the tension adjusting screw ②, spring **S05**, washer ⑤, tension disk washer ⑥, tension release plate assembly ⑦, and washer ⑤ from the thread tension disk shaft ④ of the thread guard.
4. Remove the retaining ring (E2), and then remove the spring **S02** and the plain washer (S3) ⑨ from the calking pin ⑧ of the thread guard.
5. Remove tension disk B ⑩ and tension disk A ⑪ from the tension thread disk shaft ④ of the thread guard.

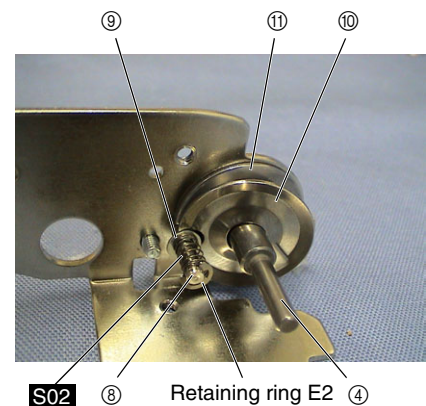
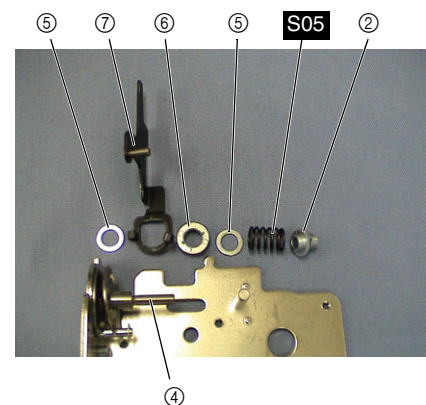
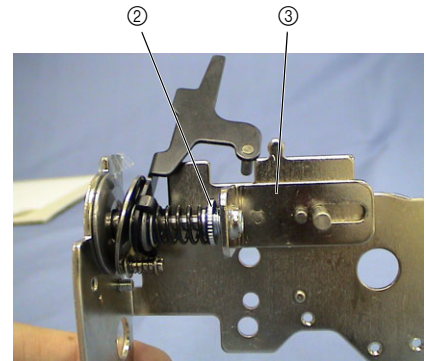
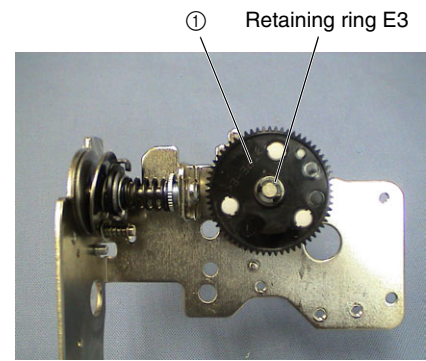

**20** Thread take up spring assembly removal

1. Remove the screw ❶, and then remove the thread take up spring assembly ❶.

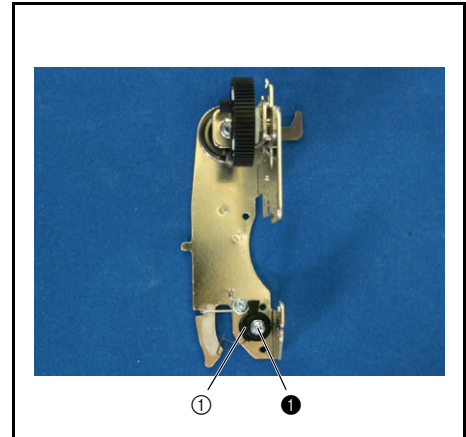
**21** Thread take up spring ASSY disassembly

1. Remove the spring S11.
2. Remove the thread cutting shutter ❶ from the thread catching spring case ❷.

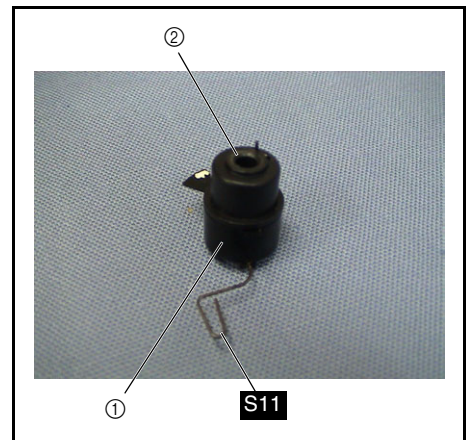
**22** Thread guide wire removal

1. Remove the screw ❶, and then remove the thread guide wire ❶ and the plain washer ❷.

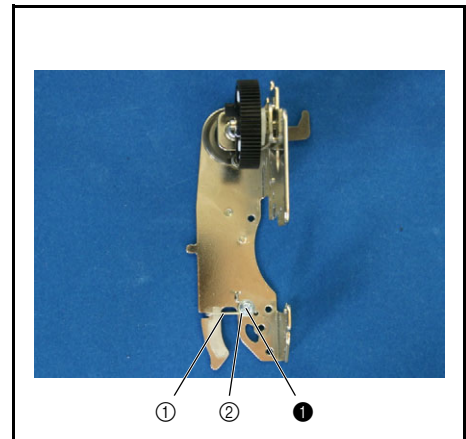
**23** Spring tape removal

1. Remove the spring tape ❶ from the thread guard frame.

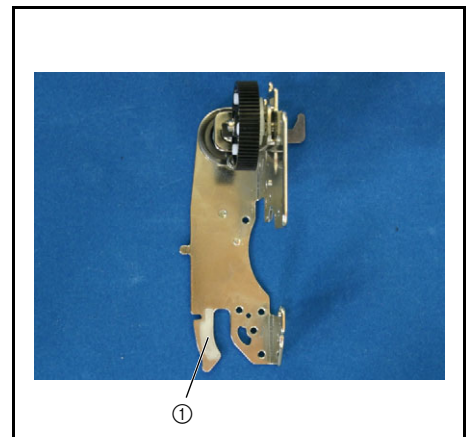

Bobbin winder location diagram

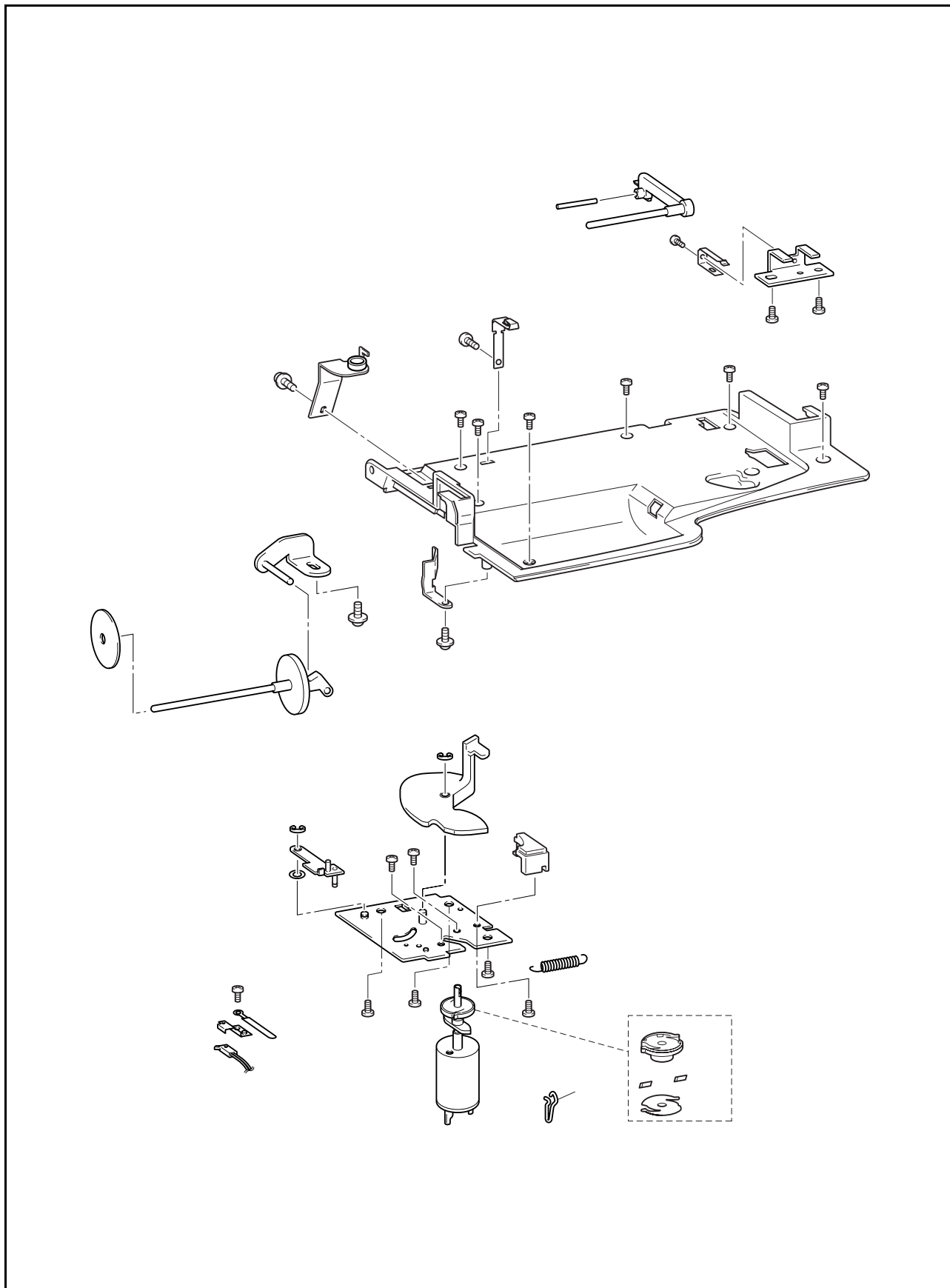

**1 Tension guide assembly removal**

1. Remove the screw ❶, and then remove the tension guide assembly ❶.

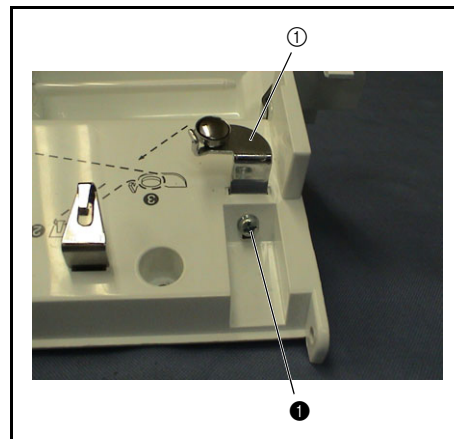
**2 Bobbin base assembly removal**

1. Pull up the bobbin base assembly ❶ to remove it.

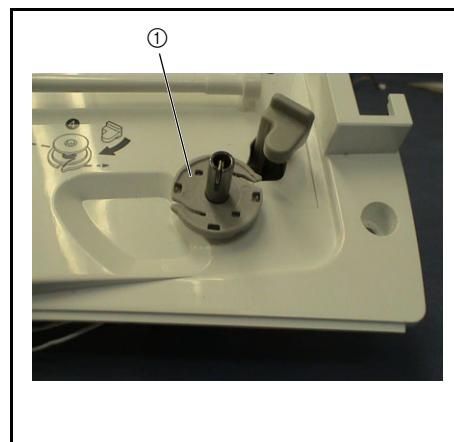
**3 Thread guide plate removal**

1. Remove the screw ❶, and then remove the thread guide plate ❶.

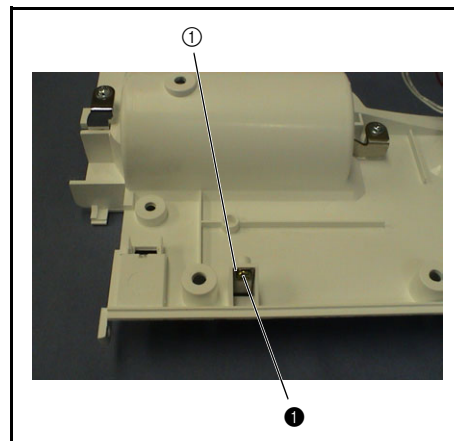
**4 Thread guard plate removal**

1. Remove the screw ❶, and then remove the thread guard plate ❶.

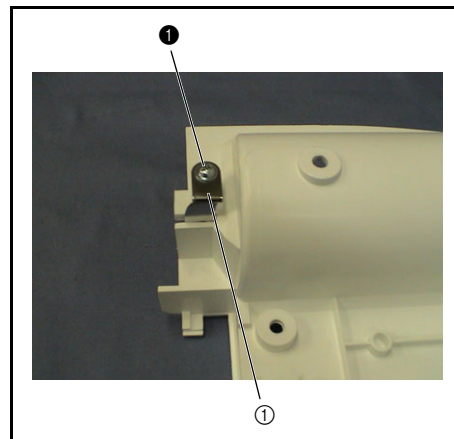

**5** Sub spool stand pin removal

1. Remove the 2 screws ❶, and then remove the sub spool pin holder assembly ❶.
2. Remove the screw ❷, and then remove the spring ❷.
3. Remove the shaft ❸, and then remove the sub spool stand pin ❹.

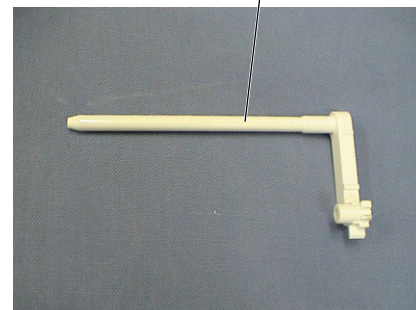
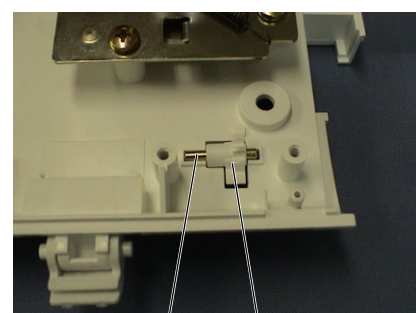
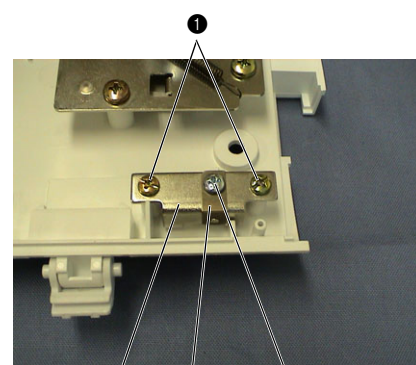

**6** Spool pin removal

1. Remove the screw ❶, and then remove the spool pin holder B assembly ❶.
2. Remove the spool pin ❷.

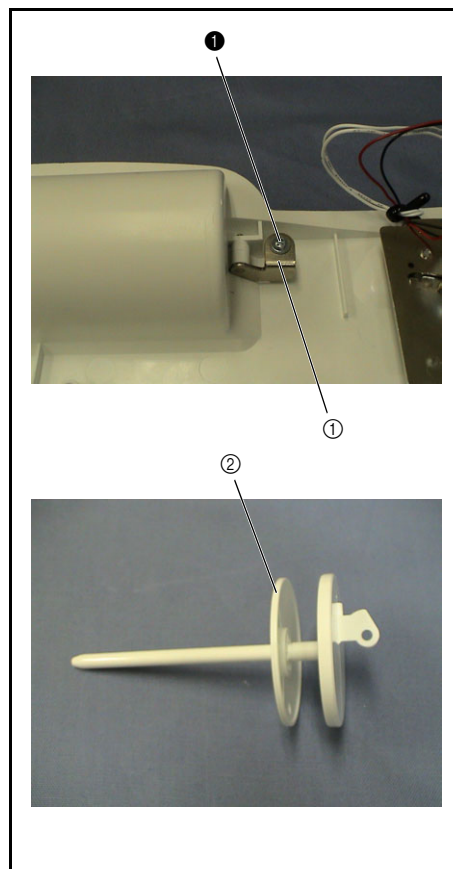
**7** Bobbin winder assembly

1. Cut the band.
2. Remove the 3 screws ❶, and then remove the bobbin winder assembly ❶.

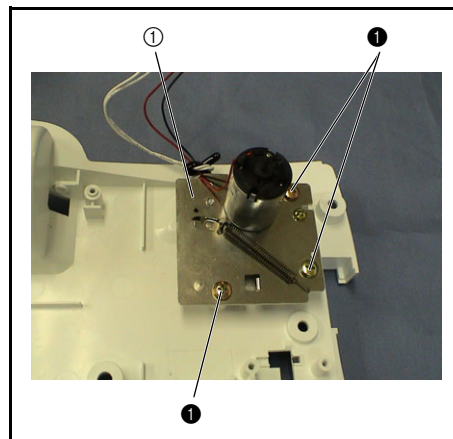



**8** Bobbin presser cover removal

1. Remove the screw ❶. Reverse the bobbin winder assembly ❶, and then remove the bobbin presser cover ❷.

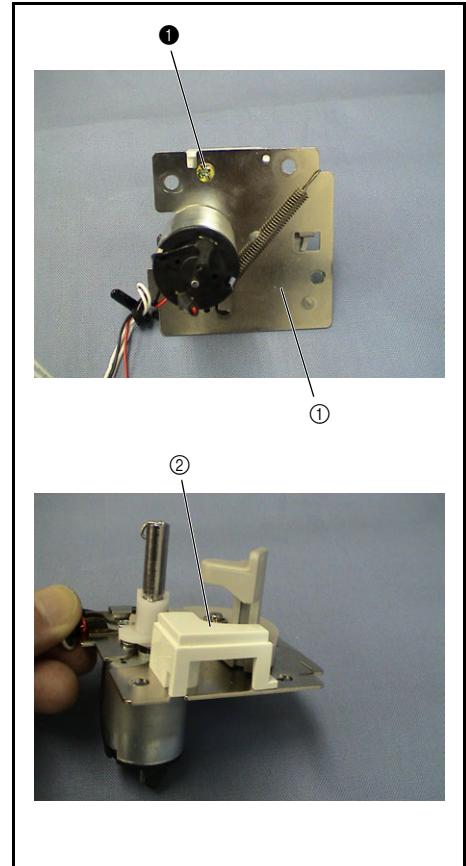
**9** BWSW assembly (D6) removal

1. Remove the screw ❶, and then remove the BWSW assembly (D6) ❶.
2. Remove the BWSW assembly ❷ from the BW switch holder ❸.

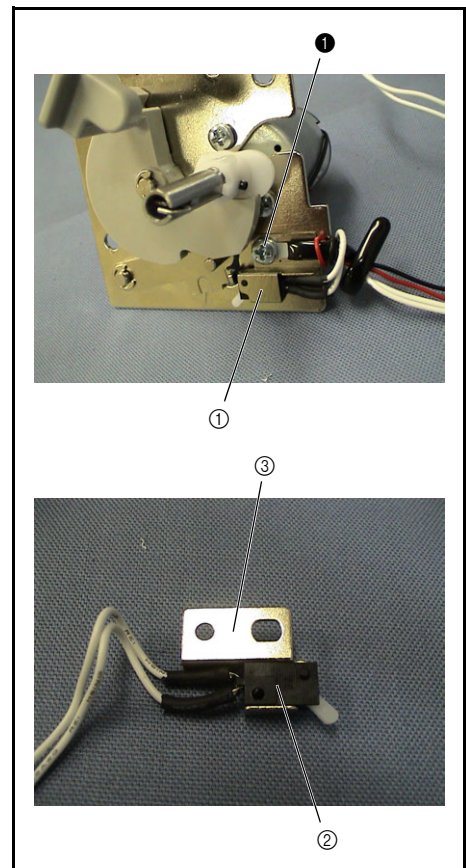

**10 Spring removal**

1. Remove the spring **S59**.

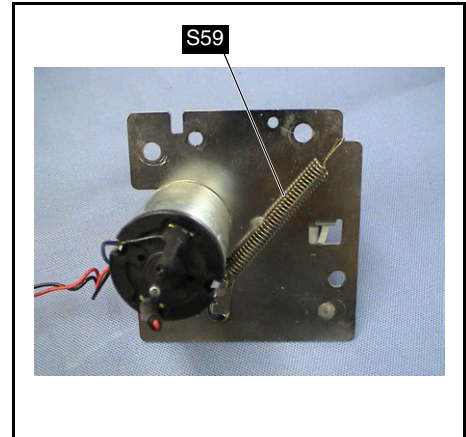
**11 Bobbin presser guide assembly removal**

1. Remove the retaining ring (E3), and then remove the bobbin presser guide assembly ① and the polyester slider ②.

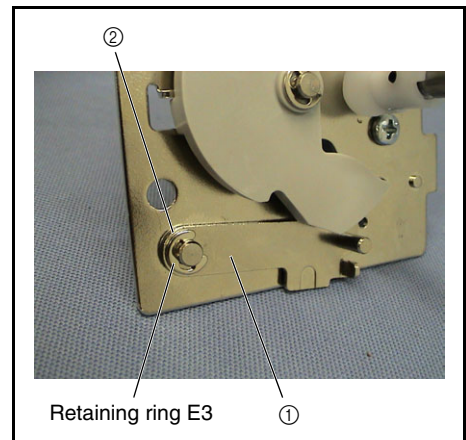
**12 Bobbin presser removal**

1. Remove the retaining ring (E3), and then remove the bobbin presser ①.

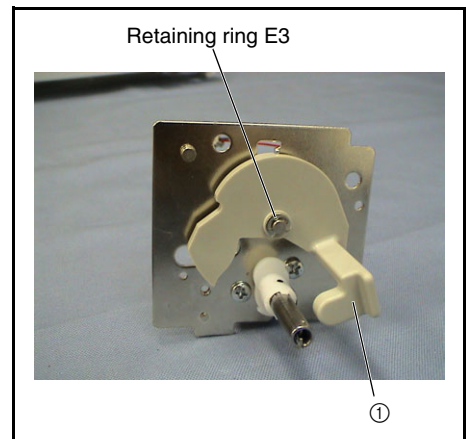
**13 BW motor assembly removal**

1. Remove the 2 screws ①, and then remove the BW motor assembly ①.

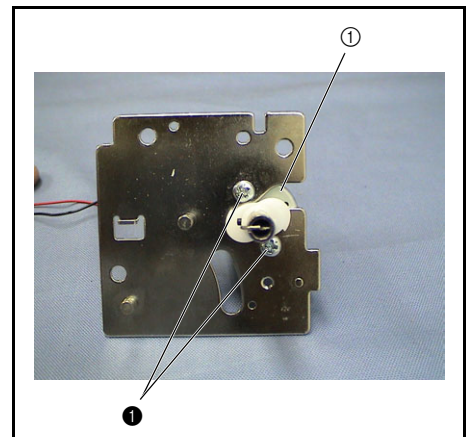



Rotary hook driving unit, feed/rotary hook unit, thread cutter unit, side feed unit location diagram

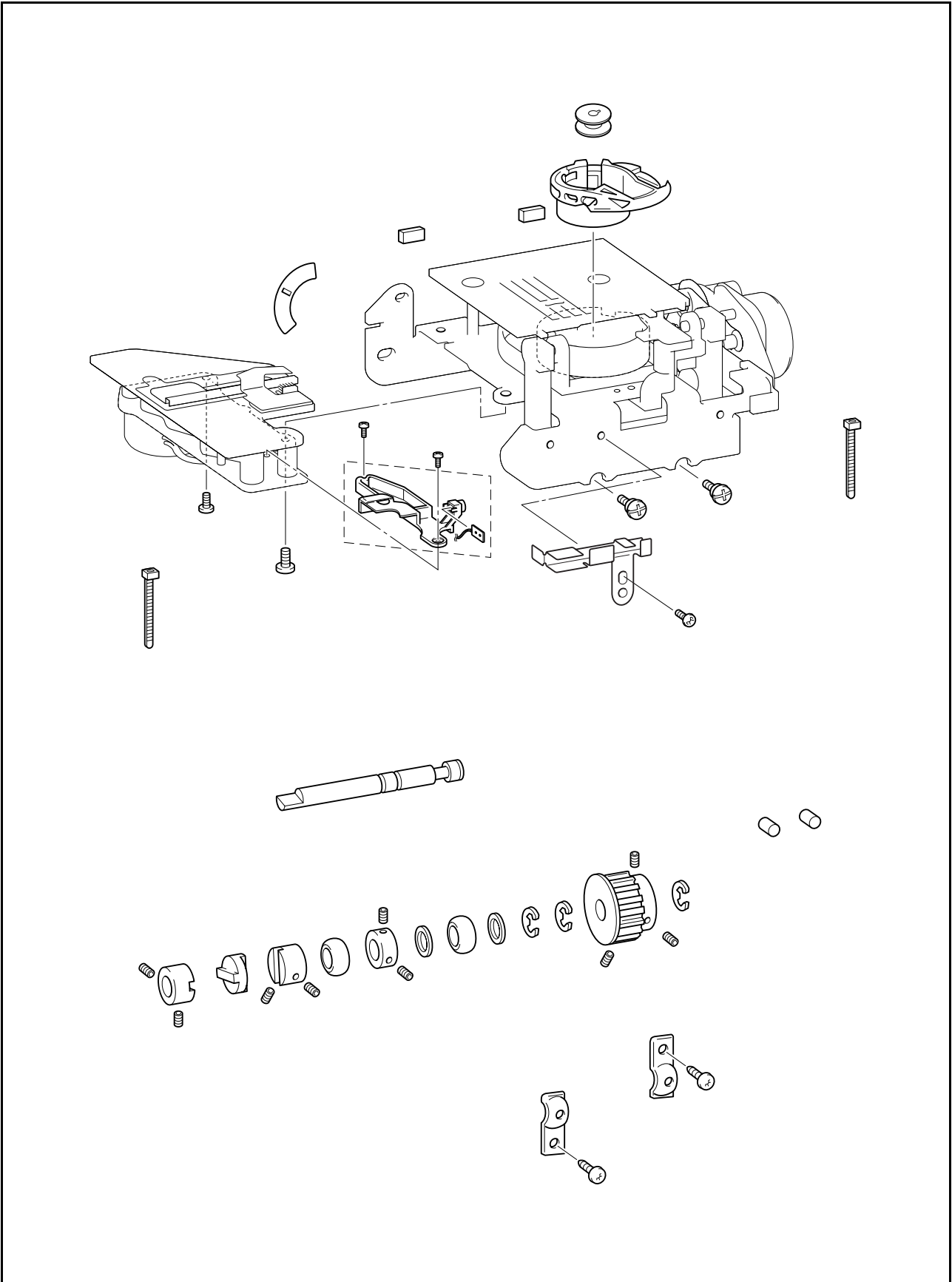

Disassembly

### 1 Lead wire guide holder removal

1. Remove the screw ❶, and then remove the lead wire guide holder ❶.

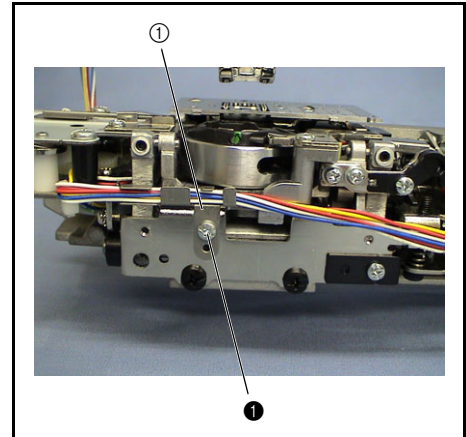

### 2 Side feed module removal

1. Remove the 2 screws ❶.
2. Remove the 2 screws ❷, and then remove the side feed module ❶.

**\*Key point**

- Refer to "Side feed module" on page 2 - 78 for the disassembly procedure.

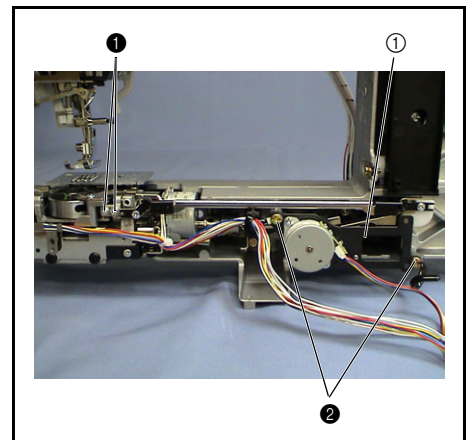

### 3 Thread cutter module removal

1. Remove the screws (❶ and ❷) on the bottom of the thread cutter module ❶, and then remove the thread cutter module ❶ from the feed/rotary hook module.

**\*Key point**

- Refer to "Thread cutter module" on page 2 - 81 for the disassembly procedure.

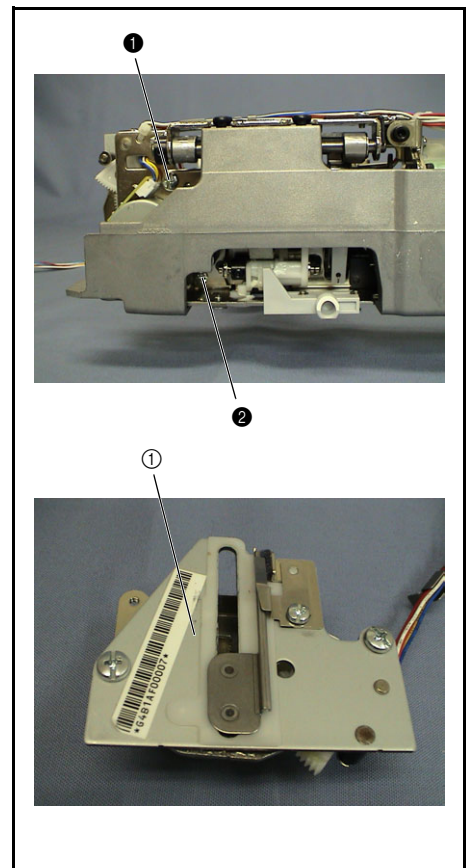

#### 4 Feed/rotary hook module removal

1. Rotate the pulley (upper shaft) until the base line of the pulley comes to the top (needle bar is at the top point).
2. Remove the 2 screws ❶, and then remove the feed/rotary hook module ❶.
3. Remove the disk ❷ from the lower shaft.

**\*Key point**

- Refer to "Feed/rotary hook module" on page 2 - 64 for the disassembly procedure.

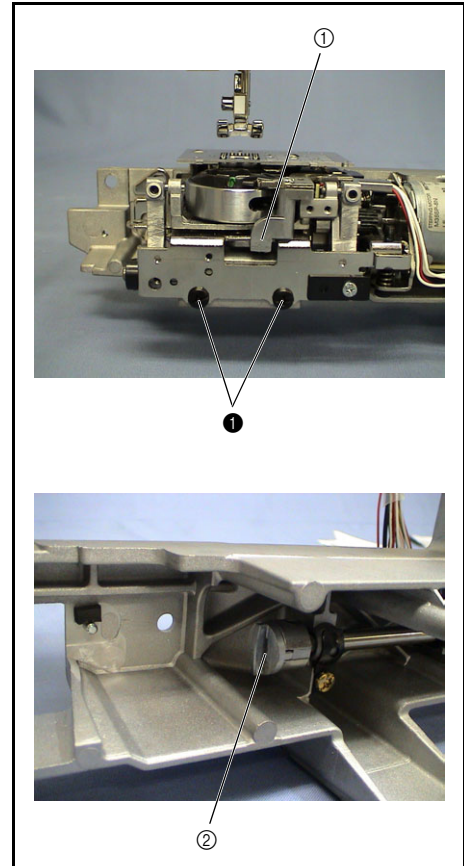

#### 5 Sheet removal

1. Remove the sheet ❶ (2 locations).

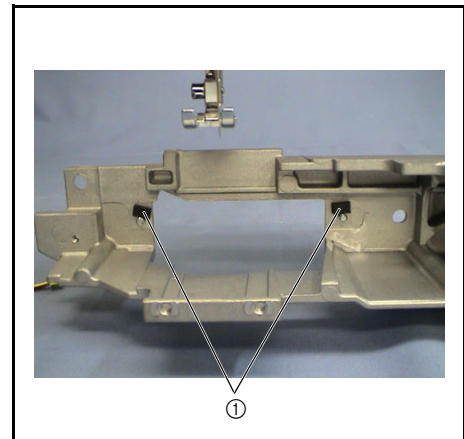

#### 6 Lower shaft A assembly removal

1. Remove the 2 screws ❶, and then remove the bushing pressers ❶ (2 locations).
2. Remove the lower shaft A assembly ❷ from the timing belt ❸.

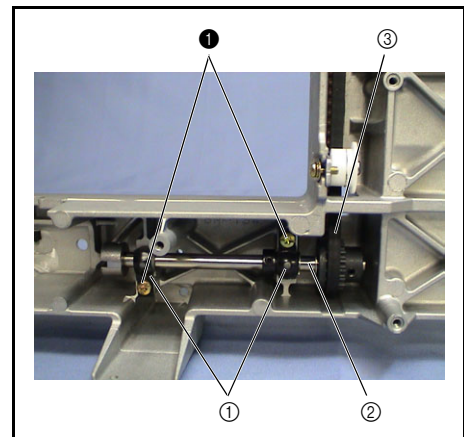

Needle-presser unit, needle threader unit, upper shaft unit location diagram

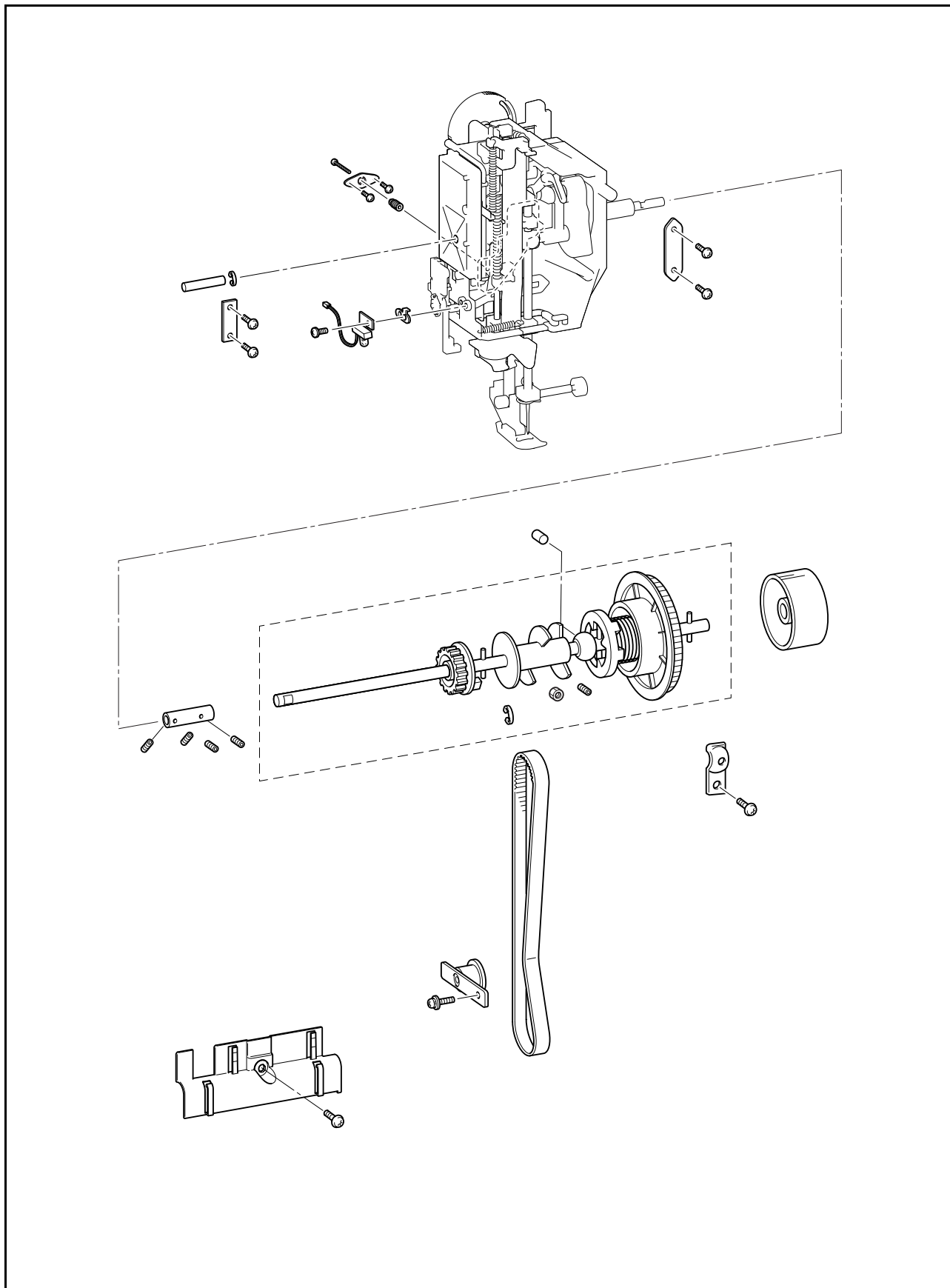

**1** Upper shaft cover removal

1. Remove the screw ❶, and then remove the upper shaft cover ①.

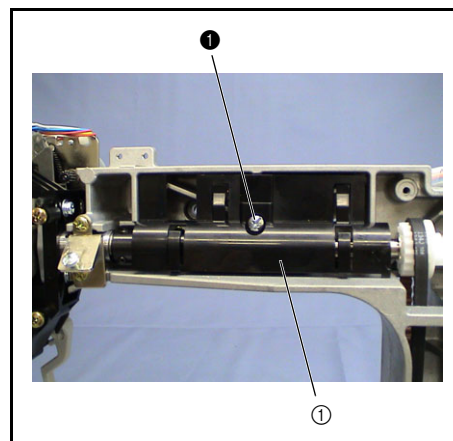
**2** Tension pulley assembly removal

1. Remove the screw ❶, and then remove the tension pulley assembly ①.

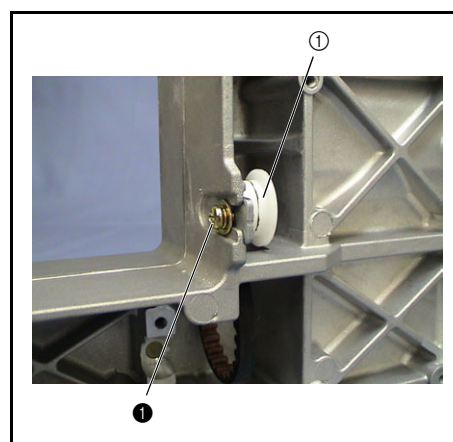

### 3 Upper shaft assembly removal

1. Remove the 2 screws ①. Rotate the upper shaft half a turn and remove the 2 screws ②.
2. Remove the screw ③, and then remove the bushing presser ①.
3. Move the fixed joint ② to the right, and then remove the upper shaft assembly ③.
4. Remove the timing belt ④, and then pull the fixed joint ② to the left to remove it.

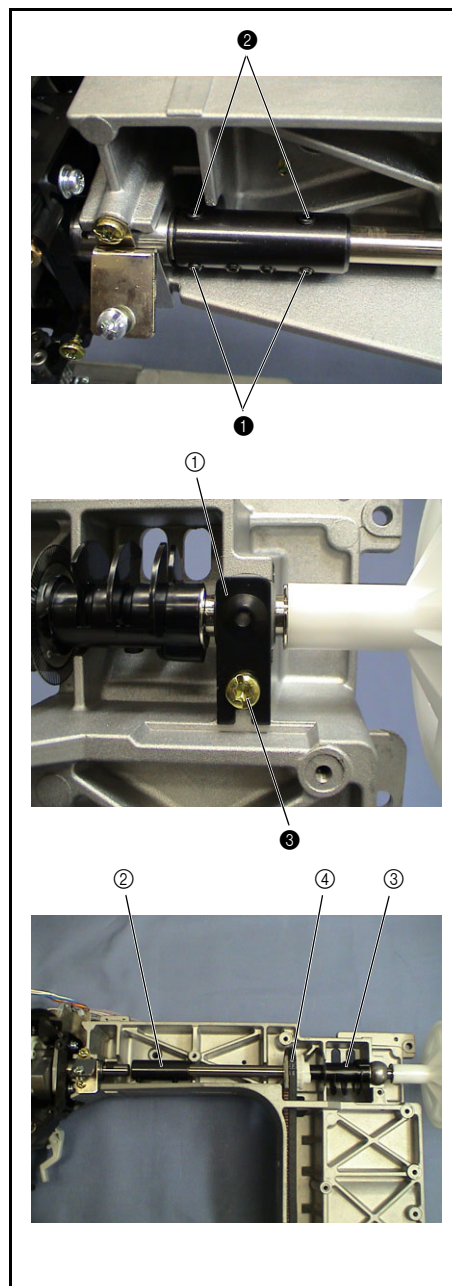



#### 4 Needle-presser module removal

1. Remove the screw ❶ on the rear of the module.
2. Remove the 2 screws ❷, and then remove the presser plate B ❶, adjust plate A ❷.
3. Remove the 2 screws ❸, and then remove the presser plate A ❸.
4. Remove the needle-presser module ❹.
5. Remove the shaft ❺ from the needle-presser module ❹.

**\*Key point**

- Refer to "Needle-presser module" on page 2 - 46 for the disassembly procedure.

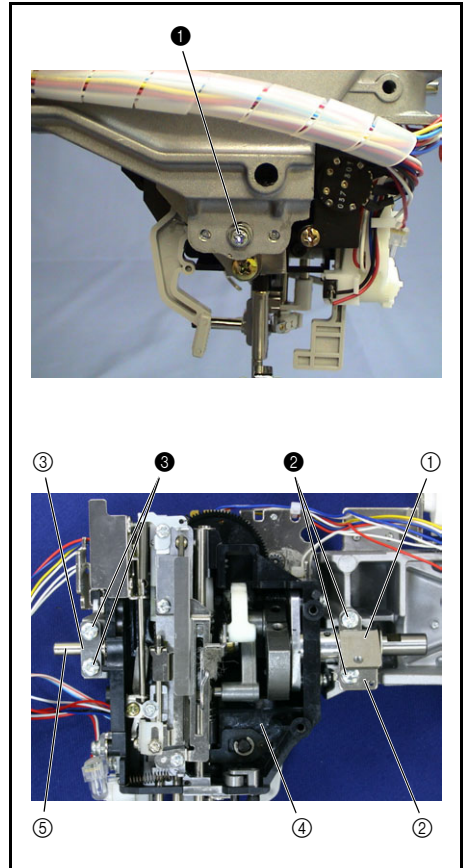

#### 5 Plate spring removal

1. Remove the 2 screws ❶, and then remove the plate spring ❶.

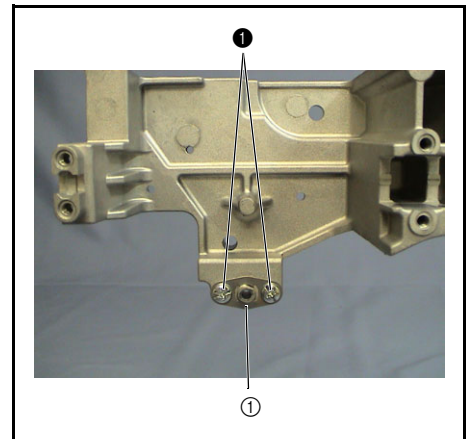

### Needle-presser module location diagram

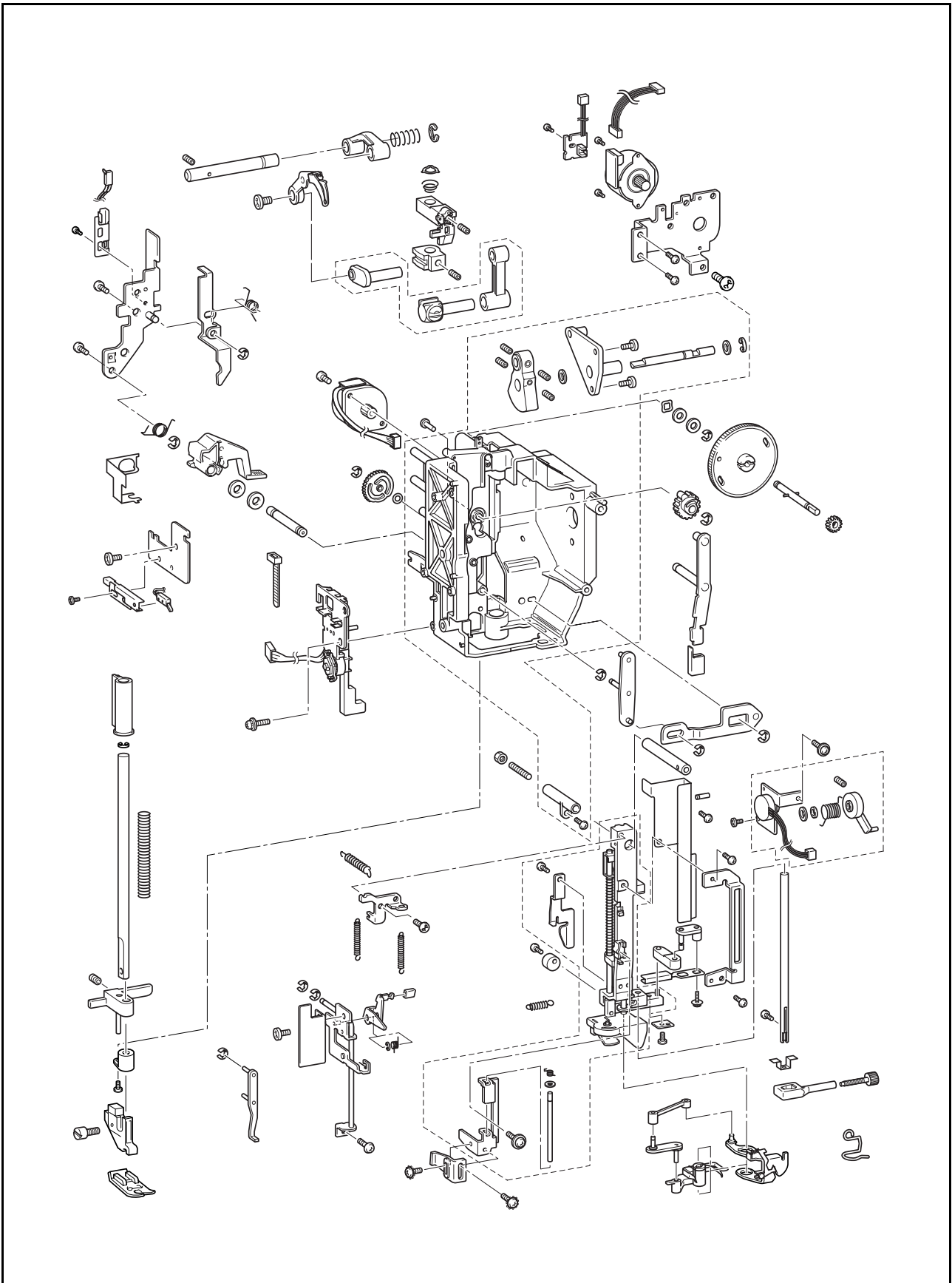



### 1 Presser feed holder assembly removal

1. Press the black button on the rear of the presser feed holder assembly ① to remove the presser foot ②.
2. Loosen the screw ①, and then pull out the presser feed holder assembly ①.

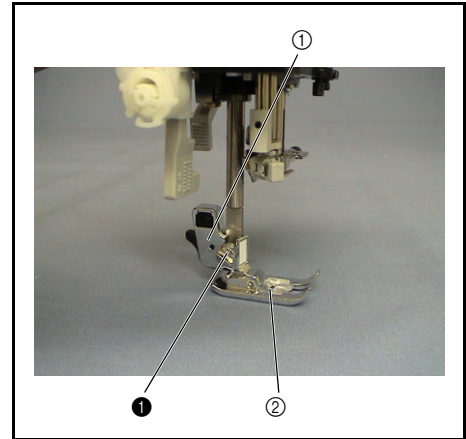

### 2 Threader hook ASSY disassembly

1. Remove the thread guide assembly, threader hook assembly, link A assembly, and link B.

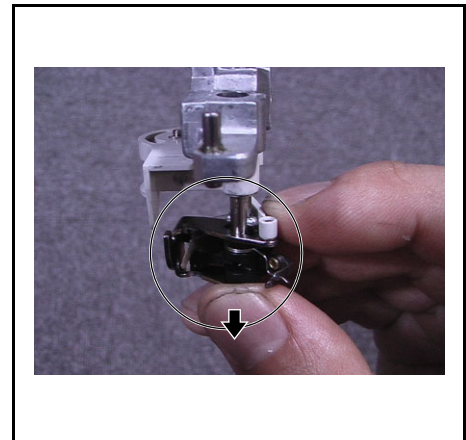

### 3 Presser pulse motor holder assembly removal

1. Remove the 3 screws ①②, and then remove the presser pulse motor holder assembly ①.

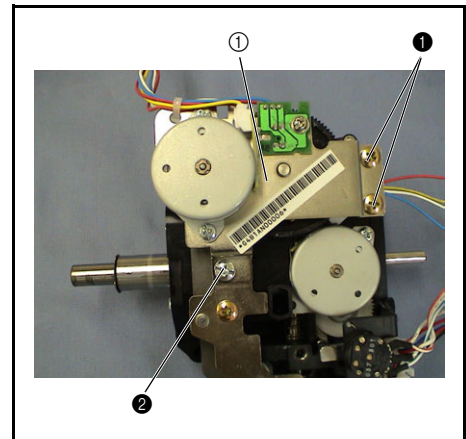

### 4 Presser pulse motor holder ASSY disassembly

1. Remove the screw ①, and then remove the ATPF INIT PCB assembly ①.
2. Remove the 2 screws ②, and then remove the presser pulse motor ②.
3. Remove the presser pulse motor lead wire assembly ③ from the presser pulse motor ②.

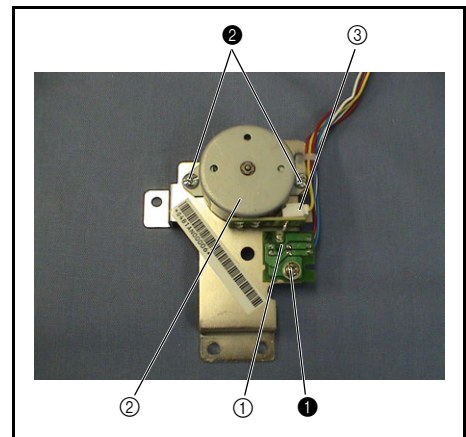

### 5 Presser dial removal

1. Remove the spring washer ①, 2 plain washers ②, and retaining ring (E4), and then remove the presser dial ③.

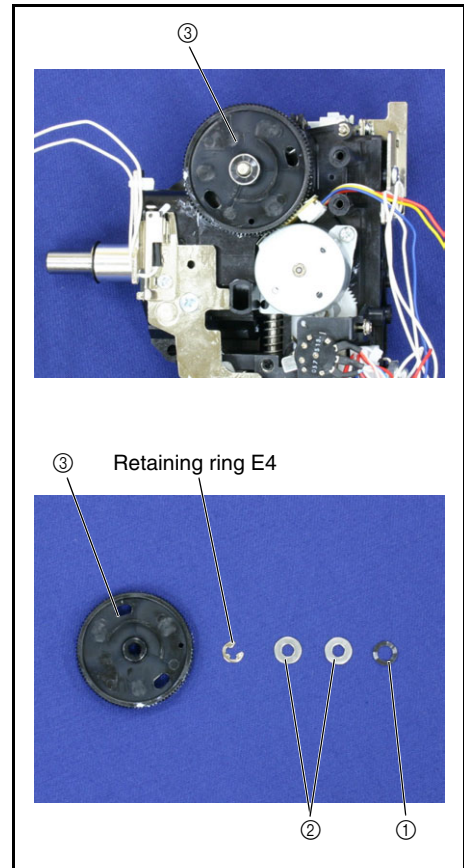

### 6 BHSW D6 switch assembly and LED PCB D6 assembly removal

1. Remove the screw ①, and then remove the BHSW D6 switch assembly ①.
2. Remove the screw ②, and then remove the LED PCB D6 assembly ② and the lamp holder ③.

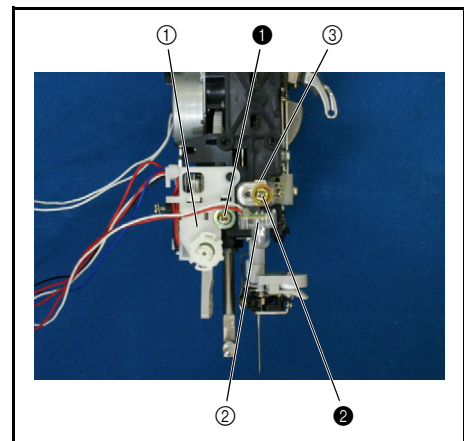

### 7 PT holder assembly removal

1. Remove the screws ①, ②, and then remove the PT holder assembly ①.

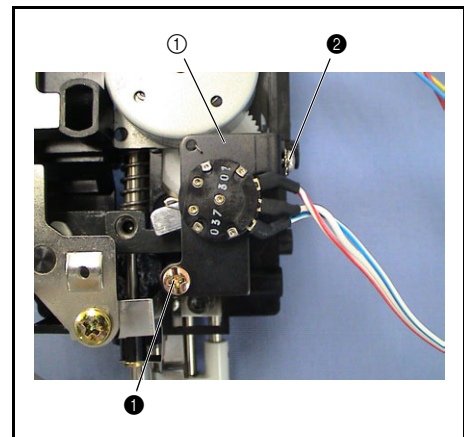

**8** PT holder ASSY disassembly

1. Remove the screw ❶, and then remove the PT lever ❶ and spring ❷.
2. Remove the nut ❸, and then remove the plain washer (M6) ❹.
3. Remove the cloth thickness sensor assembly ❺ from the PT holder ❻.

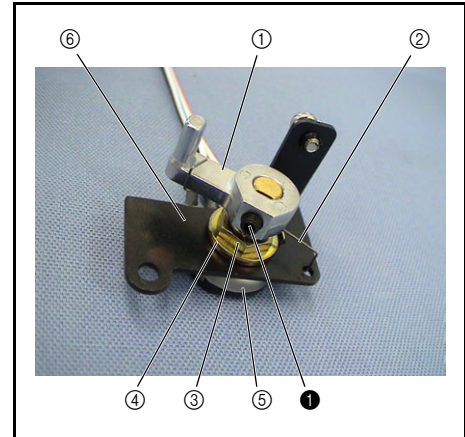
**9** Lock nut removal

1. Remove the screw ❶ with the lock nut ❶ attached.
2. Remove the lock nut ❶ from the screw ❶.

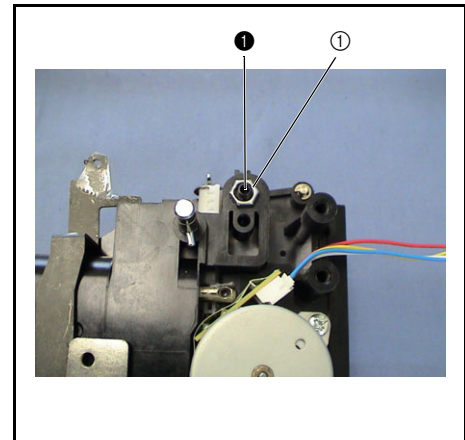
**10** Zigzag adjusting nut removal

1. Remove the screw ❶, and then remove the zigzag adjusting nut ❶.

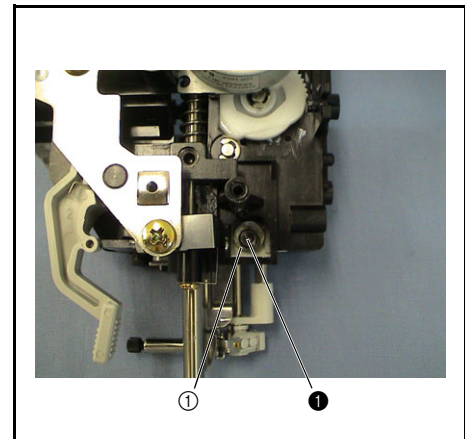
**11** Spring removal

1. Remove the spring S10.

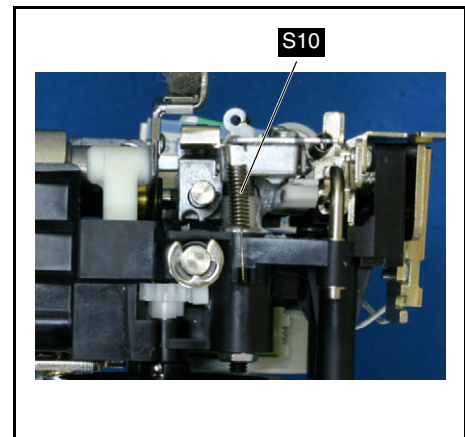

## 12 Spring-Z removal

1. Remove the spring **S20**.

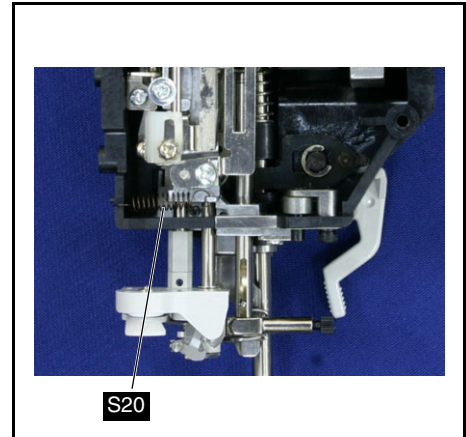

## 13 Needle holder shaft block removal

1. Remove the screw **1** at the lower section of the unit holder, and then remove the needle holder shaft block **1**, needle holder block **2**, and thread guide plate **3**.

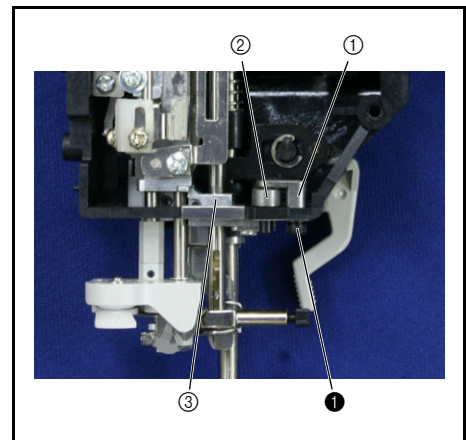

## 14 Spring removal

1. Remove the spring **S62**.

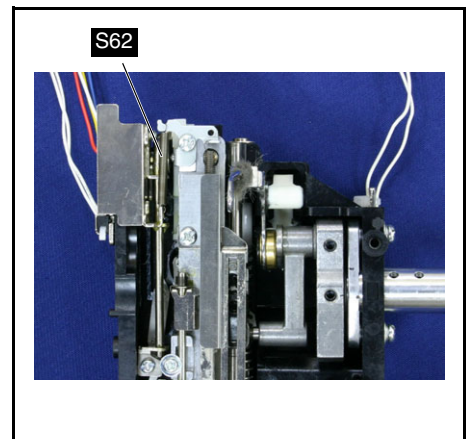

## 15 Spring removal

1. Remove the screw **1**, and then remove the guard plate **1**.
2. Remove the spring **S42**.

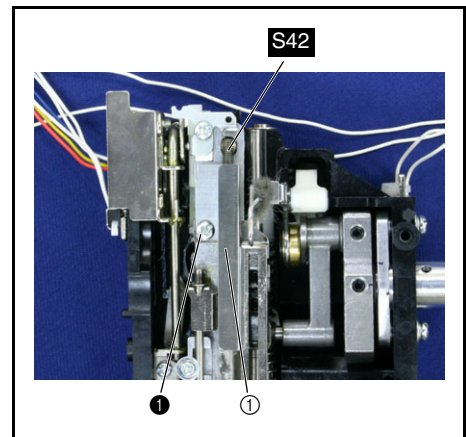



**16** Needle holder assembly removal

1. Remove the screw ①, and then remove the plate ①.
2. Remove the screw ②, and then press the left end of the shaft ② to remove the shaft from the right end.
3. Pull out the shaft ③.
4. Remove the needle bar block shaft ④ from the crank rod ⑤.
5. Remove the needle holder assembly ⑥ from the unit holder.

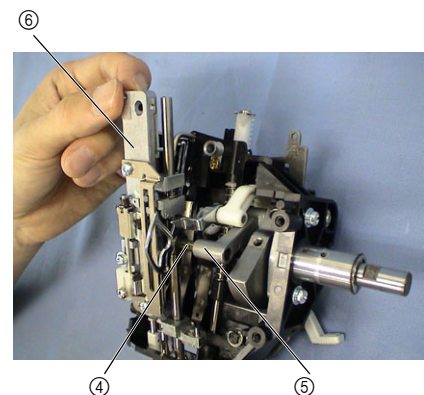
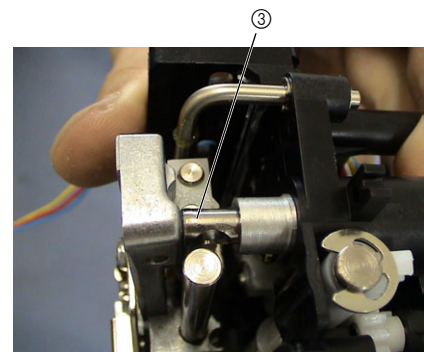
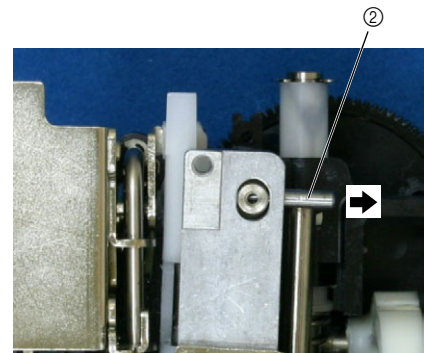
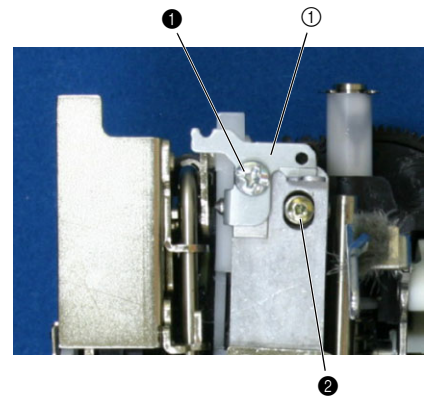

**17** Hook release plate removal

1. Remove the screw ❶ on the rear of the needle holder assembly, and then remove the hook release plate ①.

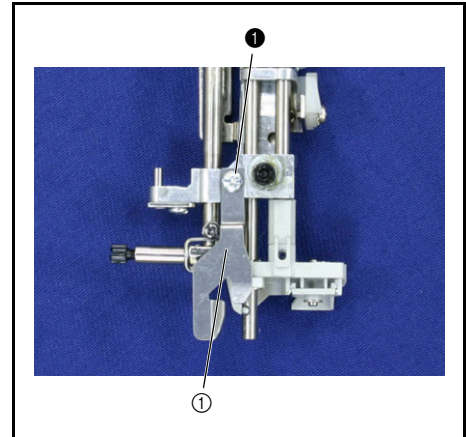
**18** Release adjuster removal

1. Remove the 2 screws ❶, and then remove the release adjuster ①.

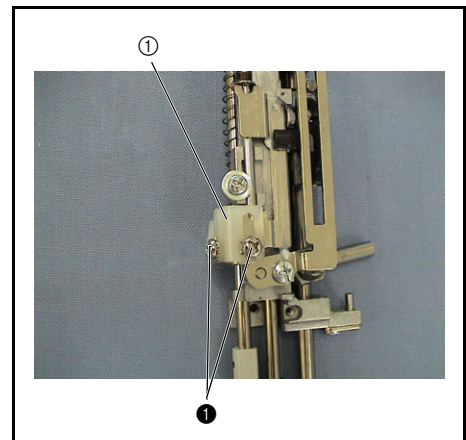
**19** Release guide plate removal

1. Remove the screws ❶, and then remove the release guide plate ①.

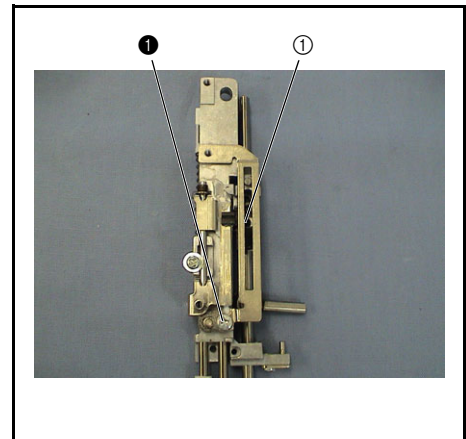
**20** Release lever spring removal

1. Remove the spring S40.

**\*Key point**

- Release the straight section of the spring S40 from the groove on the needle holder assembly ①.
- Disengage the hook of the spring S40 from the release lever ②.

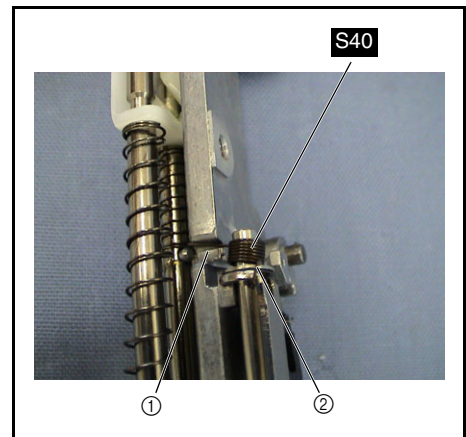

### 21 Release lever assembly removal

1. Remove the screw ❶, and then remove the release lever assembly ❶.

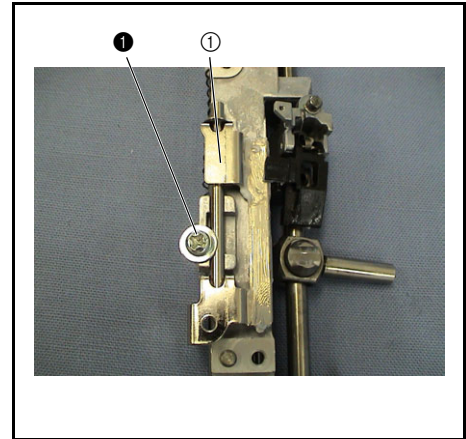

### 22 Release lever ASSY disassembly

1. Remove the release lever ❷ from the release lever shaft ❶.
2. Remove the thrust wafer ❸ and the retaining ring (E2.5) from the release lever shaft ❶.

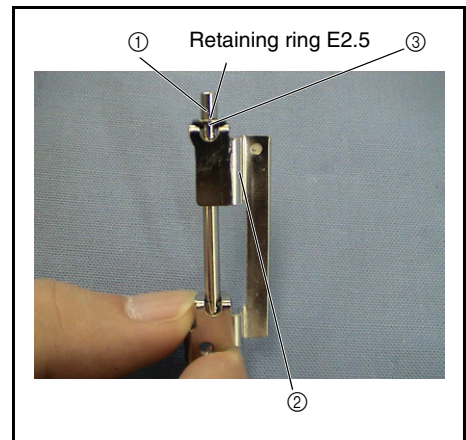

### 23 Needle holder ASSY disassembly

1. Remove the screw ❶ from the needle holder block ❶ and the screw ❷ from the needle bar hook stand assembly ❷.
2. Pull the needle bar assembly ❸ downward, and then remove the needle bar block ❹, needle holder block ❶, needle bar hook stand assembly ❷, spring S43, and thrust washer ❺.

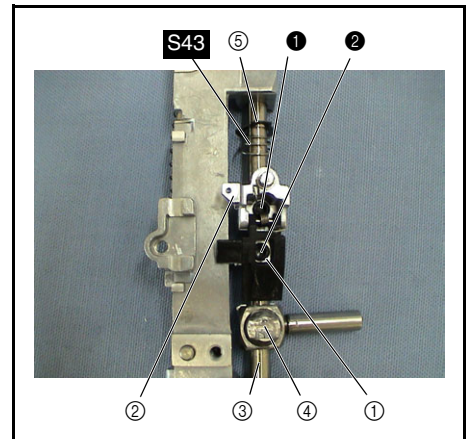

### 24 Needle bar ASSY disassembly

1. Remove the screw ❶, and then remove the needle bar thread guide ❶.
2. Remove the screw ❷, and then remove the needle block ❷.
3. Remove the needle thread plate ❸ from the needle block ❷.

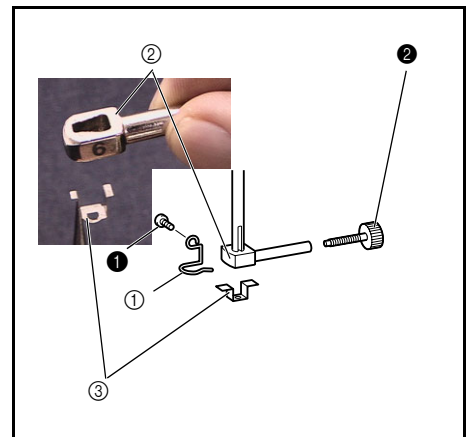

**25** Thread lever switch unit removal

1. Remove the screw ❶, and then remove the thread lever switch unit ❶.
2. Remove the screw ❷, and then remove the presser switch holder ❷ and the thread lever switch assembly ❸.

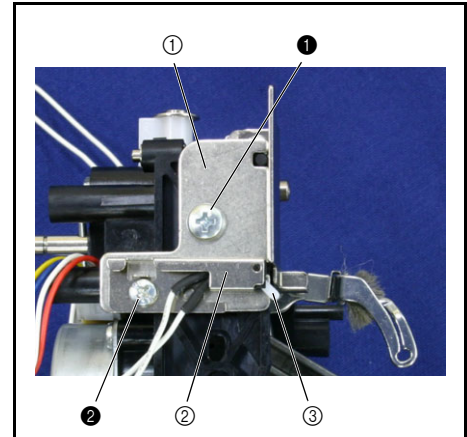
**26** Lever AB unit removal

1. Remove the retaining ring (E2) on the rear of the unit holder from the lever guide shaft ❶.
2. Remove the screw ❶, and then remove the lever supporter plate ❷.
3. Pull out the lever guide shaft ❶ from the unit holder.
4. Remove the lever AB unit ❸ from the lever guide shaft ❶.
5. Remove the retaining ring (E2) from the lever guide shaft ❶.

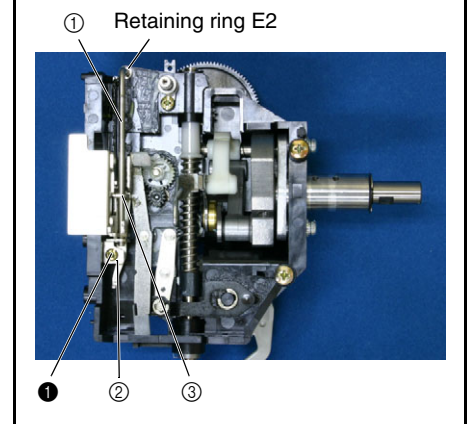
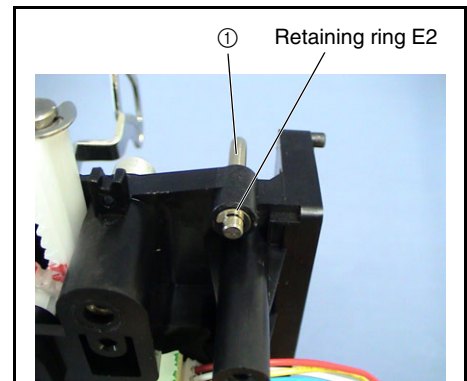
**27** Lever AB unit disassembly

1. Remove the screw ❶, and then remove the needle threader driving plate ❶.

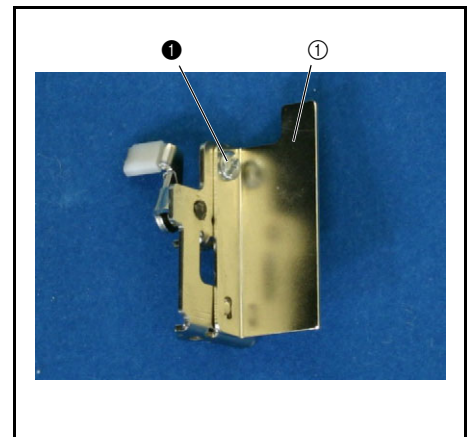



**28** Lever AB ASSY disassembly

1. Remove the retaining ring (E3), and then remove the lever B ② and the spring S08 from the lever A assembly ①.
2. Remove the cap ③ from the lever B ②.

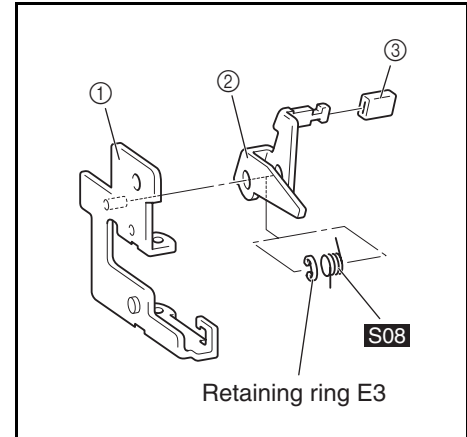
**29** Shaft bushing A removal

1. Remove the screw ①, and then remove the shaft bushing A ① from the unit holder.

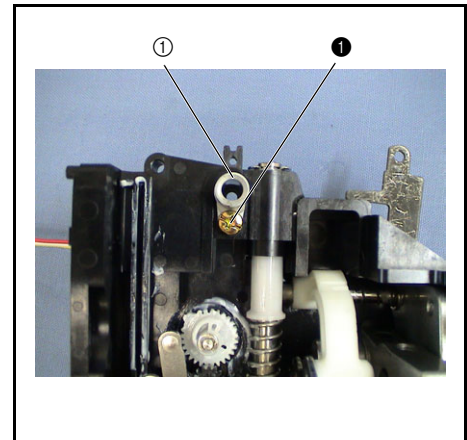
**30** Adjust plate removal

1. Remove the screw ①, and then remove the adjust plate ①.

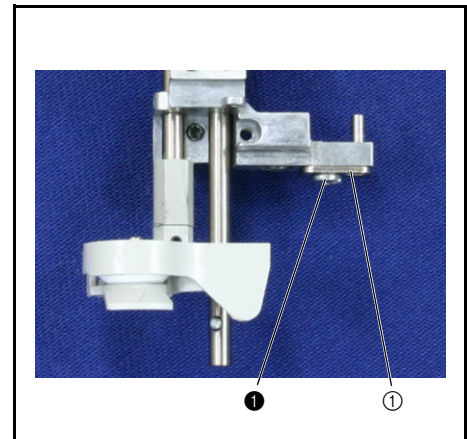

**31** Adjusting plate assembly removal

1. Remove the 2 screws ①, and then remove the adjusting plate assembly ①.
2. Remove the spring S58.

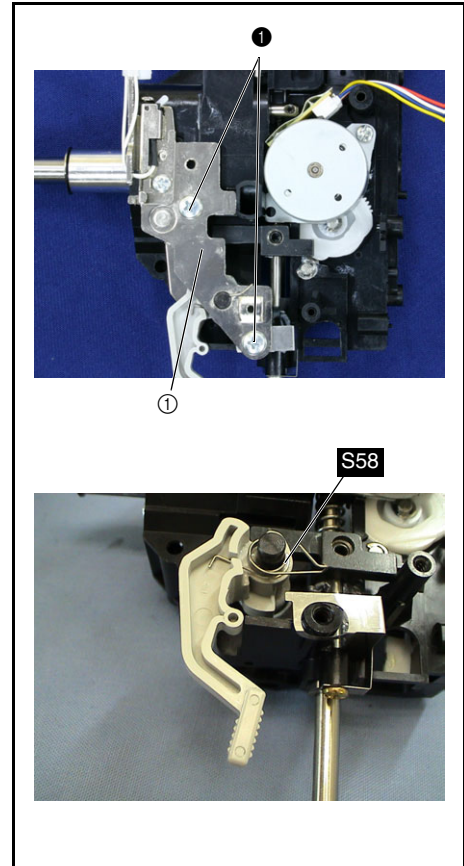
**32** Adjusting plate ASSY disassembly

1. Remove the retaining ring (E3), and then remove the switch lever ① and spring S68.
2. Remove the screw ①, and then remove the presser switch assembly ②.

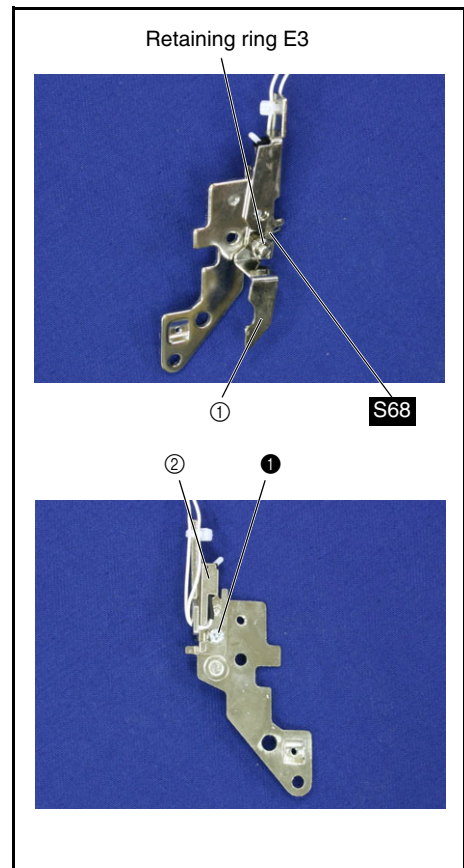

**33** Release plate assembly removal

1. Remove the retaining ring (E2), and then remove the release plate assembly ①.

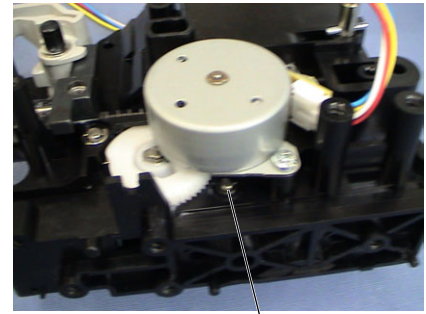

Retaining ring E2

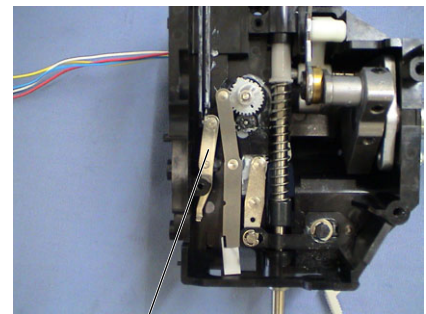

①

**34** Press foot lifter removal

1. Remove the retaining ring (E4), and then remove the presser foot lifter ① and 2 washers ②.
2. Pull out the presser lift shaft ③ from the rear of the presser module, and then remove the retaining ring (E4).

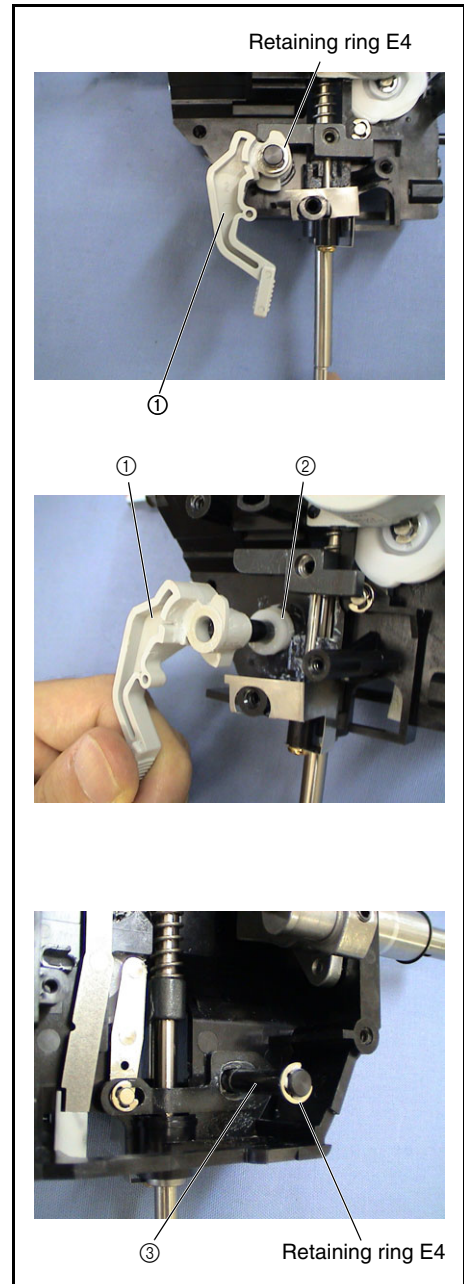
**35** Tension release rod removal

1. Remove the retaining ring (E3), and then remove the tension release rod ①.

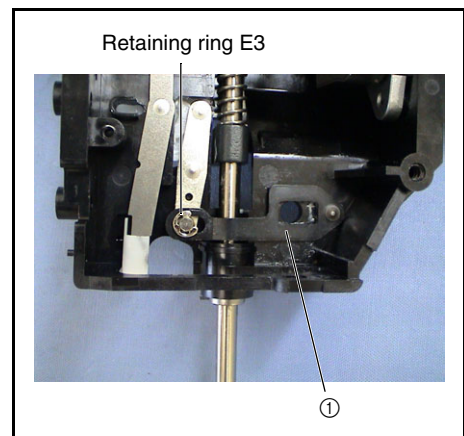

**36** Thread take-up lever assembly removal

1. Remove the screw ❶, and then remove the thread take-up lever assembly ❶.

**\*Key point**

- The screw ❶ has a reverse helical flute thread.

2. Remove the 2 screws ❷, and then remove the needle bar crank ❷ and the needle bar crank rod ❸.

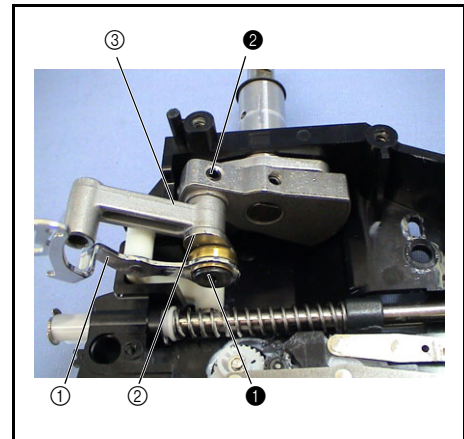
**37** Thread take-up counter weight removal

1. Remove the 2 screws ❶.

**\*Key point**

- Remove the 2 face-to-face screws ❶ tightened at the center of the thread take-up counter weight ❷.

2. Remove the thread take-up counter weight ❷ and the thrust wafer ❸ from the unit shaft ❶.
3. Pull out the unit shaft ❶ in the direction of the arrow, and then remove the thrust wafer ❷ and the retaining ring (E8).

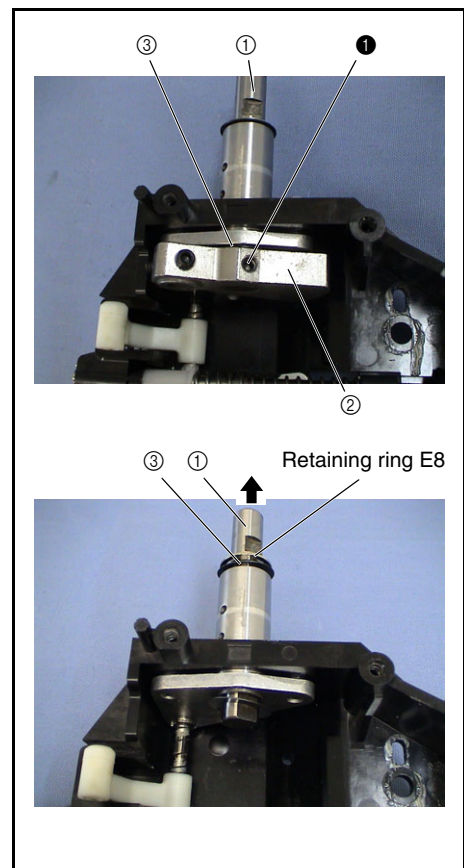



**38** Z zigzag lever assembly removal

1. Remove the retaining ring (E3) on the rear of the Z zigzag lever assembly ①, and then remove the zigzag lever assembly ①.
2. Remove the Z lever cap ② from the Z zigzag lever ①.

**\*Key point**

- Remove the retaining ring (E3) attached to the T cam ③.

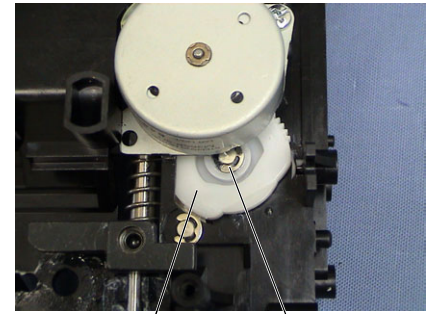

③ Retaining ring E3

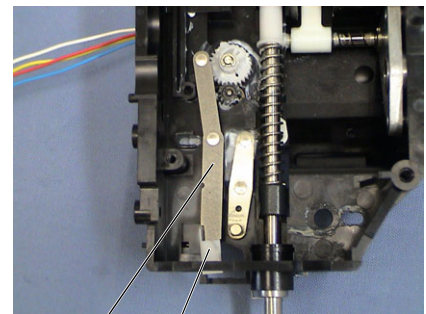

① ②

**39** Thread release lever assembly removal

1. Remove the retaining ring (E3) on the rear of the thread release lever assembly ①, and then remove the thread release lever assembly ①.

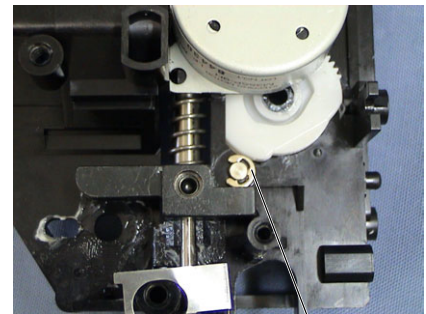

Retaining ring E3

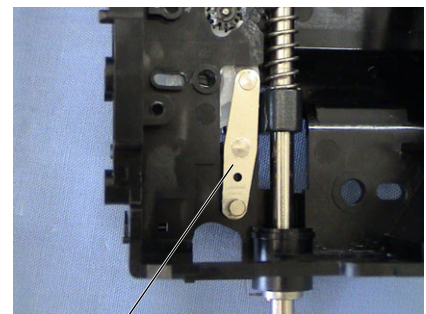

①

**40 Z zigzag cam removal**

1. Remove the retaining ring (E2), and then remove the Z zigzag cam ①.

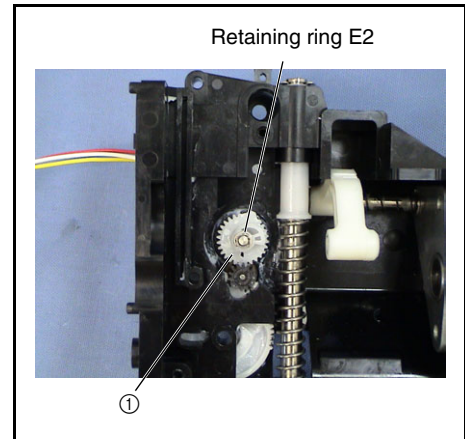
**41 Z pulse motor assembly removal**

1. Remove the screw ①, and then remove the Z pulse motor assembly ①.

**\*Key point**

- Rotate pulse motor Z counterclockwise to remove it.
2. Peel the insulation tape from the PCB of the Z pulse motor assembly.

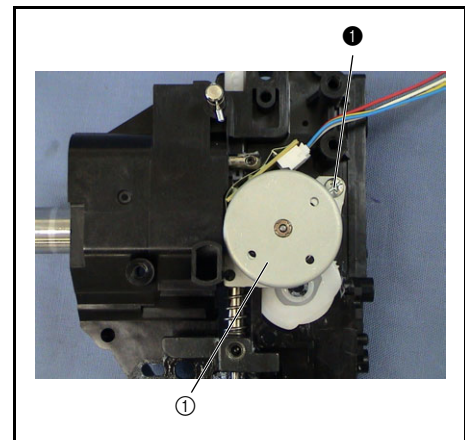
**42 Shaft removal**

1. Press the top of the shaft ①, and remove it from the bottom.

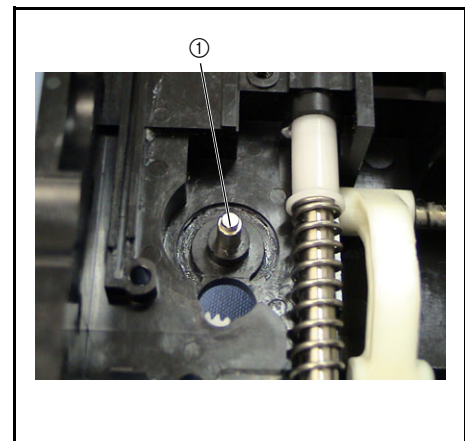
**43 T cam removal**

1. Rotate the T cam ① until the gear tooth is on the right, and then lift the gear tooth to remove the T cam ① from the unit holder.
2. Remove the polyester slider ②.

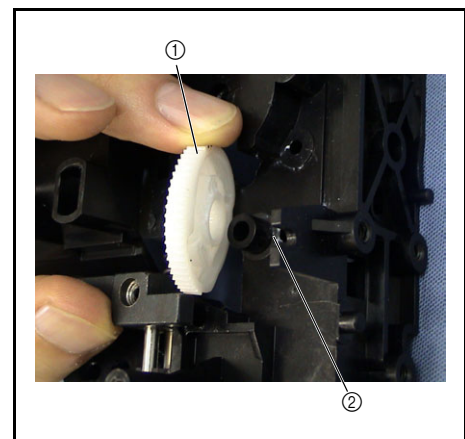

**44** Presser bar removal

1. Remove the retaining ring (E5) from the presser bar.
2. Remove the screw ❶ from the presser bar clamp assembly ❶, and then pull the presser bar downward.
3. Remove the presser bar clamp assembly ❶ and the spring S60.
4. Remove the screw ❷, and then remove the plate spring ❷ and the presser bar bushing ❸.

Retaining ring E5

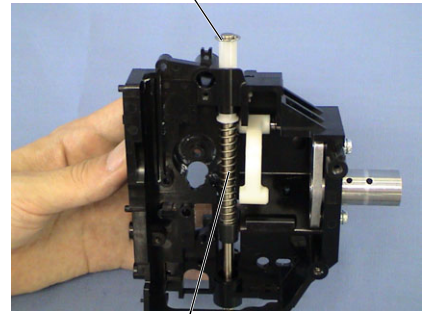

S60

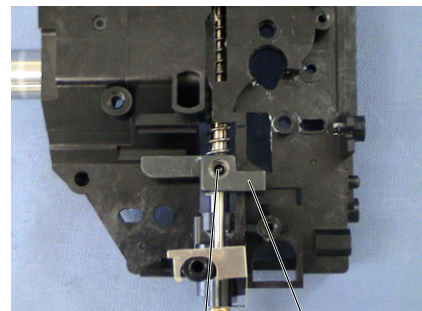

❶

❶

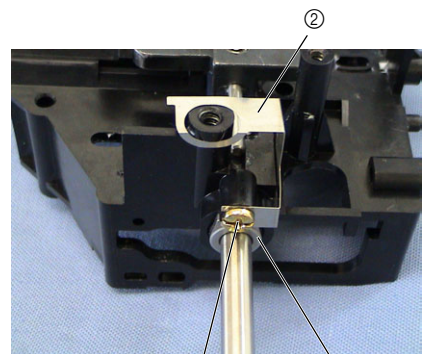

❷

❸



#### 45 Thread take-up lever link removal

1. Remove the screw ❶.
2. Remove the retaining ring (E4).

**\*Key point**

- Move the spring S06 to the thread take-up lever link ❷.
3. Pull out the shaft ❶, and then remove the spring S06 and the thread take-up lever link ❷.

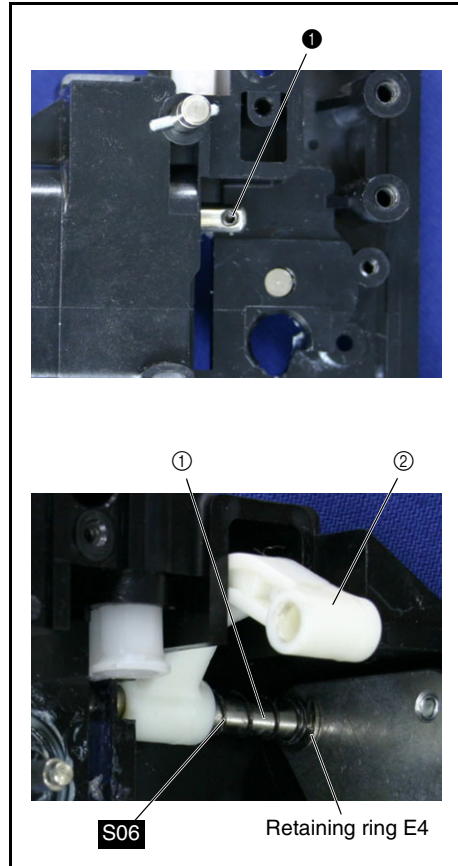

#### 46 Shaft bushing assembly removal

1. Remove the 2 screws ❶, and then remove the shaft bushing assembly ❶.

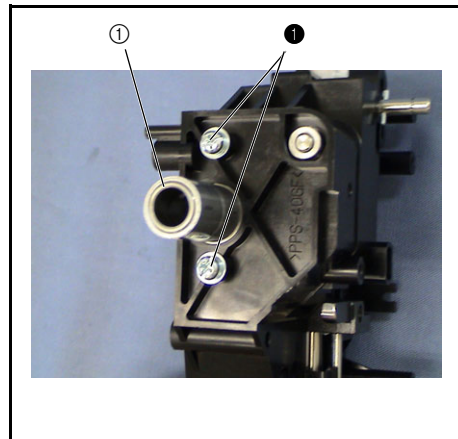

#### 47 Presser dial gear removal

1. Pull out the presser dial shaft assembly ❶.
2. Remove the presser dial gear ❷ and the presser foot rack ❸.

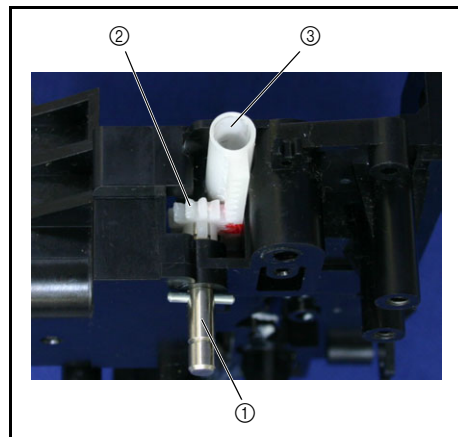

Feed/rotary hook module location diagram

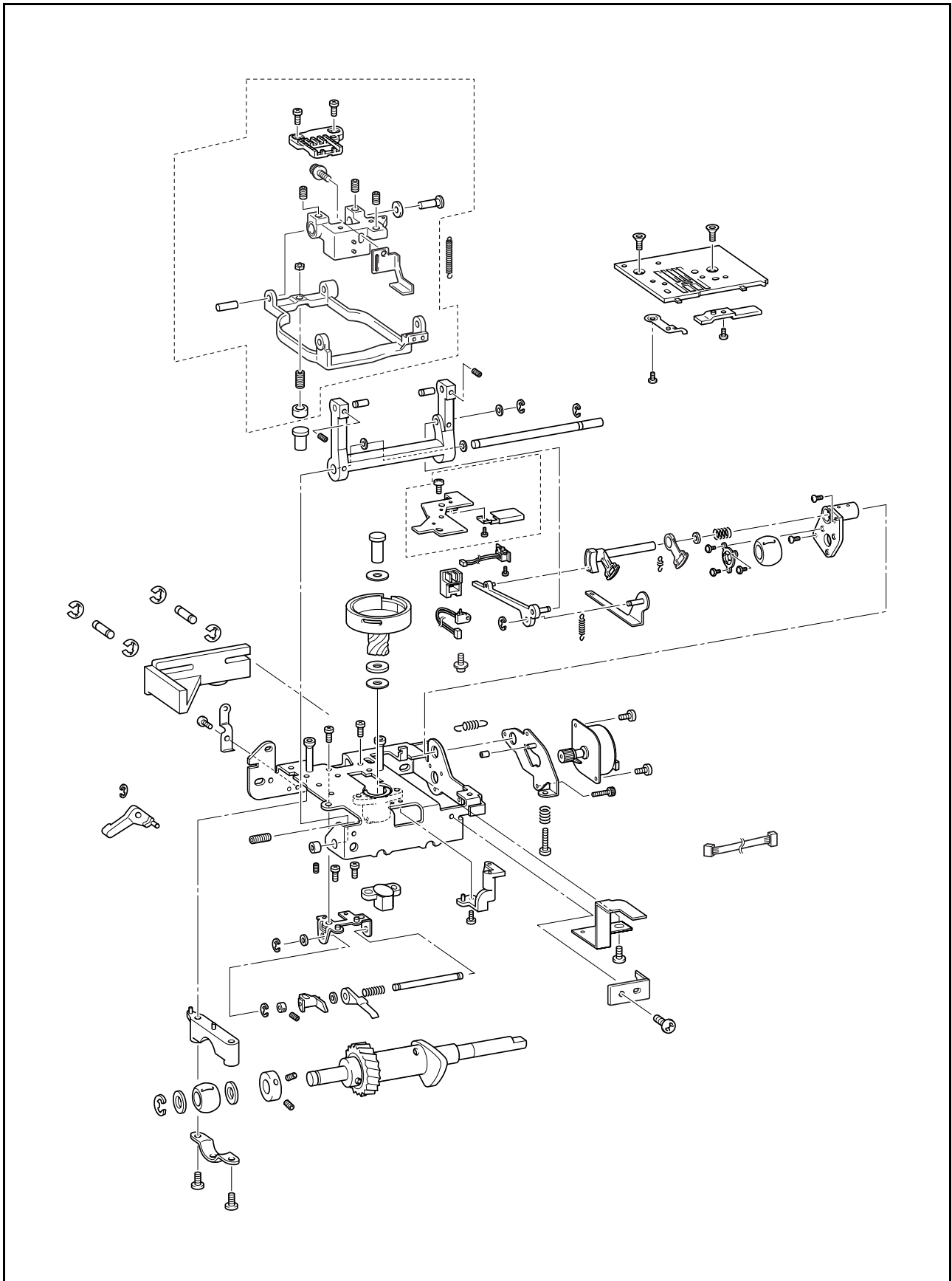

**1 Drop knob removal**

1. Remove the screw ❶, and then remove the plate spring ❶.
2. Remove the retaining ring (E3), and then remove the drop knob ❷.

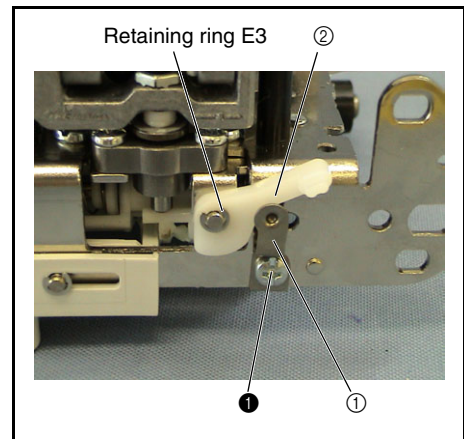
**2 Drop lever removal**

1. Remove the retaining ring (E2) on 2 slide shafts A ❶ from the rear of the drop lever ❷.
2. Remove 2 slide shafts A ❶ from the front of the drop lever ❷, and then remove the other retaining ring (E2) on 2 slide shafts A ❶.
3. Remove the drop lever ❷.

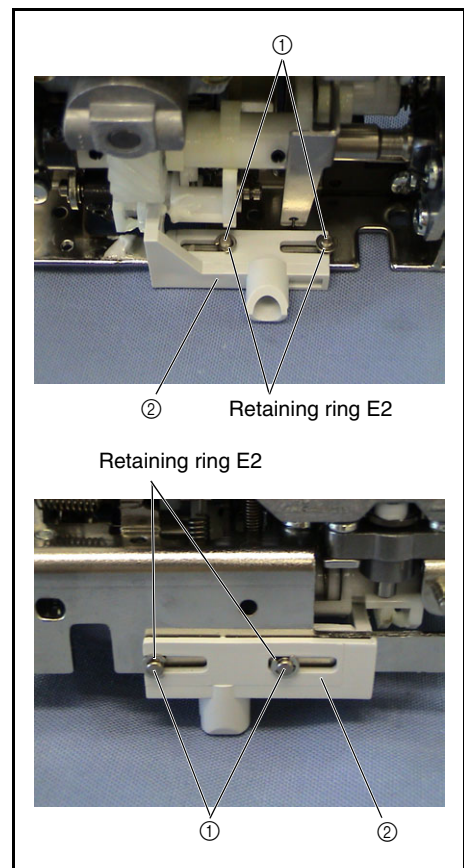
**3 Needle plate A removal**

1. Remove the 2 screws ❶, and then remove needle plate A ❶.

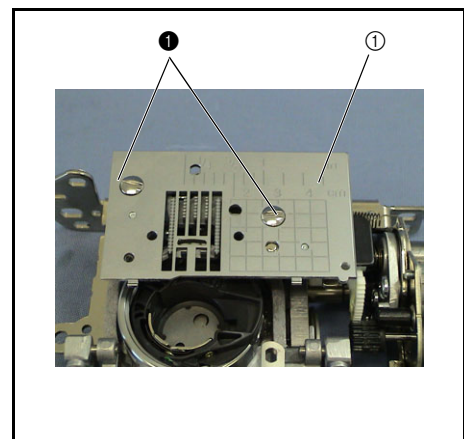

#### 4 Needle plate A disassembly

1. Remove the 3 screws ❶, and then remove the stopper plate ❶, stopper plate ❷, and needle plate B support plate ❸.

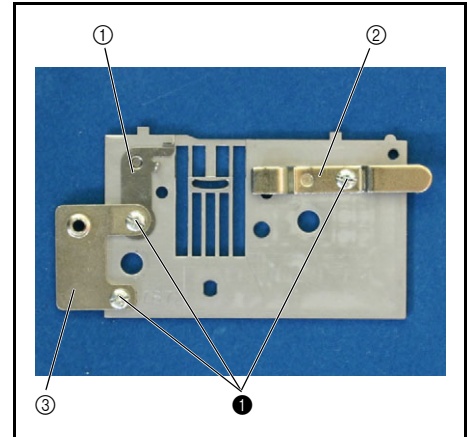

#### 5 Inner rotary hook bracket assembly removal

1. Remove the screw ❶, and then remove the inner rotary hook bracket assembly ❶.

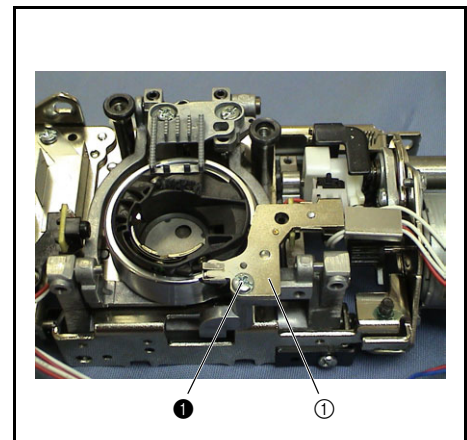

#### 6 Cord holder removal

1. Remove the screw ❶, and then remove the cord holder ❶.

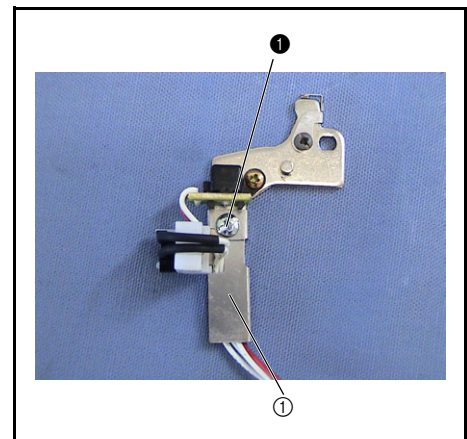

#### 7 Needle plate switch ASSY removal

1. Remove the PLT SW assembly (D6) ❶ from the needle plate switch holder ❷.

**\*Key point**

- Disengage the hook on the needle plate switch holder.

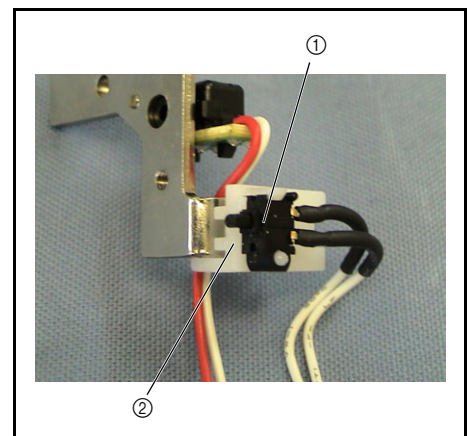

### 8 Photo diode holder assembly removal

1. Remove the screw ❶, and then remove the photo diode holder assembly ❶.

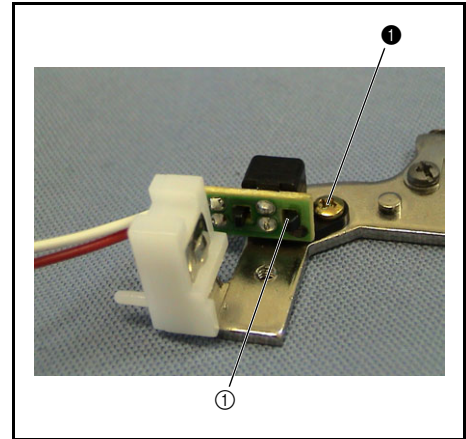

### 9 Photo diode holder ASSY disassembly

1. Remove the photo diode holder assembly ❶ from the photodiode holder ❷.

**\*Key point**

- Disengage the 2 hooks on the photo diode holder ❷.

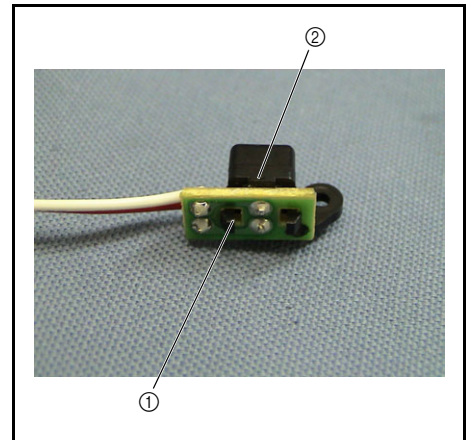

### 10 Feed dog removal

1. Remove the 2 screws ❶, and then remove the feed dog ❶.

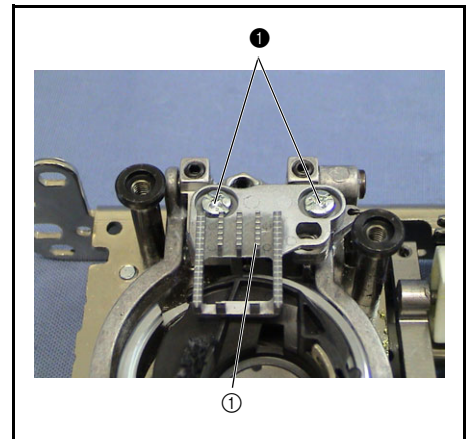



## 11 Outer rotary hook removal

1. Remove the screw ❶, and then remove the outer rotary hook shaft ❶.

**\*Key point**

- Press the bottom of the outer rotary hook shaft ❶, and then pull the outer rotary hook shaft ❶ out from the outer rotary hook assembly ❸.

2. Remove the spacer ❷, outer rotary hook assembly ❸, washer ❹, and spacer ❺.

**\*Key point**

- Rotate the outer rotary hook assembly ❸ counterclockwise to remove it.

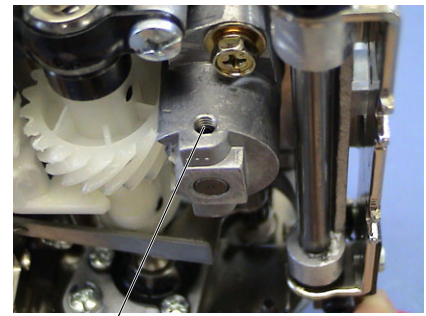

❶

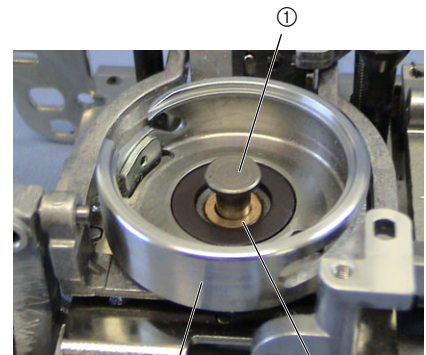

❶

❸

❷



❺

❹

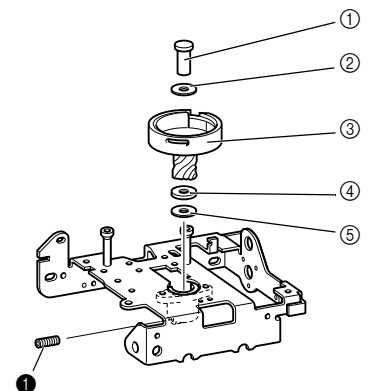

❶

❷

❸

❹

❺

❶

**12** Spring removal

1. Remove the spring **S63**.

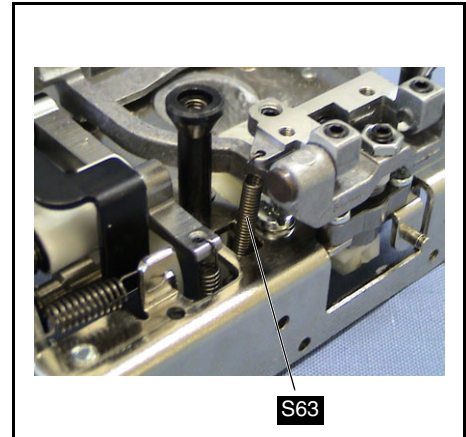
**13** Feed bar assembly removal

1. Remove the 2 screws **1**, and then pull out the 2 feed bar shafts A **1**.
2. Remove the feed bar assembly **2**.

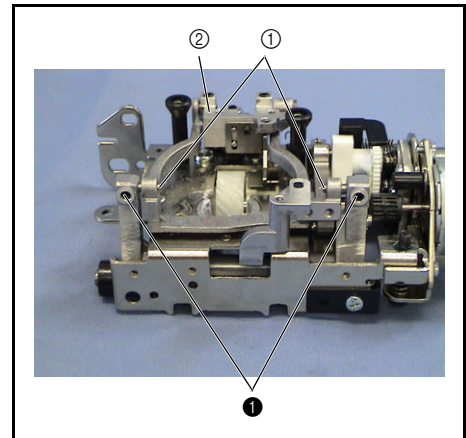
**14** Feed dog base assembly removal

1. Remove the screw **1**, and then pull out the feed dog base shaft B **1**.
2. Remove the screw **1**, pull out the feed dog base shaft A **2**, and then remove the polyester slider **3**.
3. Remove the feed dog base assembly **4**.

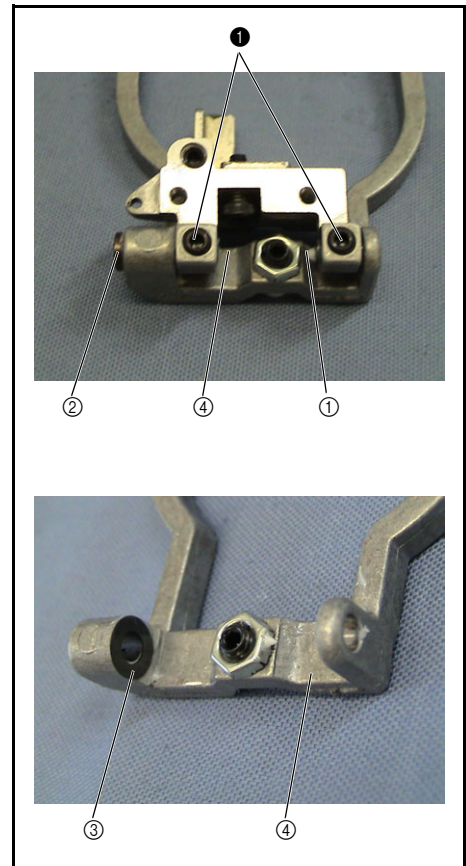

**15** Feed dog correction plate removal

1. Remove the screw ❶, and then remove the feed dog correction plate ❶.

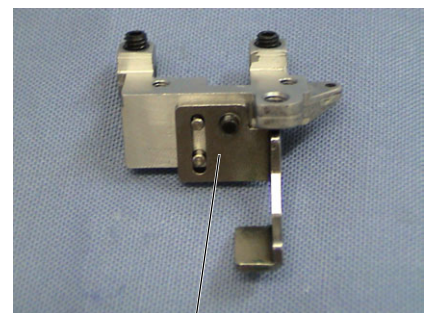
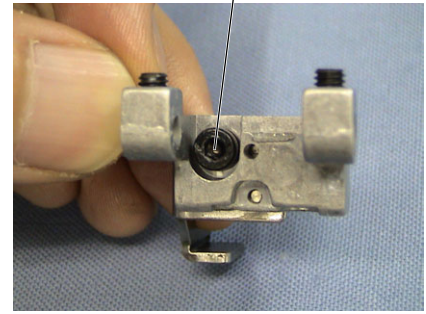
**16** Vertical adjusting screw removal

1. Remove the screw ❶, and then remove the M5 nut ❶.
2. Remove the cap ❷ from the bottom of the screw ❶.

**17** Vertical rod removal

1. Pull out the vertical rod ❶.

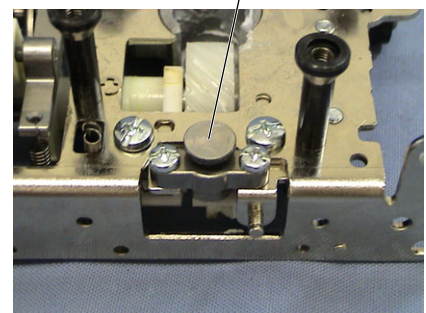



**18** Vertical feed bush removal

1. Remove the 2 screws ❶, and then remove the vertical feed bush ❶.

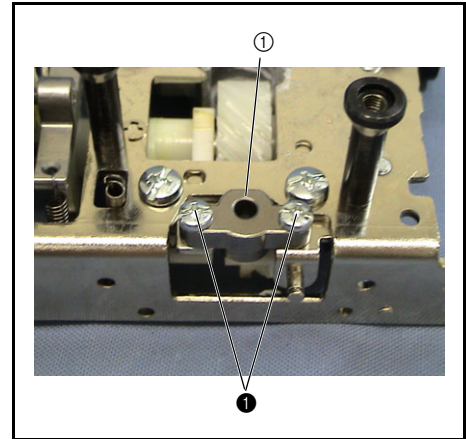
**19** Spring removal

1. Remove the spring S16.

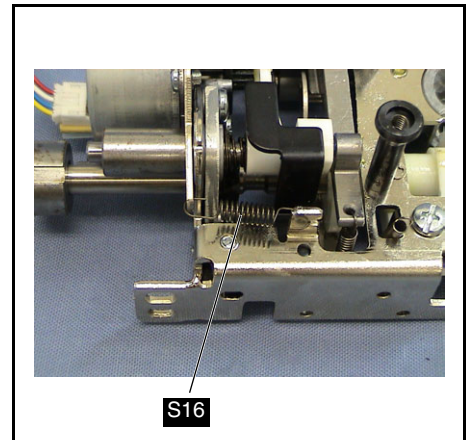
**20** F gear stopper plate removal

1. Remove the screw ❶, and then remove the F gear stopper plate ❶.

**\*Key point**

- Remove the screw ❶ from the bottom of the F gear stopper plate ❶, and then lift the plate upward to remove it.

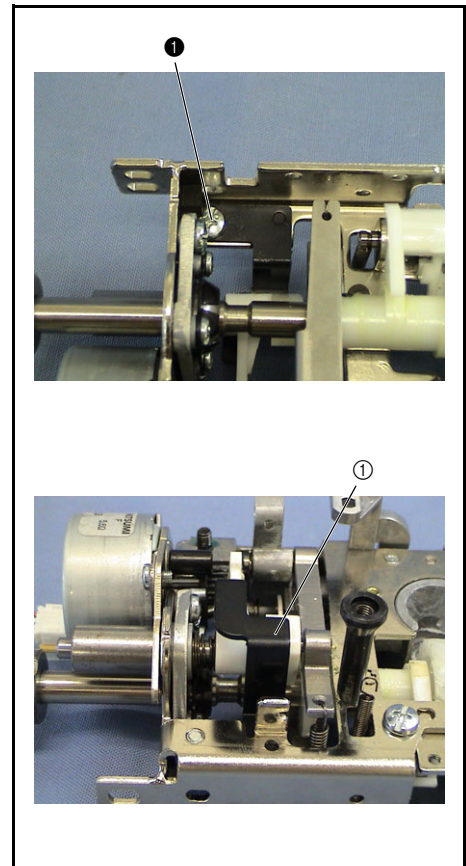

**21** F pulse motor holder assembly removal

1. Remove the screws ① ②, and then remove the spring S15 and the F pulse motor assembly ①.

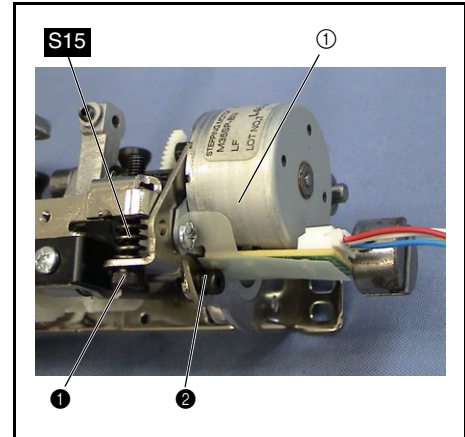
**22** F pulse motor holder ASSY disassembly

1. Disconnect the F pulse motor lead wire assembly ② from the pulse motor (M35SP-8N) ①.
2. Remove the 2 screws ①, and then remove the pulse motor (M35SP-8N) ① from the F pulse motor holder ③.
3. Remove the rubber ④ from the shaft of the F pulse motor holder ③.

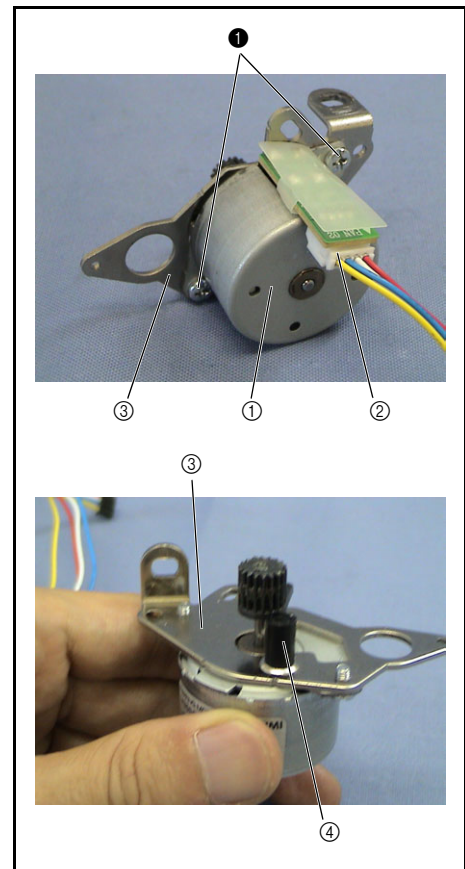
**23** Spring removal

1. Remove the spring S37 from the bottom.

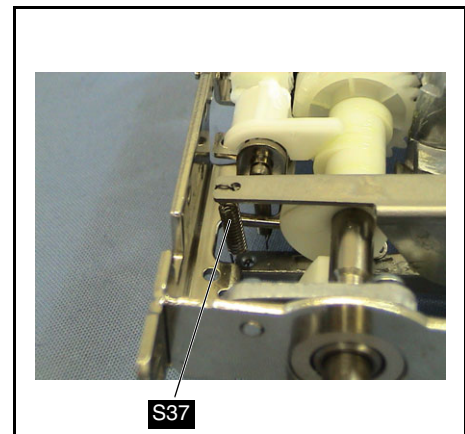

**24** Shaft stopper plate removal

1. Remove the screw ❶, and then remove the shaft stopper plate ❶.

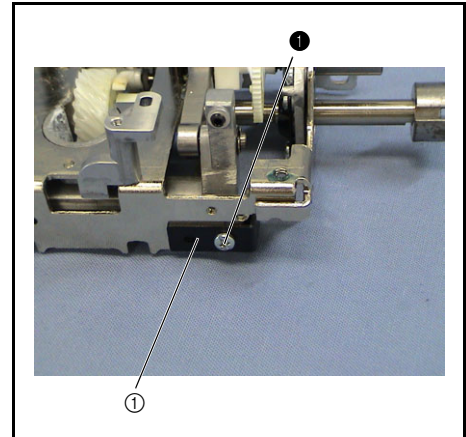
**25** Set screw collar removal

1. Remove the screw ❶, and then remove the set screw collar ❶.

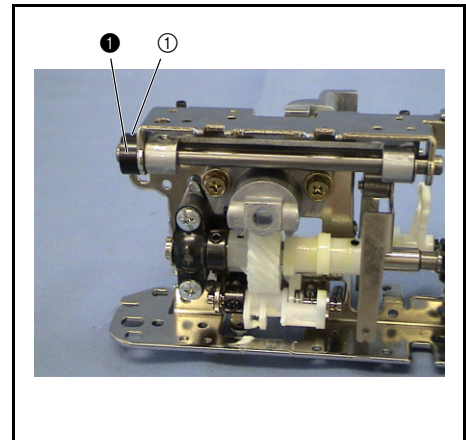
**26** Feed arm assembly removal

1. Remove the retaining ring (E5) of the horizontal feed shaft ❶.
2. Pull the horizontal feed shaft ❶ to the left to remove it, and then remove the 2 thrust washers ❷.
3. Remove the feed arm assembly from the bottom of the feed/rotary hook module.

**\*Key point**

- When removing the feed arm assembly, slide the feed adjuster ❸ to the right, and then remove the feed regulator slide shaft of feed arm B ❹.

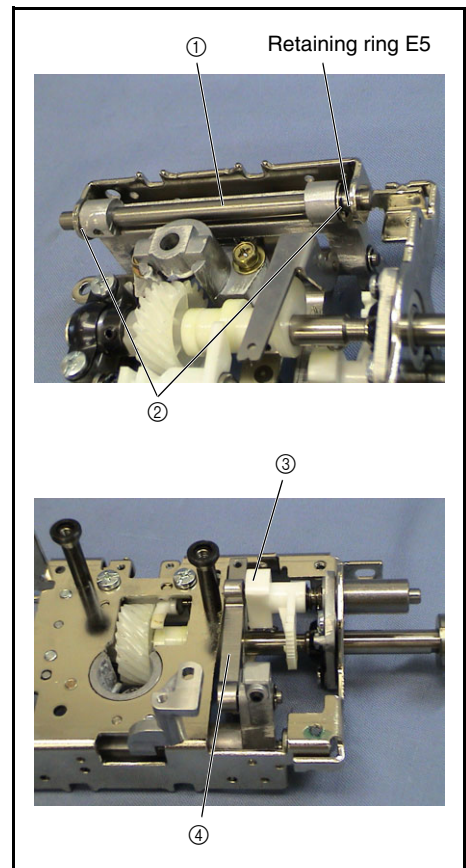

### 27 Feed arm ASSY disassembly

1. Remove the retaining ring (E3), and then remove the polyester slider ② and the feed arm B assembly ③ from feed arm A ①.
2. Remove the retaining ring (E2), and then remove the feed supporting plate ⑤ from feed arm B ④.

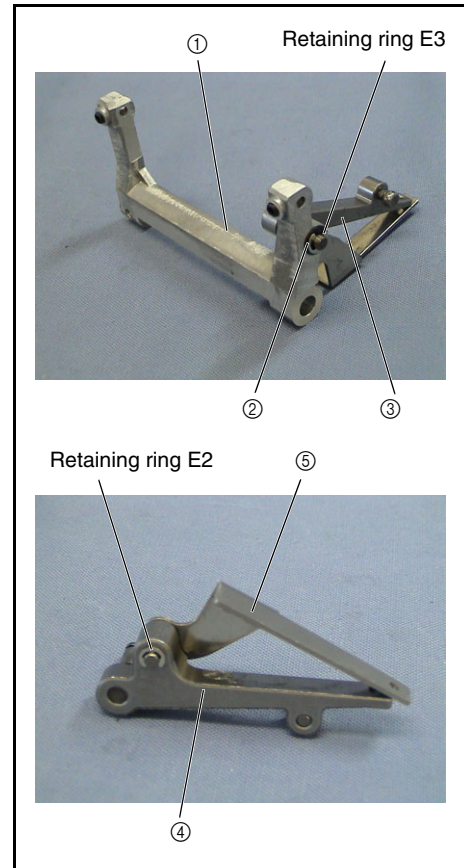

### 28 Lower shaft B assembly removal

1. Remove the 2 screw ①, and then remove the joint ①.
2. Remove the 2 screws ②, and then remove the bushing presser A ②.
3. Lift the left end of the lower shaft B assembly ③ slightly, and then pull it to the left to remove it.
4. Remove the bushing supporter A ④.

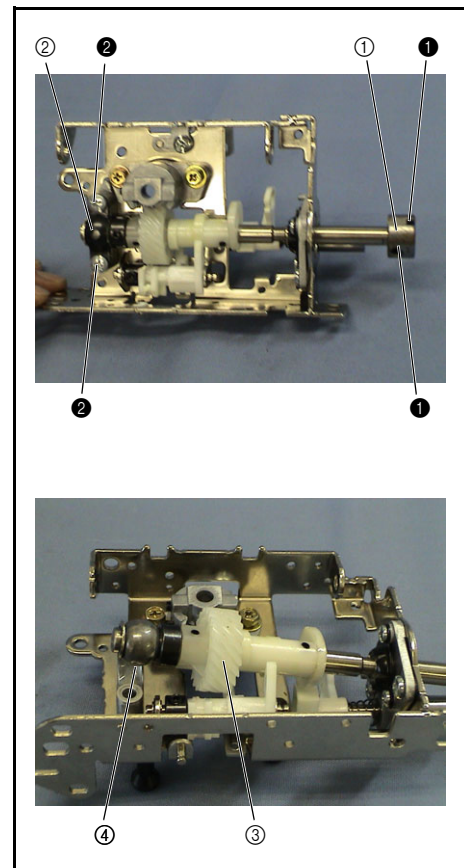



### 29 Lower shaft B ASSY disassembly

1. Remove the retaining ring (E6), and then remove the 2 screw ① of the set screw collar ①.
2. Remove the thrust washer ③, lower shaft bushing ④, thrust washer ③, and set screw collar ① from the lower shaft B assembly ②.

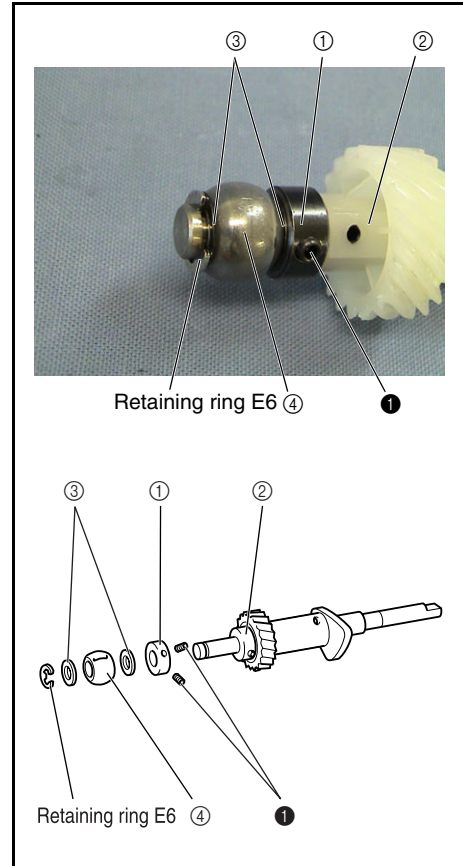

### 30 Stopper plate block removal

1. Remove the screw ① from the bottom of the stopper plate block ①, and then remove the stopper plate block ①.

**\*Key point**

- Rotate the stopper plate block ① clockwise to remove it.

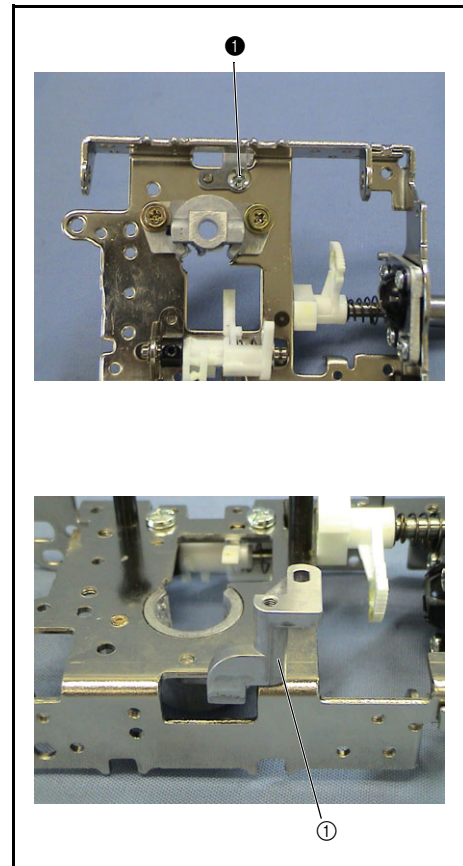

### 31 Drop assembly removal

1. Remove the 2 screws ❶, and then remove the drop assembly ❶ from the bottom.

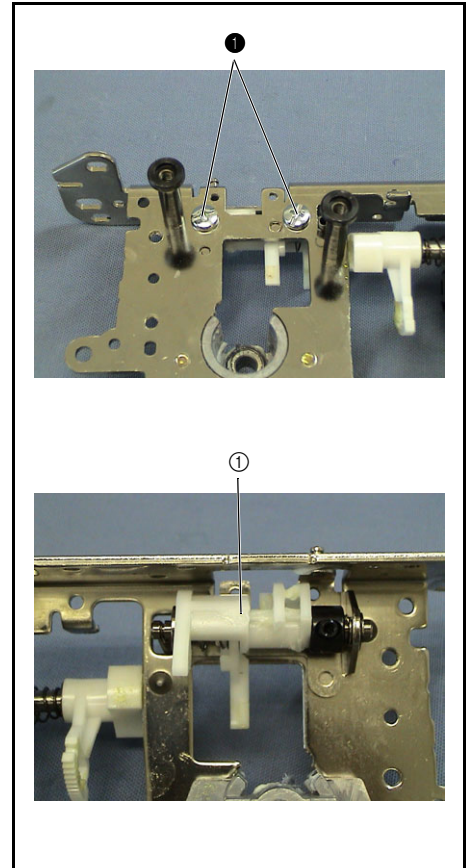

### 32 Drop ASSY disassembly

1. Remove the screw ❶ to free the set screw collar ❶.
2. Remove the retaining ring (E3) between the vertical supporting plate ❷ and the set screw collar ❶.

**\*Key point**

- Slide the set screw collar ❶ to the left to remove the retaining ring (E3).

3. Pull the vertical feed shaft ❸ to the right to remove it, and then remove the polyester slider ❹ and the retaining ring (E3).
4. Remove the spring **S57**, the feed dog correction lever ❺, polyester slider ❻, vertical lever ❼, and set screw collar ❶.

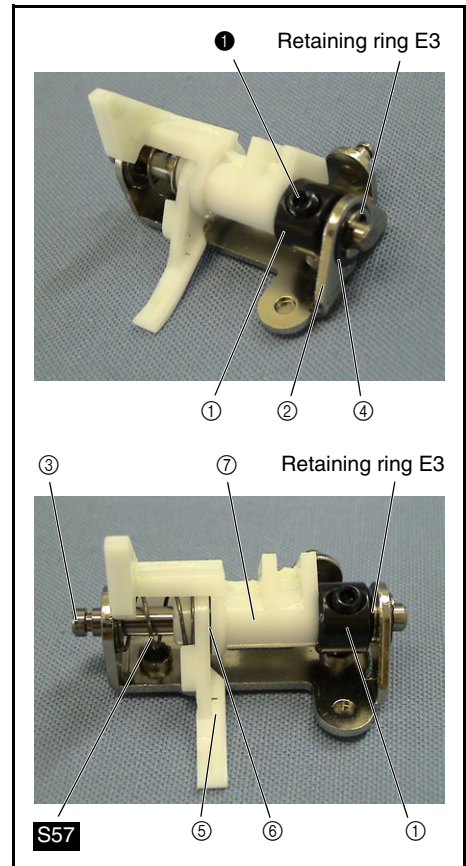

**33** Feed adjuster assembly removal

1. Remove the 2 screws ①, and then remove the bushing supporter assembly ①, feed adjuster assembly ②, and spring S14.

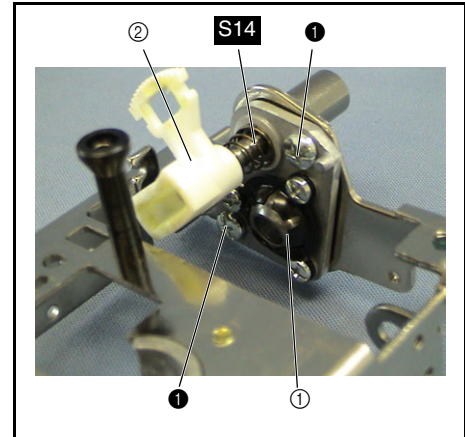
**34** Feed adjuster ASSY disassembly

1. Remove the polyester slider ② from the adjusting shaft ①.
2. Remove the spring S13, and then remove the F gear ④ from the feed adjuster ③.

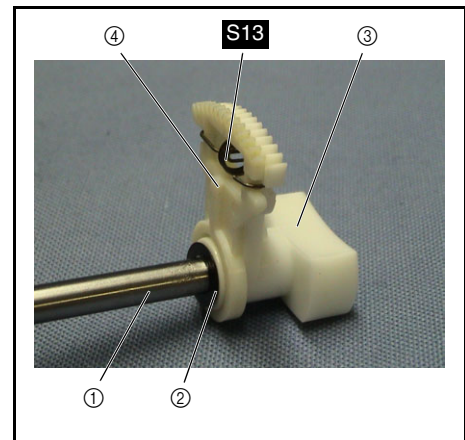
**35** Bushing presser B removal

1. Remove the 3 screws ①, and then remove the bushing presser B ① and the lower shaft bushing ②.

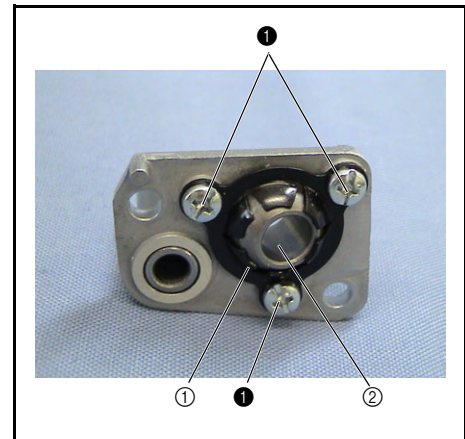

Side feed module location diagram

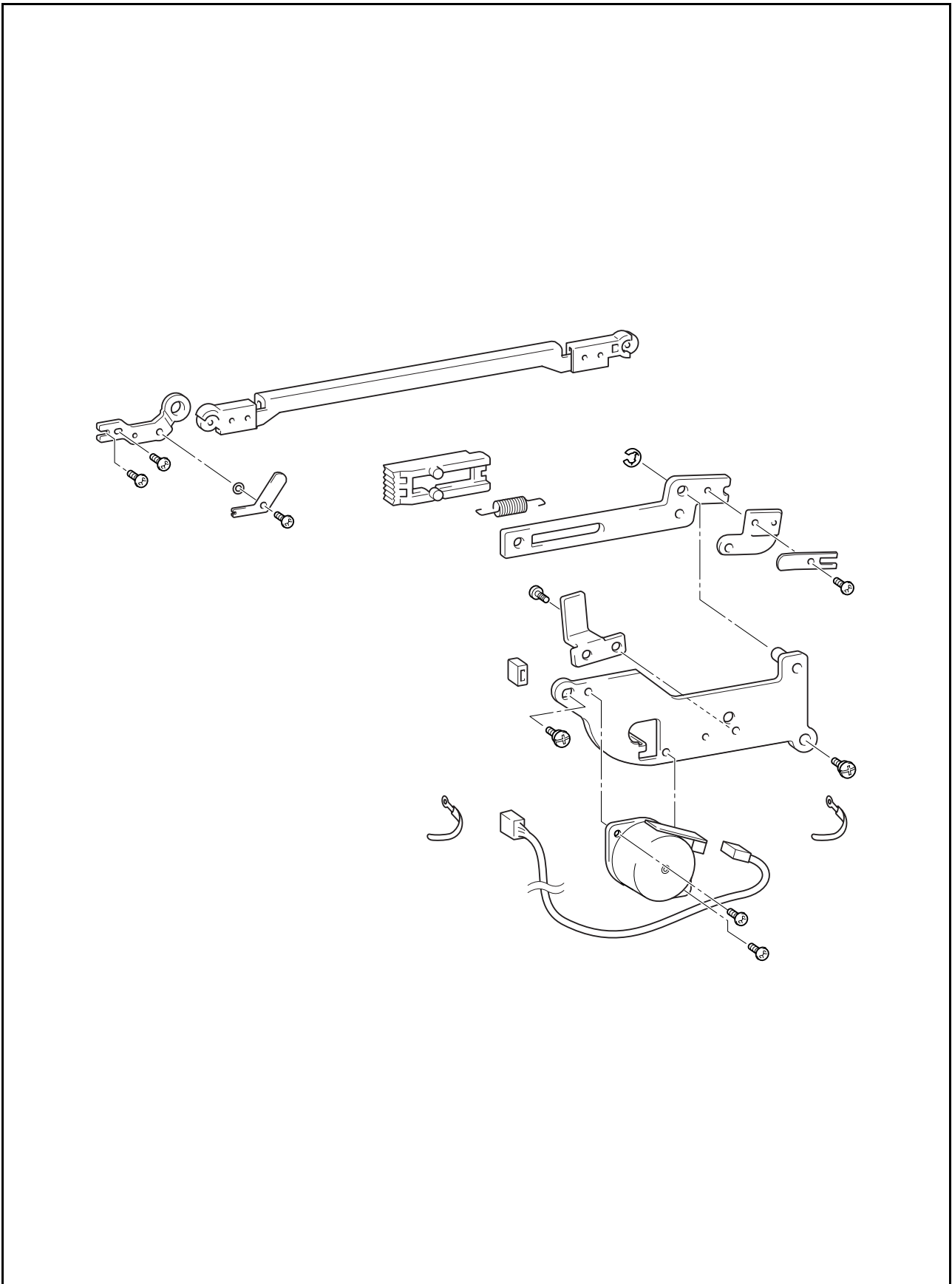



## 1 Side feed arm assembly removal

1. Remove the screw ❶, and then remove the plate spring A ❶ and the side feed arm assembly ❷.

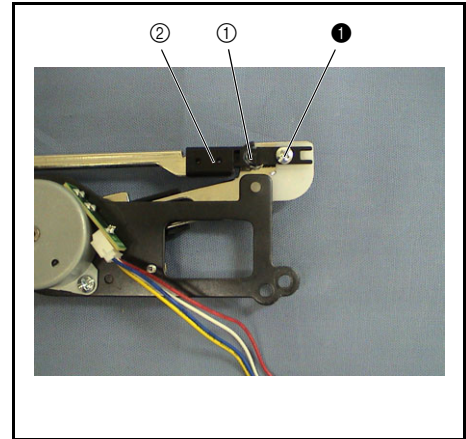

## 2 Side feed adjust plate removal

1. Remove the screw ❶, and then remove the plate spring B ❶, washer ❷, and side feed adjust plate ❸.

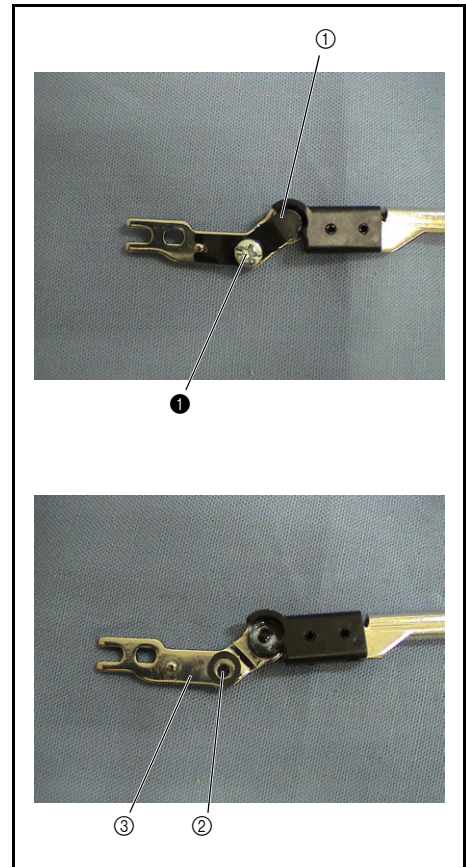

### 3 Side feed gear removal

1. Remove the rubber ①.
2. Remove the screw ①, and then remove the S stopper ②.
3. Slide the S gear ③ to disengage it from the S pulse motor gear ④.
4. Remove the spring **S41** from the S gear ③, then pull out the S gear ③ from the side feed plate ⑤.
5. Pull out the S gear ③ from the side feed plate ⑤.
6. Remove the retaining ring (E3), and then remove the side feed plate ⑤.
7. Remove the screw ②, and then remove the spring plate A ⑦ and the side feed washer ⑥.

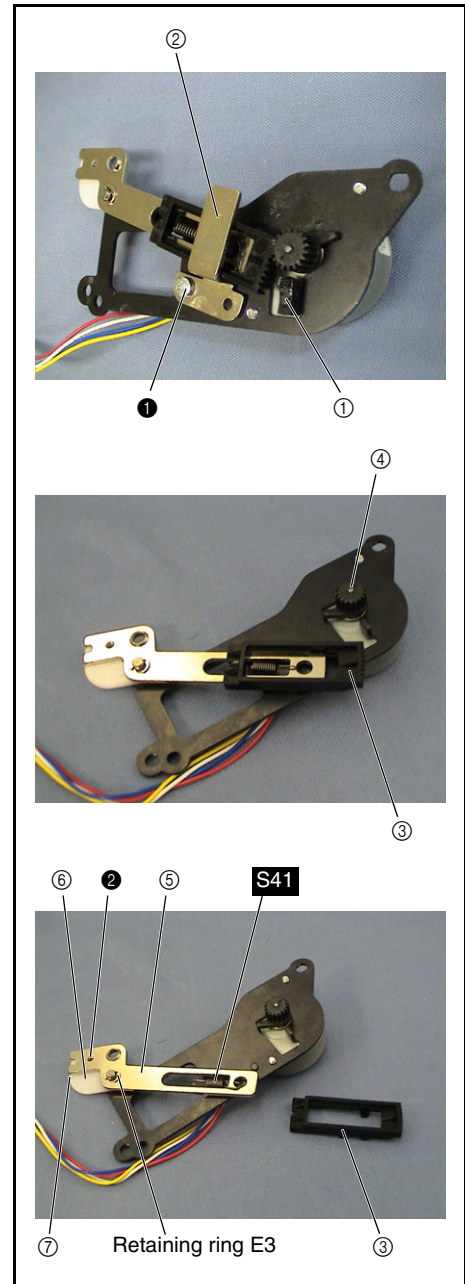

### 4 S pulse motor removal

1. Remove the 2 screws ①, and then remove the S pulse motor ① from the S pulse motor holder ②.

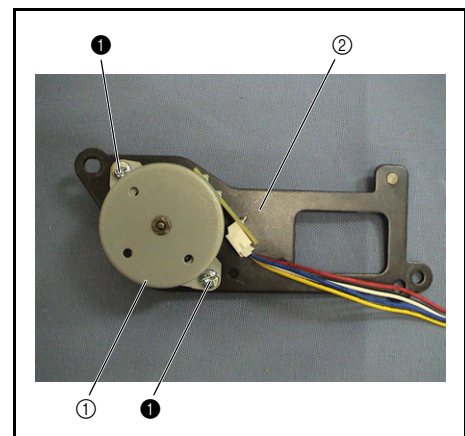

Thread cutter module location diagram

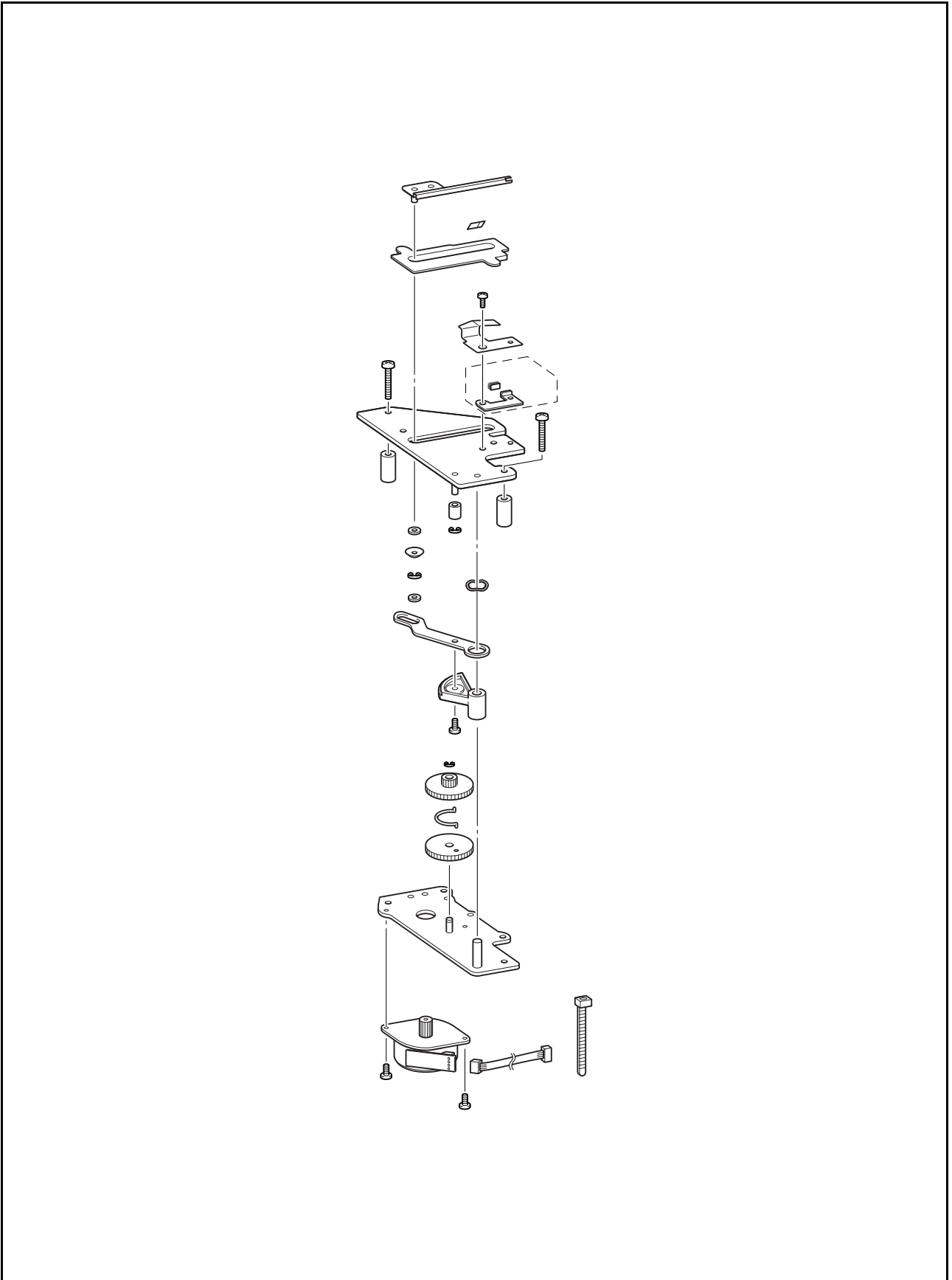

## 1 Thread cutter frame assembly removal

1. Cut the band.
2. Remove the 2 screws ❶, then remove the thread cutter frame assembly ❶ from the motor holder assembly ❷, and then remove the 2 collars.

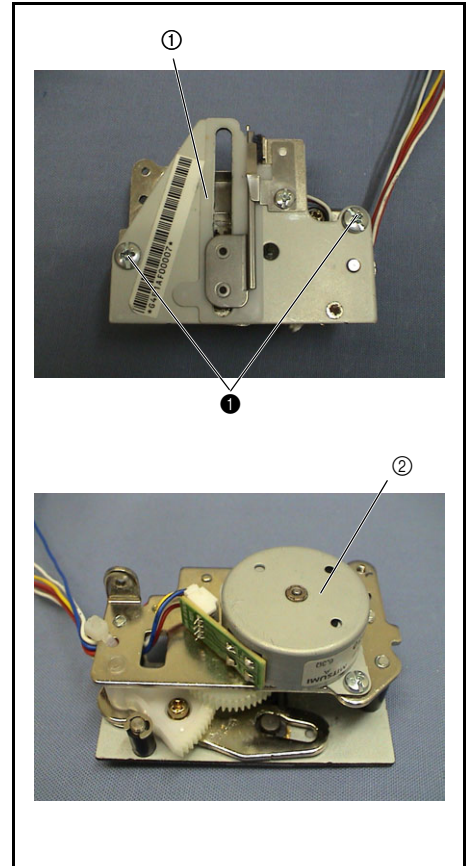

## 2 Presser plate assembly removal

1. Remove the screw ❶, and then remove the presser plate ❶ and the plate spring ❷.

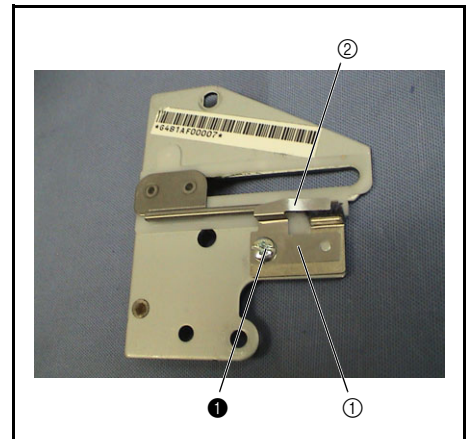

### 3 Thread hook ASSY disassembly

1. Remove the retaining ring (E4), and then remove the washer ① and the polyester slider ②.
2. Reverse the thread cutter frame ③, and then remove the thread hook assembly ④ and the spacer ⑤.
3. Remove the lower thread cutter ⑥ from the spacer ⑤.

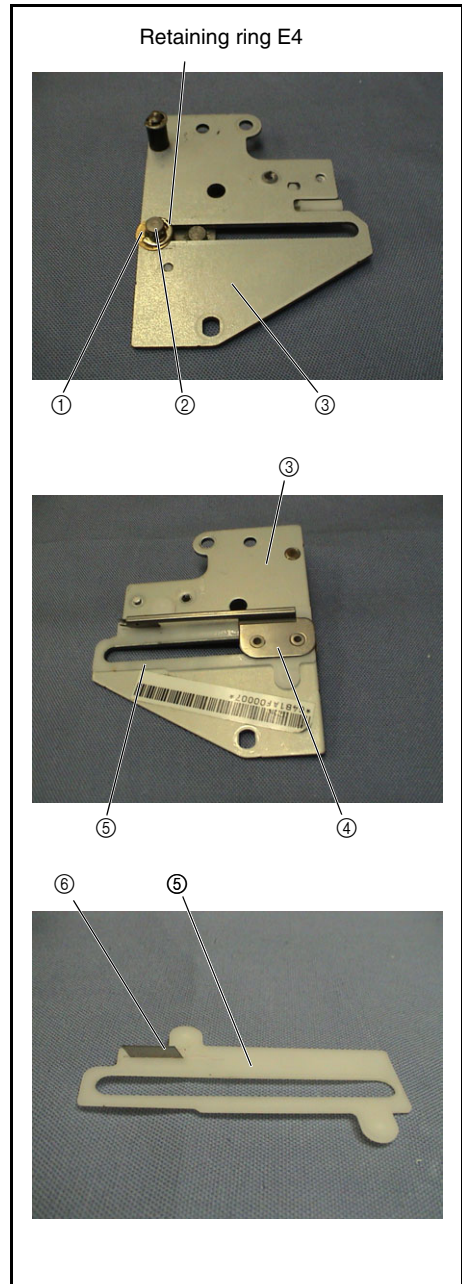

### 4 Rubber removal

1. Remove the retaining ring (E3), and then remove the rubber ①.

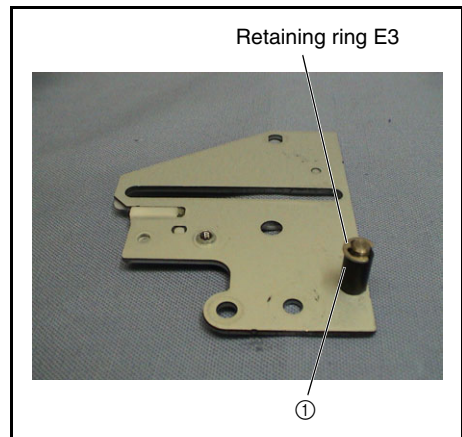



**5** Thread cutter lever assembly removal

1. Slide the thread cutter lever assembly ① to remove it from the idle gear ②, and then remove it from the thread cutter lever shaft ③.

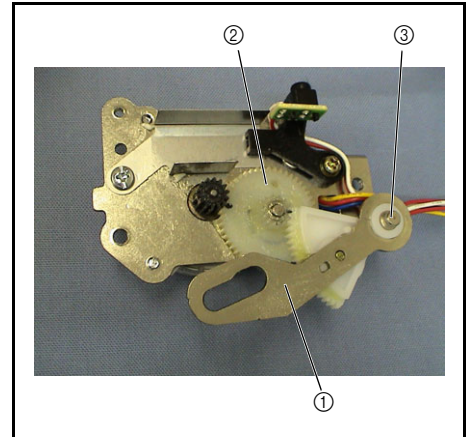
**6** Thread cutter lever ASSY disassembly

1. Remove the screw ①, and then remove the thread cutter lever gear ① from the thread cutter lever ②.

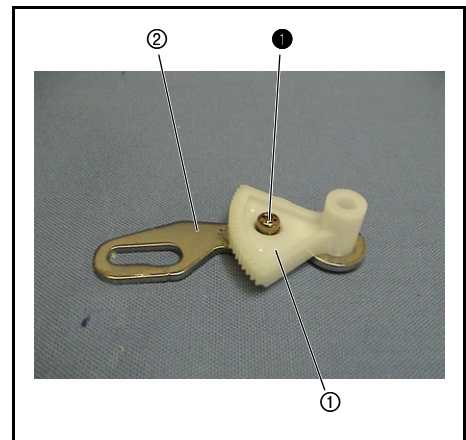
**7** Photo transistor assembly removal

1. Remove the screw ①, and then remove the photo transistor assembly ①.

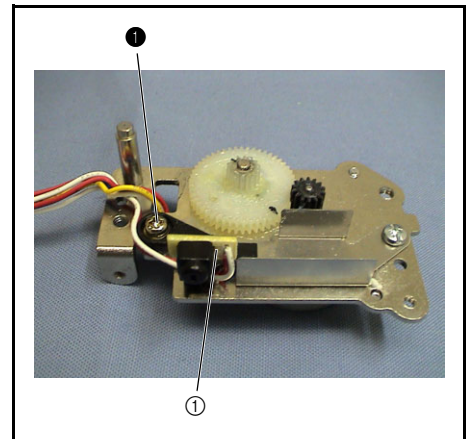

**8** Idle gears A and B removal

1. Remove the retaining ring (E2), and then remove idle gear A ①, spring ②, and idle gear B ③.

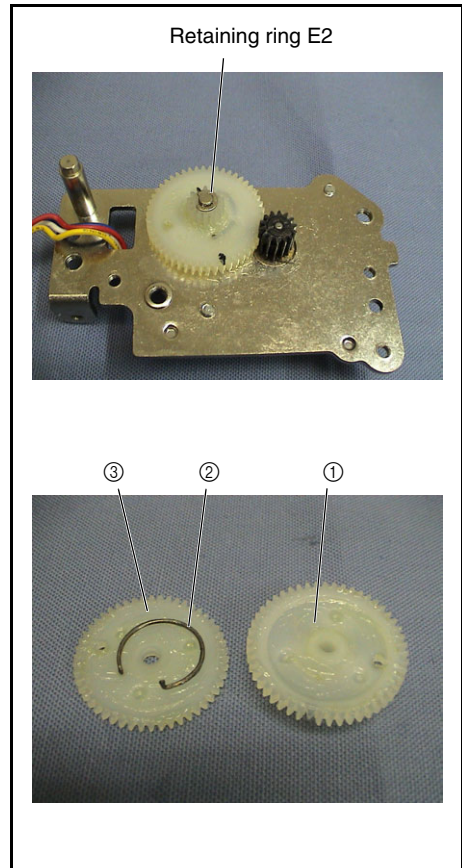
**9** Z pulse motor assembly removal

1. Disconnect the lead wire connector ② from the PCB of the Z pulse motor assembly ①.
2. Remove the 2 screws ①, and then remove the Z pulse motor assembly ① from the motor holder assy ③.

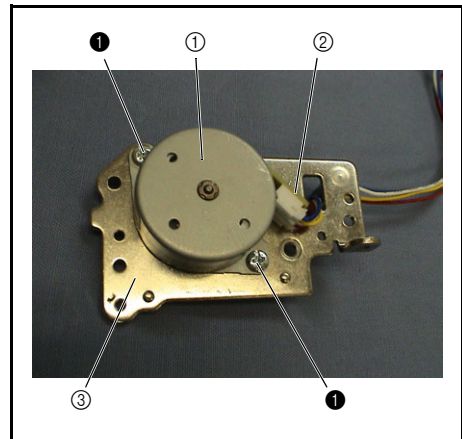



Main parts location diagram

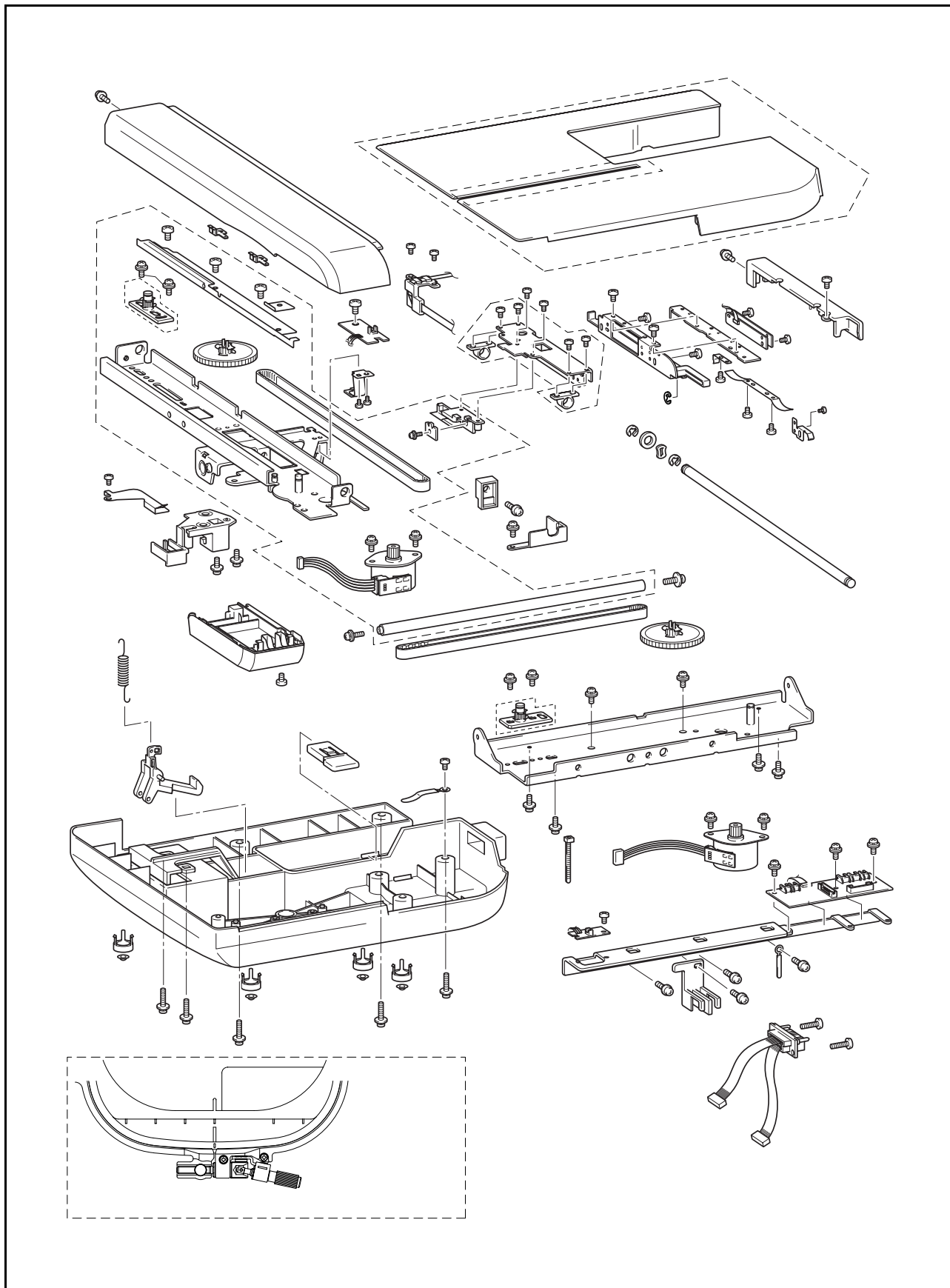

## 1 YPM cover removal

1. Position the embroidery unit assembly with the main unit attachment section ① on the right.
2. Remove the screw ①, and then remove the YPM cover ②.

### \*Key point

- Slide the YPM cover toward you, and disengage the 2 hooks ④ inside of the YPM cover ②.
- Disengage the hook ⑥ of the X carriage cover ⑤.

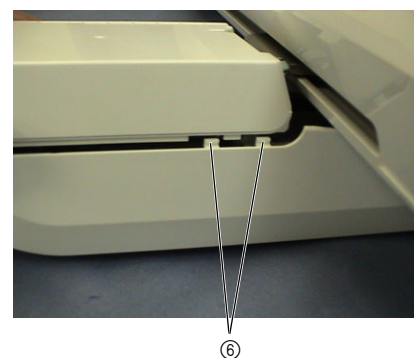
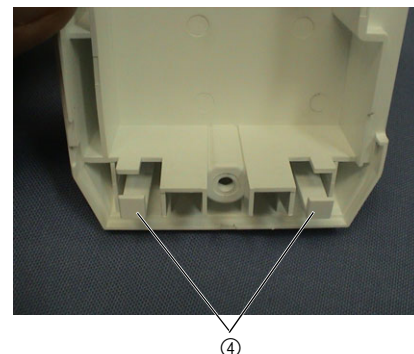
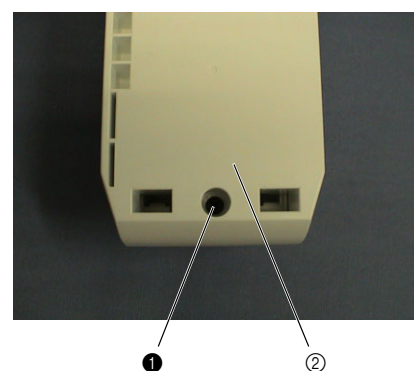
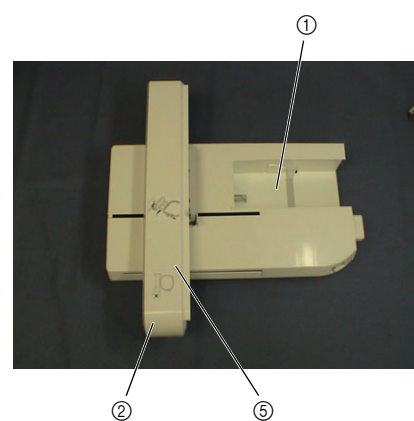

## 2 X carriage cover removal

1. Position the embroidery unit assembly with the main unit attachment section ① on the left.
2. Remove the screw ①, and then remove the X carriage cover ②.

### \*Key point

- Remove the screw ① from the front of the indicated section ③ of the X carriage cover.
- Slide the X carriage cover backward to remove it.

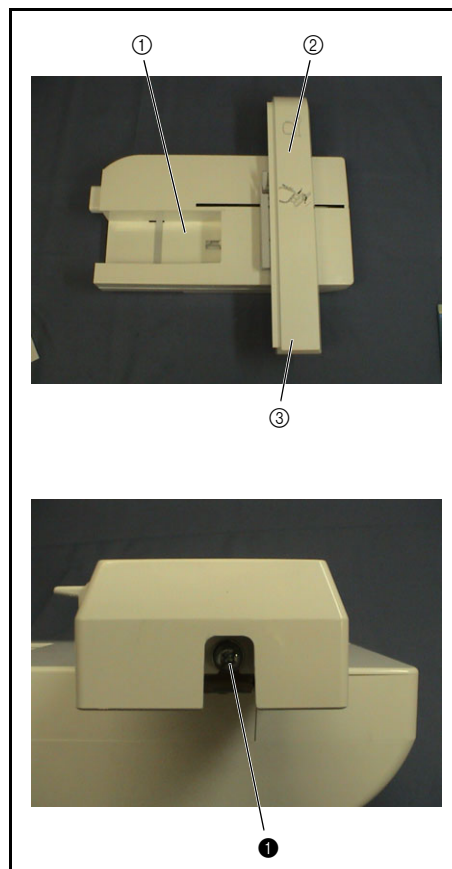

## 3 E hoop stay cover removal

1. Remove the screws ①, ②, and then remove the E hoop stay cover ①.

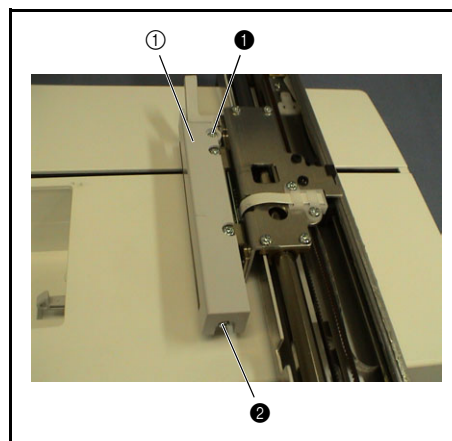

#### 4 ES main cover assembly removal

1. Remove the 9 screws (①x4 and ②x5), and then remove the ES main cover assembly ①.
  - \*Key point**
    - Remove the screws ①, ② from the bottom of the ES base cover assembly.
    - When removing the ES main cover only, remove the screws ②. To continue disassembly, also remove the screws ①.
2. Position the embroidery assembly with the main unit attachment section ② on the right.
3. Slide the X carriage assembly ③ to the left as far as possible.
4. Slide the ES main cover assembly ① to the right to remove it.

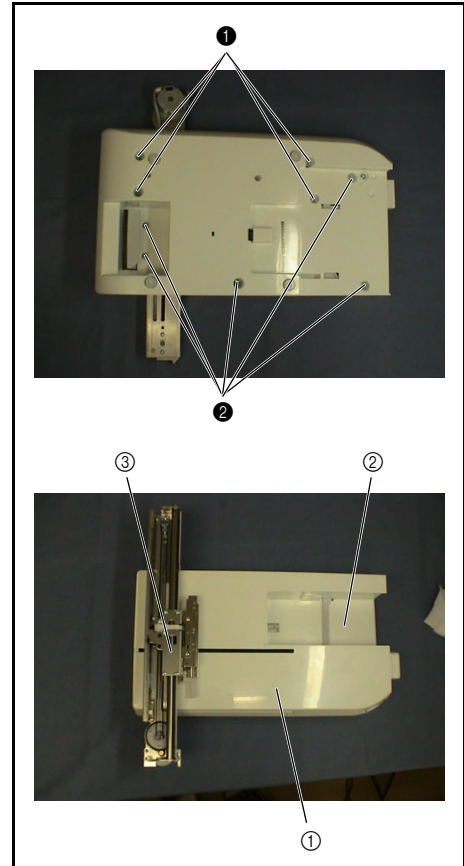

#### 5 EMB relay PCB assembly lead wire removal

1. Cut the band.
2. Disconnect the lead wire connector ① of the drop SW assembly, white lead wire connector ② and black lead wire connector ③ of the EMB unit lead wire assembly from the EMB relay PCB assembly ④.

**\*Key point**

- Remove the coating clip.

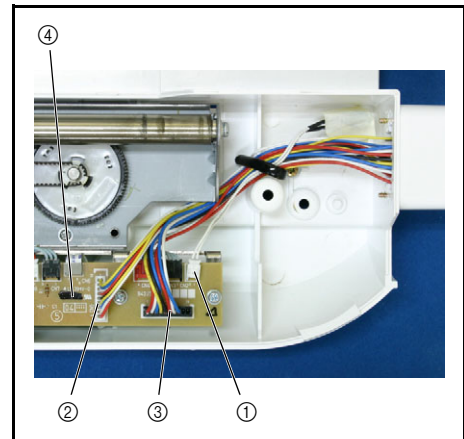

#### 6 EMB unit lead wire assembly removal

1. Remove the 2 screws ①, and then remove the EMB unit lead wire assembly ①.

**\*Key point**

- Move the EMB unit lead wire assembly ① to the outside of the ES base cover ②.

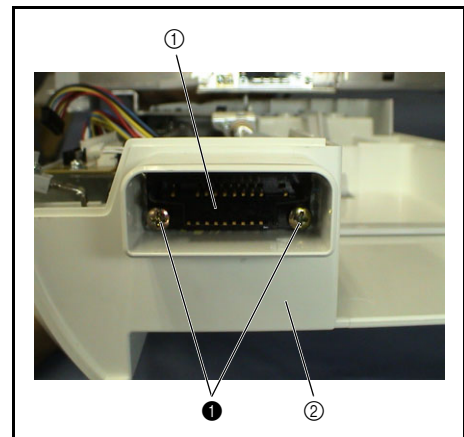

## 7 ES base cover assembly removal

1. Remove the 2 screws ①, and then remove the ES base cover assembly ①.

### \*Key point

- Remove the main frame assembly ②, and then remove the ES base cover assembly ①.

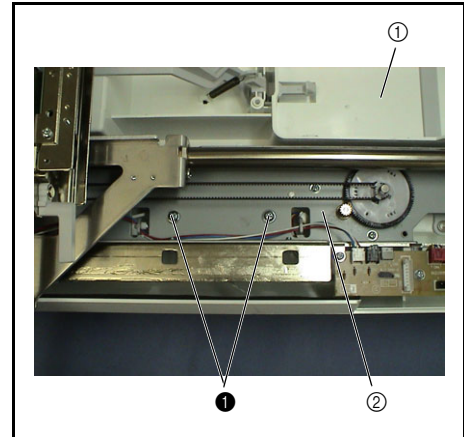

## 8 Lock release lever assembly removal

1. Remove the spring S64 from the lock finger ② of the lock release lever assembly ①.
2. Remove the lock release lever assembly ①.
3. Remove the spring S64 from the ES base cover.

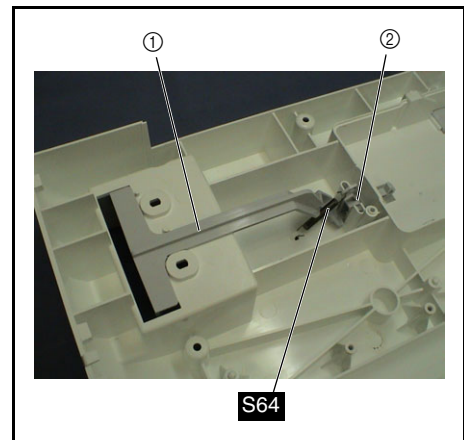

## 9 Lock release lever ASSY disassembly

1. Remove the lock finger ② from the lock release lever ①.

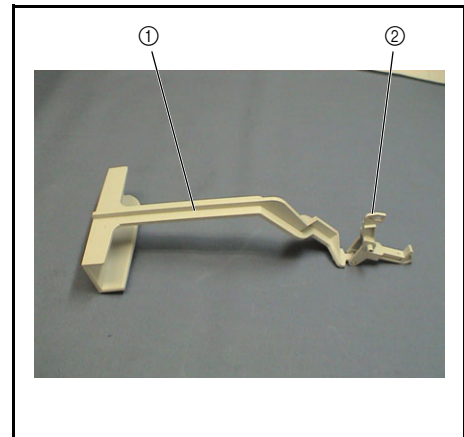

## 10 Drop trigger removal

1. Remove the drop trigger ①.

### \*Key point

- Push the hook on the drop trigger ① to remove the drop trigger.

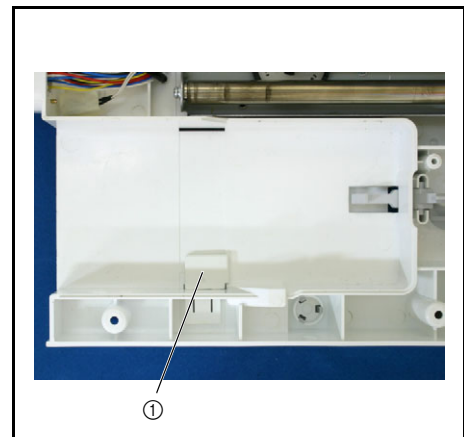

**11** EMB relay PCB assembly removal

1. Remove the 3 screws ❶, and then remove the EMB relay PCB assembly ❶.
2. Disconnect the 5 connectors from the EMB relay PCB assembly ❶.

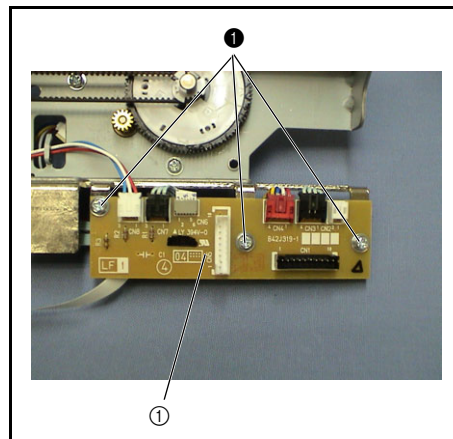
**12** E cord supporter cord removal

1. Disconnect the bundle of three cords from the E cord supporter ❶.

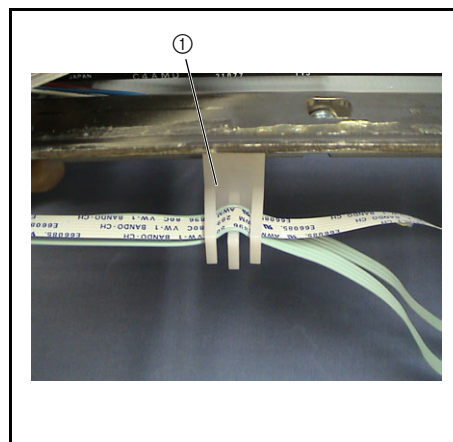
**13** E cord supporter removal

1. Remove the screw ❶, and then remove the E cord supporter ❶.

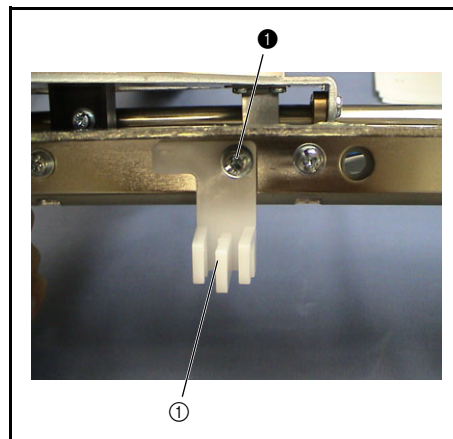



**14 X sensor PCB assembly cord removal**

1. Slide the X carriage assembly ① of the main frame assembly to the right as far as possible.
2. Cut the band from the left hook ② on the bottom of the main frame, and then disconnect the lead wire of the X sensor PCB assembly ③.
3. Slide the X carriage assembly ① of the main frame assembly to the left as far as possible.
4. Disconnect the lead wire of the X sensor PCB assembly ③ from the right hook ④ on the bottom of the main frame.

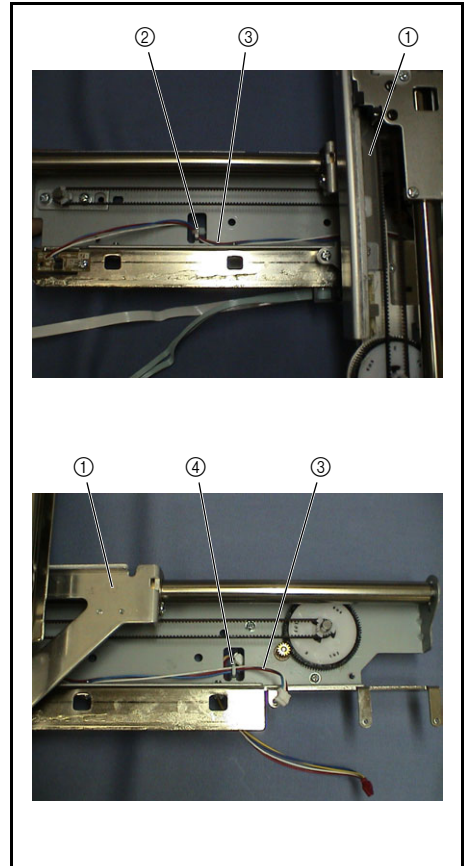
**15 X sensor PCB assembly removal**

1. Slide the X carriage assembly of the main frame assembly to the right limit.
2. Remove the screw ❶, and then remove the X sensor PCB assembly ❶.

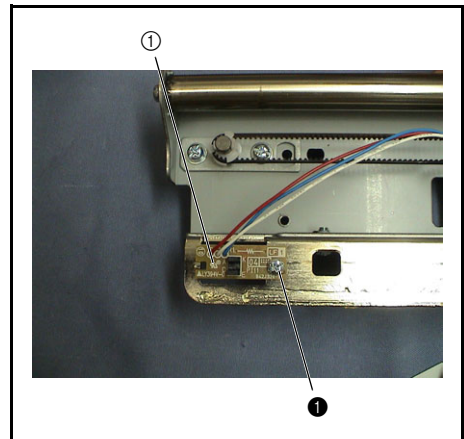
**16 X belt presser removal**

1. Remove the screw ❶, and then remove the X belt presser ❶.

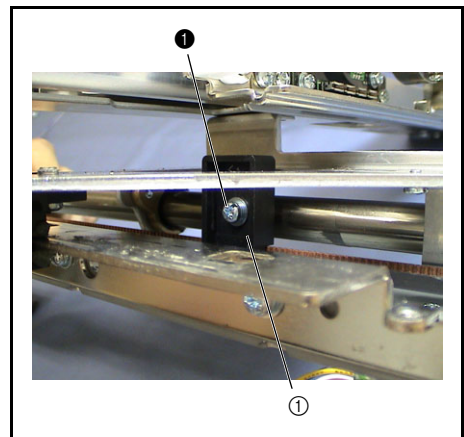

## 17 XY carriage unit removal

1. Remove the 2 screws ❶ on both ends of the X guide shaft ❶.
2. Hold both ends of the X guide shaft ❶, and rotate it toward you.
3. Lift the right end of the X guide shaft ❶ upward at an angle to remove it, and then remove the XY carriage unit ❷ from the main frame assembly ❸.
4. Pull out the X guide shaft ❶ from the Y carriage assembly ❹.

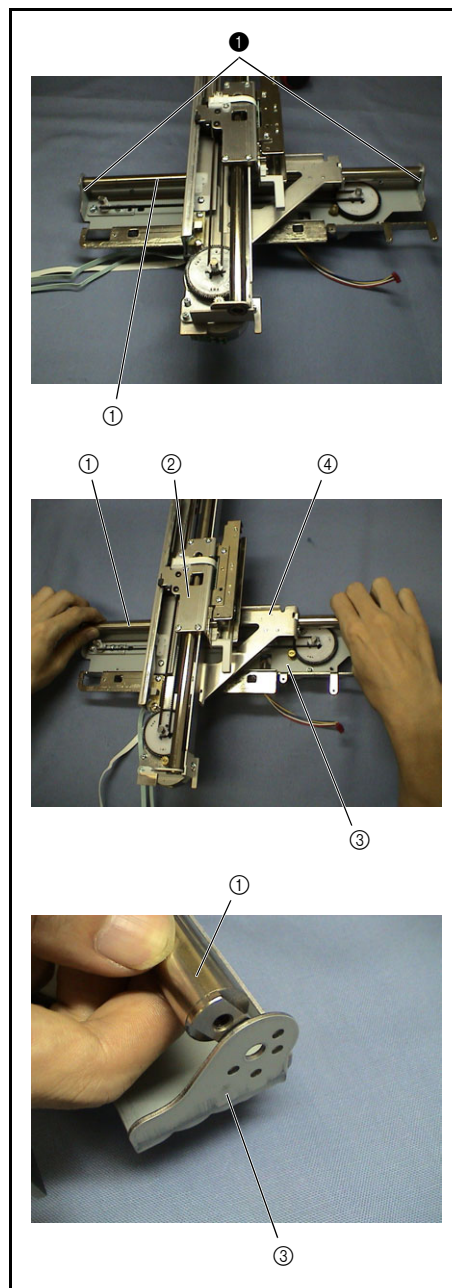

## 18 X guide plate removal

1. Remove the 3 screws ❶, and then remove the X guide plate ❶.

**\*Key point**

- Remove the coating clip.

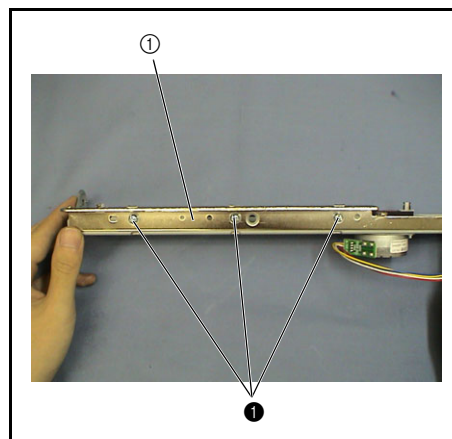

## 19 X pulse motor removal

1. Remove the 2 screws ❶, and then remove the X pulse motor assembly ❶.
2. Remove the XPM lead wire assembly ❷ from the X pulse motor.

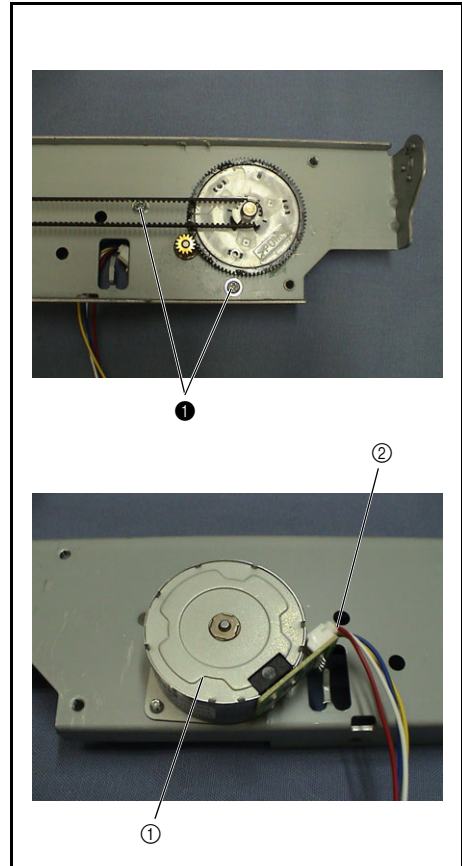

## 20 X tension pulley assembly removal

1. Remove the 2 screws ❶, and then remove the tension pulley assembly ❶.
2. Remove the timing belt (X belt) ❷.

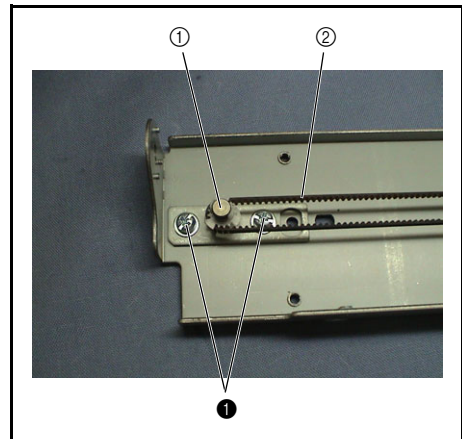

## 21 X driving gear pulley assembly removal

1. Remove the driving gear pulley assembly ❶.

### \*Key point

- Disengage the hook at the upper section of the driving gear pulley assembly.

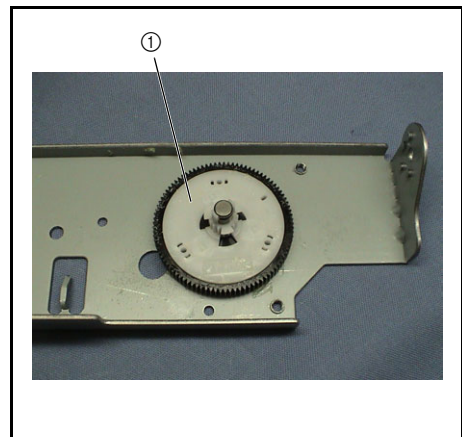

**22** X guide shaft presser removal

1. Remove the X guide shaft presser ①.
2. Remove the 2 screws ❶, and then remove the X guide shaft presser plate ②.

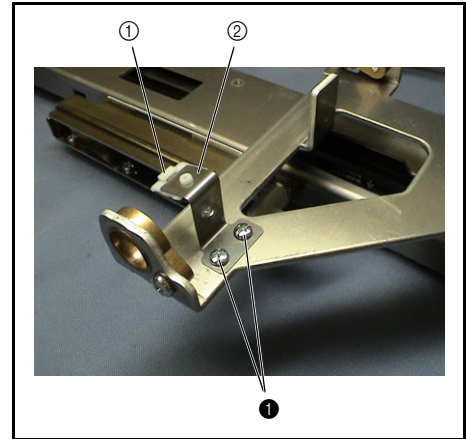
**23** X slider removal

1. Disconnect the 3 cords hanging over the guide on the X slider ①.
2. Remove the 2 screws ❶, and then remove the X slider ①.
3. Remove the 3 cords from the groove on the X slider ①.

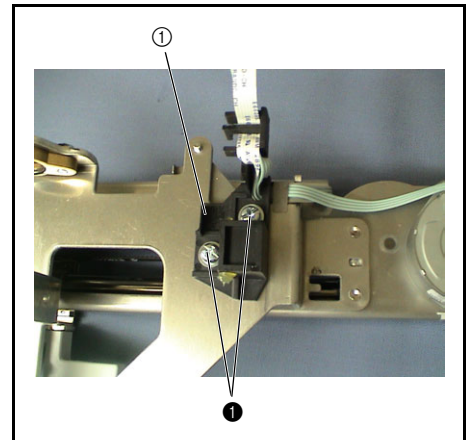
**24** Cord grip removal

1. Remove the screw ❶, and then remove the cord grip ①.
2. Remove the 3 cords from the cord grip ①.

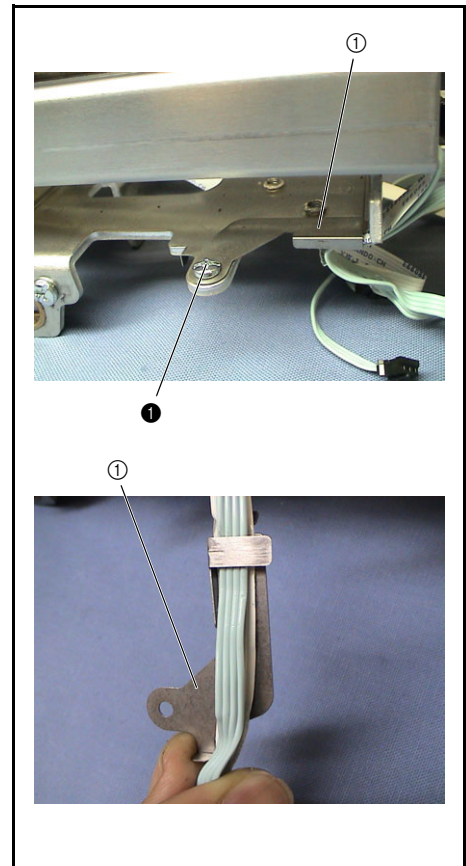



**25** YPM lead wire assembly removal

1. Remove the YPM lead wire assembly ① from the connector of the Y pulse motor ②.

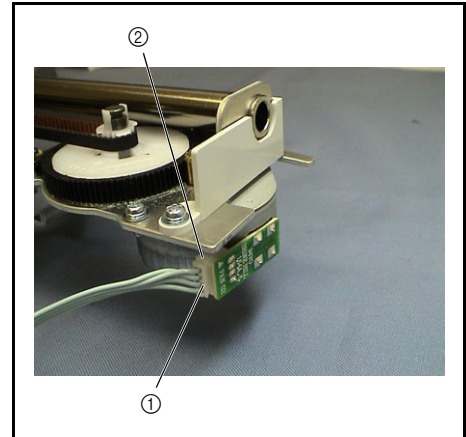
**26** Cord clip removal

1. Slide the left and right cord clips ① to the right to remove them.
2. Remove the FFC cord ② from the cord clip ① on the right.

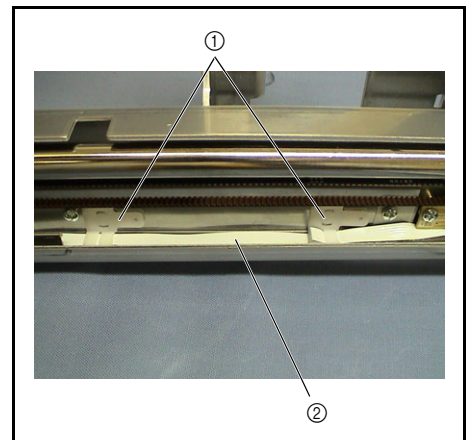
**27** Y carriage assembly removal

1. Remove the 2 screws ① from the Y carriage assembly ①.

**\*Key point**

- Do not remove the Y carriage assembly ① at this point.

2. Remove the stop ring (10.69) from the inside of the Y guide shaft ②.
3. Pull the Y guide shaft ② to the left to remove it.
4. Slide the Y carriage assembly ① to the left to remove it from the Y slider ③.
5. Remove the stop ring (10.69) from the outside of the Y guide shaft ②, and then remove the washer ④ and the spring washer ⑤ from the Y guide shaft ②.

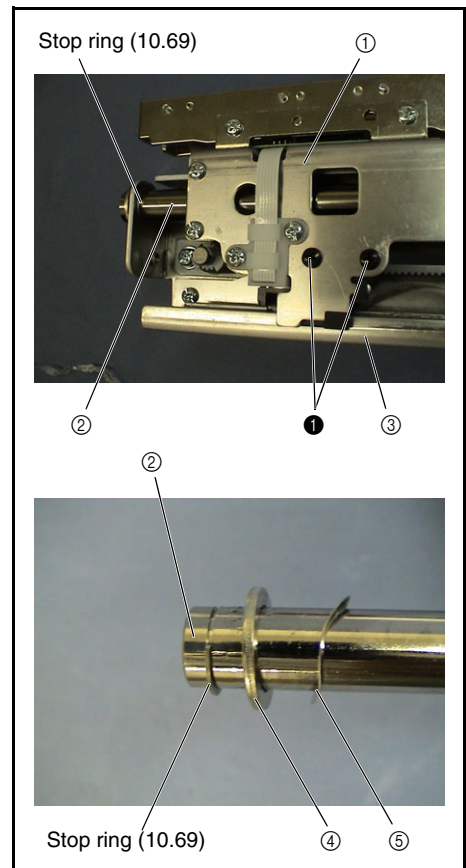

**28** FFC support assembly removal

1. Remove the 2 screws ❶, and then remove the FFC support assembly ❶.
2. Disconnect the FFC cord ❷ from the connector of the frame PCB assembly.

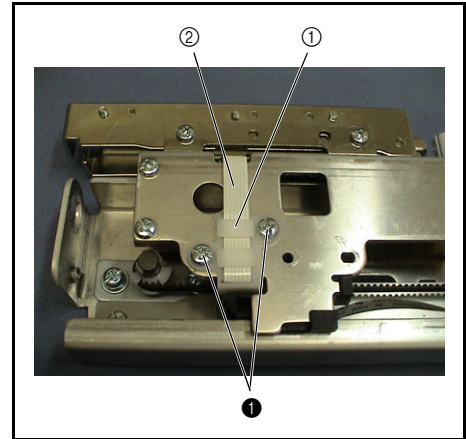
**29** FFC support ASSY disassembly

1. Remove the FFC cord ❷ from the FFC support ❶.

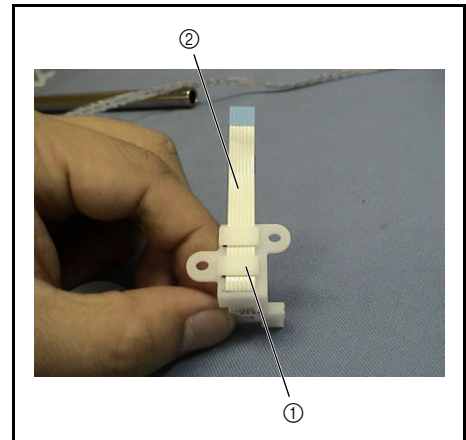
**30** E hoop presser plate assembly removal

1. Remove the 2 screws ❶, and then remove the E hoop presser plate assembly ❶.

**\*Key point**

- Remove the E hoop presser plate assembly from the bottom.

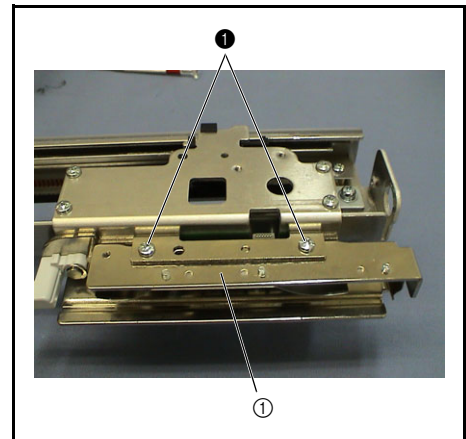
**31** E hoop stay plate assembly removal

1. Remove the 2 screws ❶, and then remove the E hoop stay plate assembly ❶.

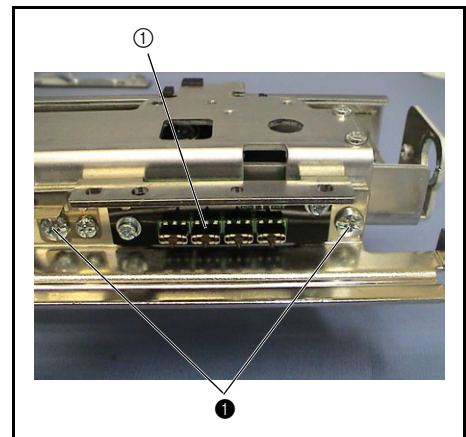



**32** E hoop stay plate ASSY disassembly

1. Remove the 2 screws ❶, and then remove the E hoop presser spring A ❶.
2. Remove the screw ❷, and then remove the E hoop presser spring C ❷.

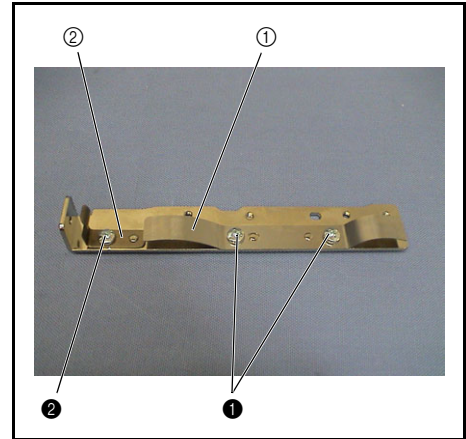
**33** E hoop stay plate ASSY disassembly

1. Remove the screw ❶, and then remove the E hoop lock lever spring ❶.
2. Remove the retaining ring (E4), and then remove the E hoop lock lever ❷.
3. Remove the 2 screws ❸, and then remove the frame PCB assembly ❸ and the insulation sheet ❹.

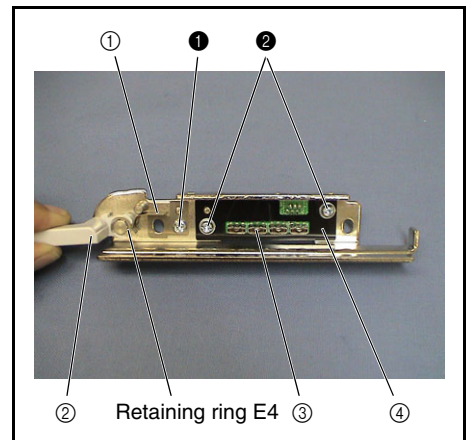
**34** XC sub cover removal

1. Remove the screw ❶, and then remove the XC sub cover ❶.

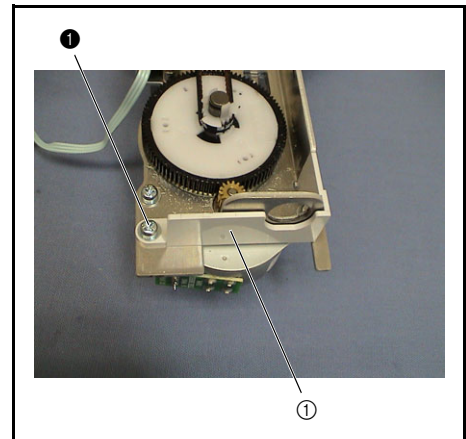
**35** Y pulse motor removal

1. Remove the 2 screws ❶, and then remove the Y pulse motor assembly ❶.

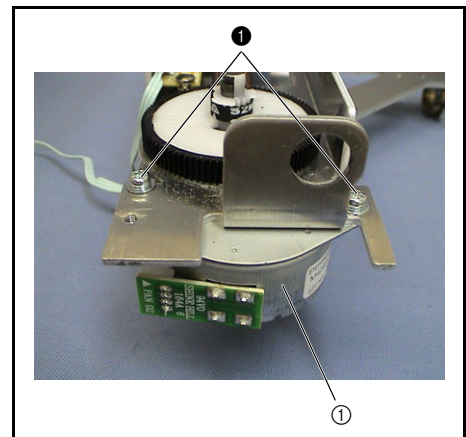

**36** Y tension pulley assembly removal

1. Remove the 2 screws ❶, and then remove the tension pulley assembly ❶.
2. Remove the timing belt (Y belt ) ❷.

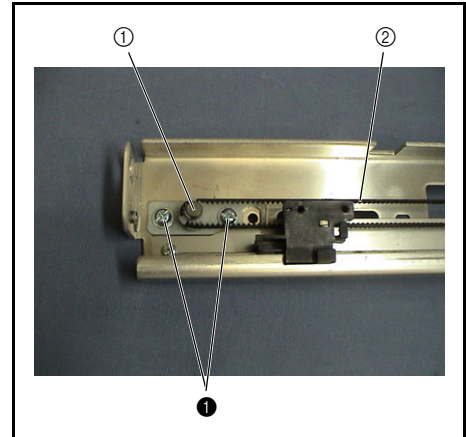
**37** Y slider assembly removal

1. Remove the screw ❶, and then remove the YT belt presser plate ❶ and the timing belt (Y belt) ❷ from the Y slider ❸.

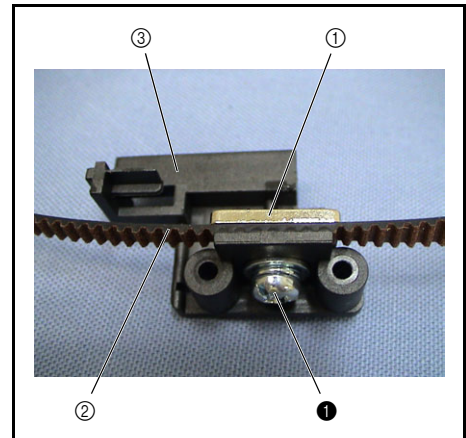
**38** Y driving gear pulley assembly removal

1. Remove the driving gear pulley assembly ❶.

**\*Key point**

- Disengage the hook at the upper section of the driving gear pulley assembly ❶.

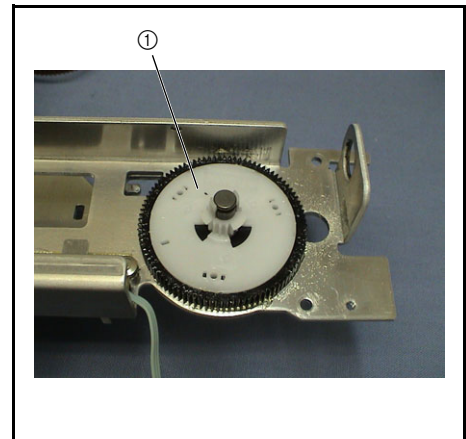
**39** FFC cord guide removal

1. Remove the 3 screws ❶, and then remove the FFC cord guide ❶ and the FFC cord supporter ❷.

**\*Key point**

- The FFC cord supporter ❷ is secured to the screw on the right.

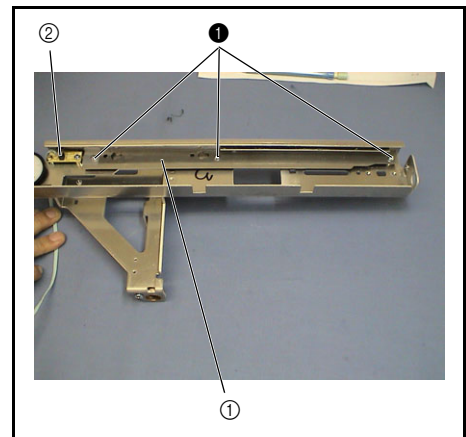

**40** Y sensor PCB assembly removal

1. Remove the screw ❶, and then remove the Y sensor PCB assembly ❶.

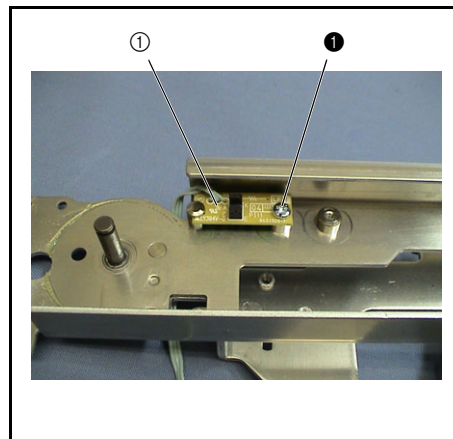

# 3 Assembly

---

Main unit	Needle-presser unit, needle threader unit, upper shaft unit.....	3 - 2
	Rotary hook driving unit, feed/rotary hook unit, thread cutter unit, side feed unit ....	3 - 8
	Bobbin winder unit.....	3 - 14
	Thread tension unit.....	3 - 22
	Power unit, motor unit.....	3 - 34
	Main parts.....	3 - 40
Module	Thread cutter module .....	3 - 56
	Side feed module.....	3 - 63
	Feed/rotary hook module.....	3 - 66
	Needle-presser module .....	3 - 91
Embroidery	Main parts .....	3 - 123

Needle-presser unit, needle threader unit, upper shaft unit location diagram

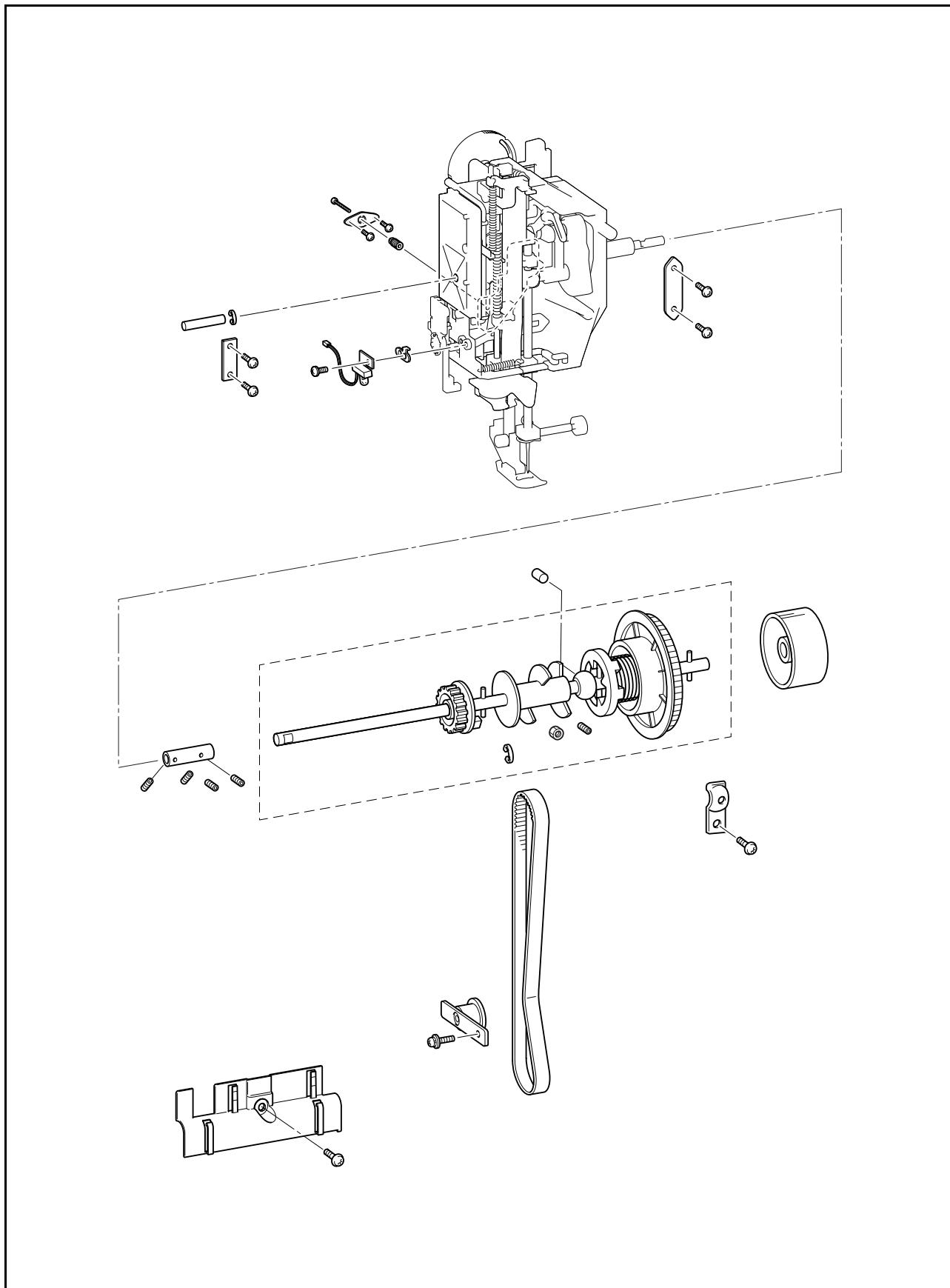

**1** Plate spring attachment

1. Attach the plate spring ① to the arm bed with the 2 screws ❶.

❶		Screw, Blind M4X5	Torque 1.18 – 1.57 N·m
---	---	----------------------	---------------------------

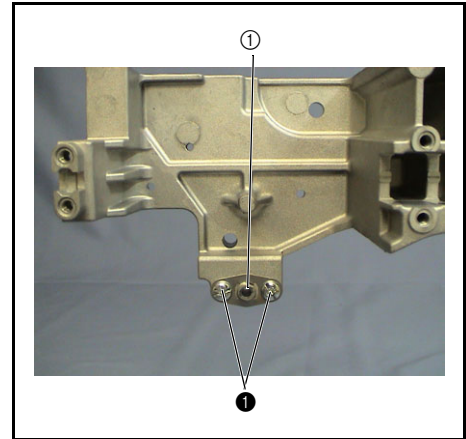



## 2 Needle-presser module attachment

1. Attach the retaining ring (E5) to the shaft ①.
2. Insert the shaft ① into the shaft hole on the needle-presser module (left side).

### \*Key point

- Insert the shorter end of the shaft from the retaining ring (E5) into the shaft hole on the needle-presser module.

3. Attach the needle-presser module to the arm bed.

### \*Key point

- Insert the tab ③ of the arm bed into the reference hole ② on the rear of needle-presser module.

4. Apply 1 or 2 drops of FBK OIL RO 100 to the oiling ports (2 locations) of the shaft bushing.
5. Temporarily tighten the screw ① to the rear of unit and adjust clearance between needle and rotary hook point. Then fully tighten the screw ①.

### \*Key point

- Refer to "Clearance between needle and rotary hook point adjustment" on page 4 - 11 for the adjustment procedure.

6. Attach the presser plate B ④ and the adjust plate A ⑤ to the shaft bushing ③ of the arm bed with the 2 screws ②.
7. Attach the presser plate A ⑥ to the arm bed with the 2 screws ②.

### \*Key point

- Move the shaft ① to the right and then tighten the 2 screws ②.
- Refer to "Needle-presser module" on page 3 - 91 for the assembly procedure.

Apply FBK OIL RO 100 to the oiling ports (2 locations) of the shaft bushing	1 - 2 drops XC8388***
---	--------------------------

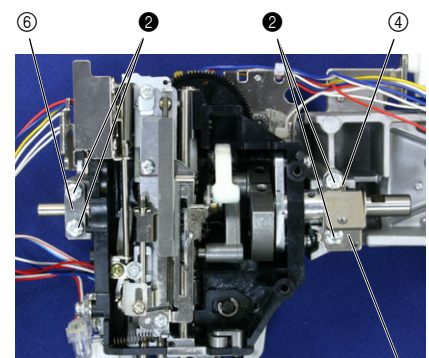
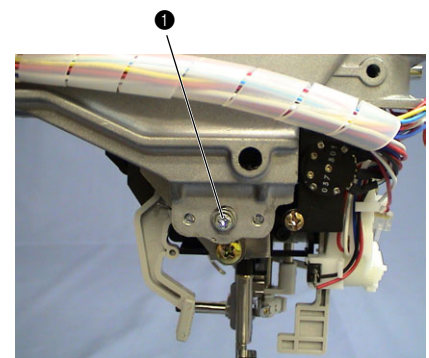
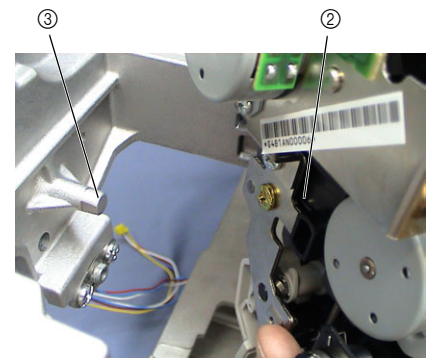
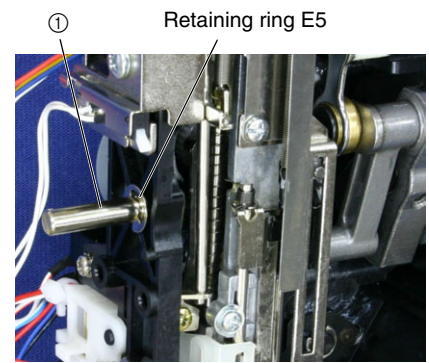

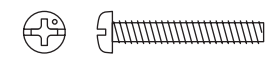
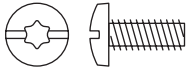
①		Screw, Pan M3X20	Torque 0.78 – 1.18 N·m
②		Tapite, Bind S M4X10	Torque 1.47 – 1.98 N·m

### 3 Upper shaft assembly attachment

1. Apply 1 or 2 drops of FBK OIL RO 100 to the upper shaft bushing attachment section ①, and then move the upper shaft bushing ② to the lubricated section.
2. Insert the fixed joint ③ into the upper shaft assembly ④.

**\*Key point**

- Be careful of the direction of fixed joint when inserting.

3. Attach the upper shaft assembly ⑤ to the arm bed.

**\*Key point**

- Place the encoder ⑦ of the upper shaft assembly on the left side of the arm rib ⑧.
- Place the upper shaft bushing ② of the upper shaft assembly on the upper shaft bushing attachment section of the arm bed.

4. Attach bushing presser A ⑨ to the upper shaft bushing attachment section of the arm bed with the screw ①.

Apply FBK OIL RO 100 to the upper shaft bushing attachment section.
---

1 - 2 drops XC8388***
--------------------------

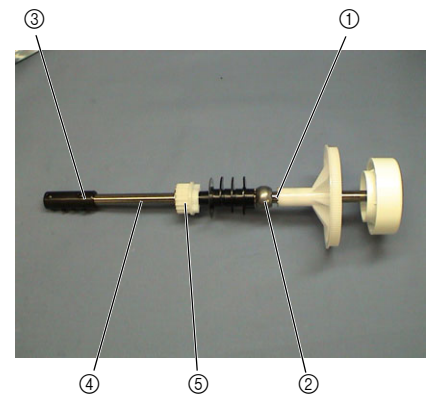

Screw holes toward the left side

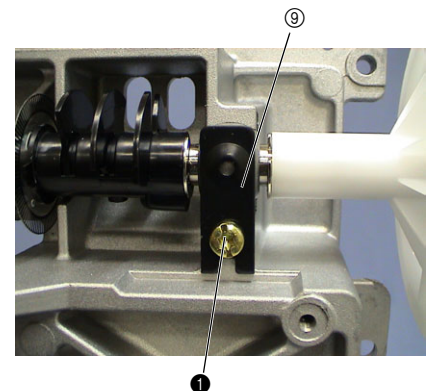
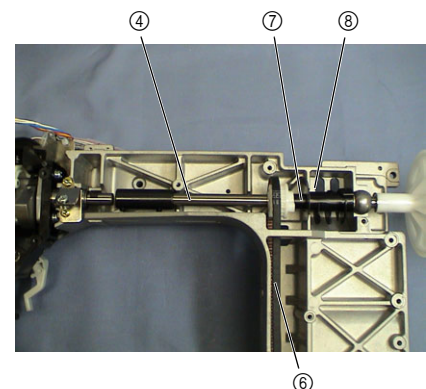

		Taprite, Bind S M4X10	Torque 1.47 – 1.98 N·m
--	--	--------------------------	---------------------------

#### 4 Needle-presser module and upper shaft assembly connection

1. Face the shaft D-cut ① of the needle-presser module and the upper shaft D-cut ② to the front.
2. Slide the fixed joint ③ to the left, and then insert it into the shaft ① of the needle-presser module.
3. Align the 2 screw holes on the fixed joint ③ with the D-cut face, and tighten the screw ① in the left screw hole by hand.

##### \*Key point

- Move the fixed joint to the left to adjust the clearance between the retaining ring ④ on the needle-presser module side and the fixed joint to 0.5 mm.
4. Move the upper shaft assembly to the left, and tighten the screw ① in the right screw hole on the fixed joint ③ by hand.
  5. Fully tighten the 2 screws ① on the fixed joint ③.
  6. Rotate the upper shaft half a turn, and tighten the 2 screws ② in the 2 screw holes on the fixed joint ③.

##### \*Key point



- Tighten the screws ② in the following order: ②-2 and then ②-1.
- Be sure to tighten the 2 screws ② after fully tightening the 2 screws ① on the fixed joint.
- If the needle-presser module and the upper shaft assembly are assembly properly, the base line ⑥ of the pulley ⑤ is positioned at the top.

##### NOTE

Check the upper shaft rotation torque before the timing belt is attached.

If the rotation torque is heavy, perform the following adjustment.

- Drop a brass bar of approx. 1 kg from a height of 50 mm onto the oil hole on bushing presser A.
- Tighten the screw, and apply 1 or 2 drops of FBK OIL RO 100 to the oil hole on bushing presser A.

①		Set Screw, Socket (FT) M5X5	Torque 1.37 – 1.79 N·m
②		Set Screw, Socket (CP) M4X4	Torque 0.78 – 1.18 N·m

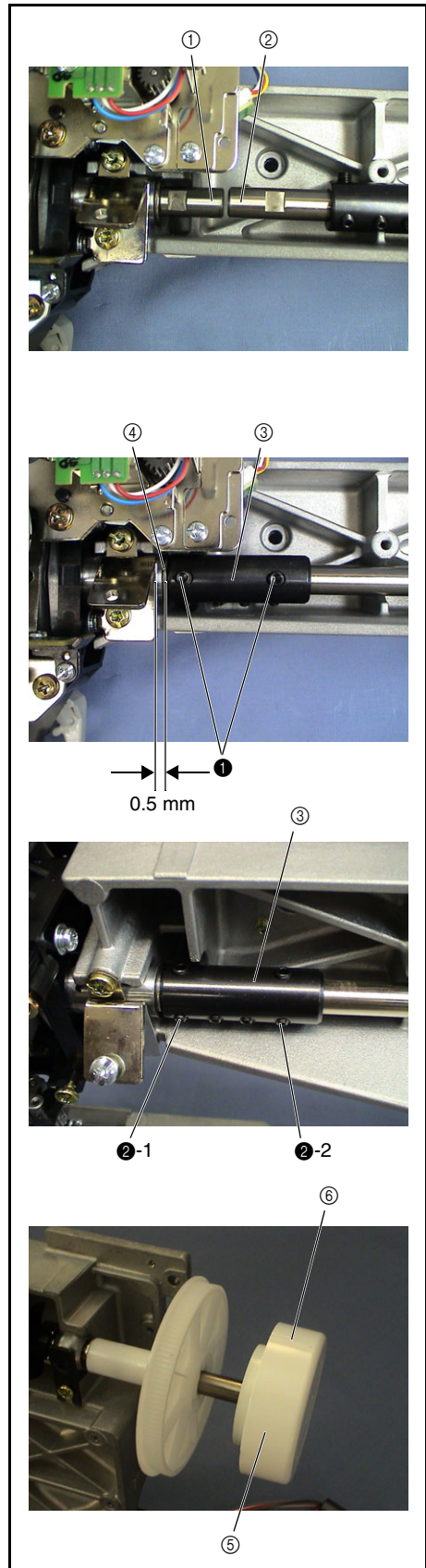

**5** Upper shaft cover attachment

1. Attach the upper shaft cover ① to the arm bed with the screw ❶.

❶		Screw, Bind M4X6	Torque 0.79 – 1.18 N·m
---	---	---------------------	---------------------------

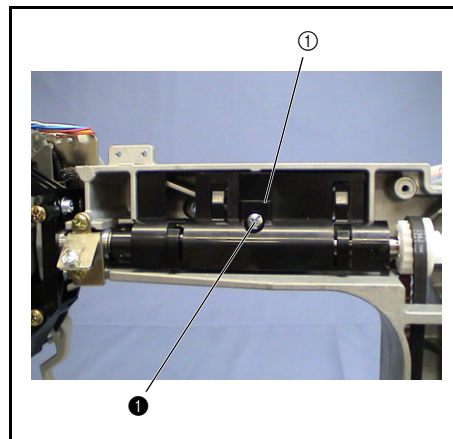

Rotary hook driving unit, feed/rotary hook unit, thread cutter unit, side feed unit location diagram

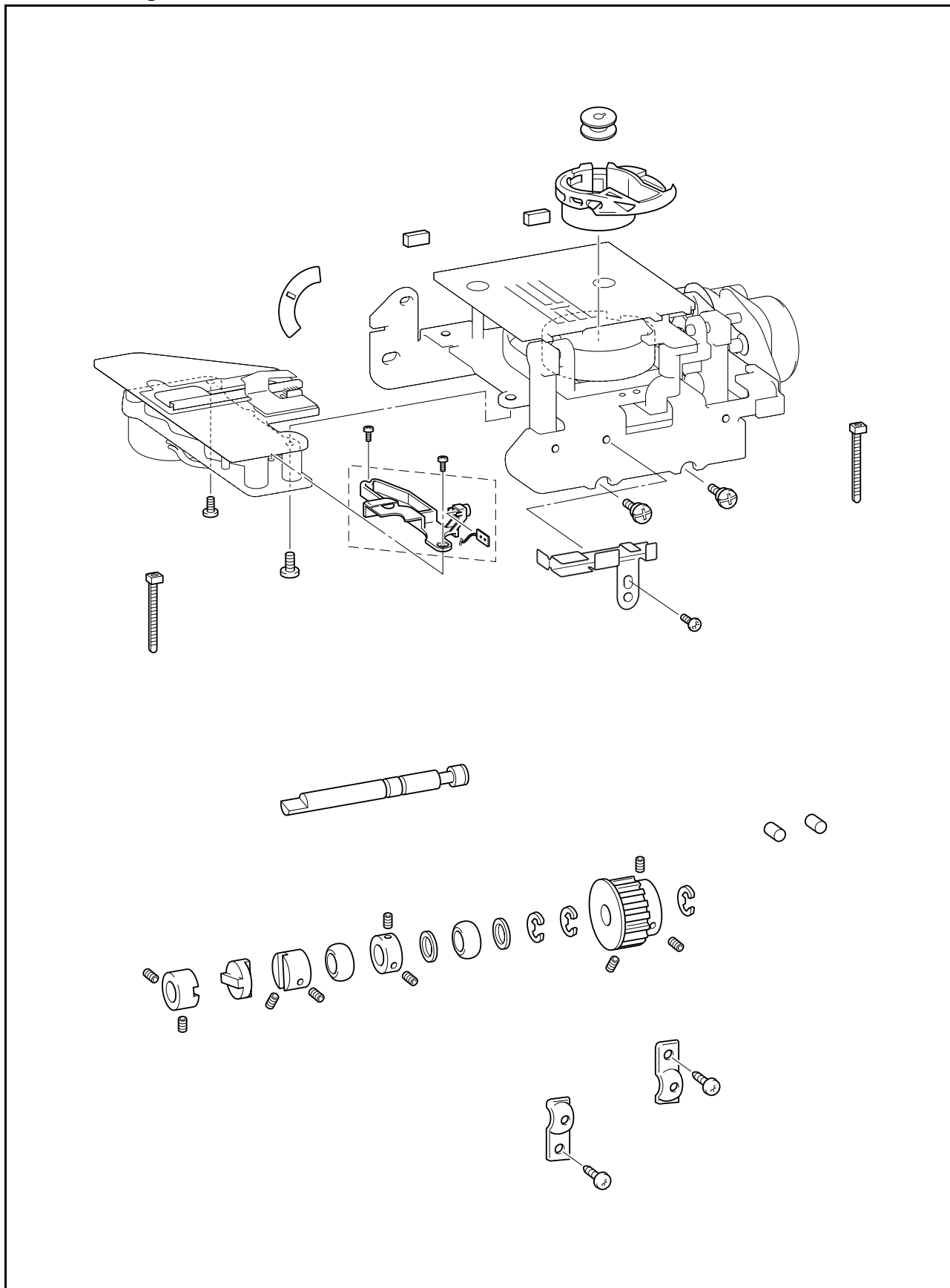



## 1 Lower shaft A assembly attachment

1. Rotate the pulley (upper shaft) ① until the base line ② of the pulley comes to the top.
2. Apply 1 or 2 drops of FBK OIL RO 100 to the lower shaft bushing attachment sections ③ (2 locations), and then move the lower shaft bushing ④ to the lubricated section.
3. Hang the timing belt ⑥ over the timing pulley D ⑤ of the lower shaft A assembly.
4. Set the lower shaft bushing ④ to the arm bed's lower shaft bushing attachment sections (2 locations).
5. Place the bushing pressers ⑦ on the lower shaft bushings ④ (one each at 2 locations).
6. Secure the bushing pressers ⑦ with the screw ⑧ (2 locations).

### \*Key point

- Before tightening the screw ⑧, check that the slit on the joint ⑧ is vertical and the screw hole ⑨ faces the front.

Apply FBK OIL RO 100 to the lower shaft's lower shaft bushing attachment sections (2 locations)
---

1 - 2 drops XC8388***
--------------------------

### NOTE

Check the lower shaft rotation torque.

If the rotation torque is heavy, perform the following adjustment.

- Drop a brass bar of approx. 1 kg from a height of 50 mm onto the oil hole on the bushing presser.
- Tighten the screw, and apply 1 or 2 drops of FBK OIL RO 100 to the oil hole on the bushing presser.

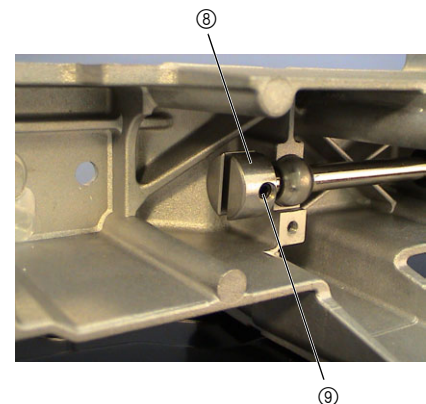
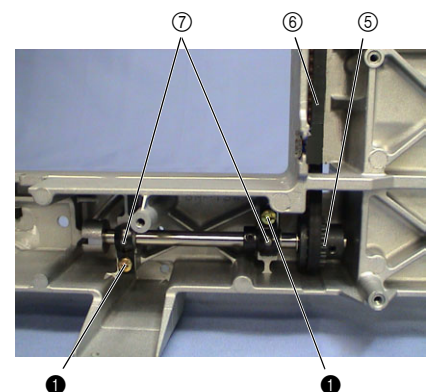
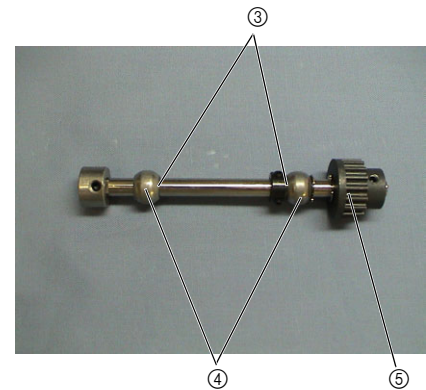
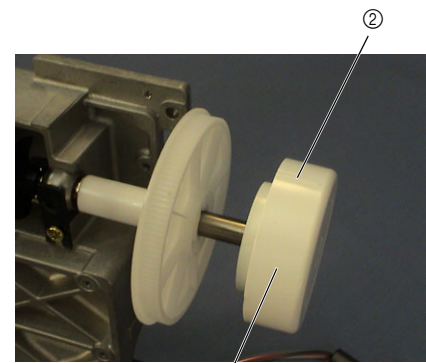

⑧		Taprite, Bind S M4X10	Torque 1.47 – 1.96 N·m
---	--	--------------------------	---------------------------



## 2 Tension pulley assembly attachment

- Temporarily secure the tension pulley assembly ① to the arm bed with the screw ❶.  
Adjust the timing belt tension, and then fully tighten the screw ❶.

### \*Key point

- Refer to "Timing belt tension adjustment" on page 4 - 3 for the adjustment procedure.

❶		Screw, Pan (S/P washer) M4X10DA	Torque 1.18 – 1.57 N·m
---	---	------------------------------------	---------------------------

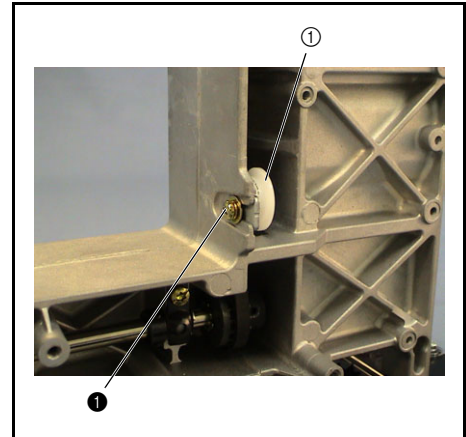

## 3 Sheet attachment

- Wipe the sheet attachment face ① of the arm bed with a cloth dampened with alcohol.
- Attach the sheet to the sheet attachment face ①.

### \*Key point

- Check that the alcohol on the sheet attachment face ① has dried before attaching the sheet.
- Hold the sheet at the ends, and attach it so that it fits snugly against the reference pin ②.

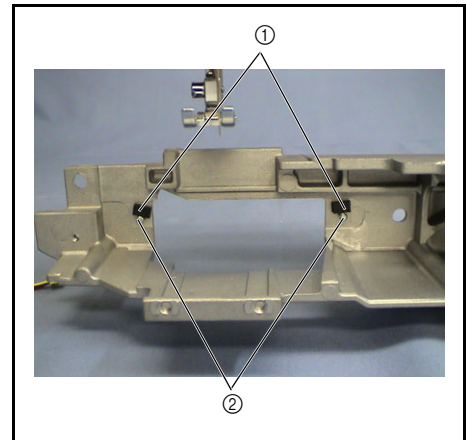

#### 4 Feed/rotary hook module attachment

1. Insert the Joint ① of the feed/rotary hook module until the D-cut of lower shaft B ②.
2. Apply a bead of EPNOC AP(N) 0 to the slit ③ on both joints of lower shaft A ⑦ and lower shaft B ②.
3. Rotate the pulley (upper shaft) until the base line of the pulley ④ comes to the top, meaning that the D-cut of lower shaft A ⑦ faces the front. Attach the disk ⑤ to the joint.
4. Attach the feed/rotary hook module with the 2 screws ②.

##### \*Key point

- Use the disk to align lower shaft A ⑦ and lower shaft B ② while the D-cut of lower shaft A ⑦ faces the front (slit on the joint is vertical) and the D-cut of lower shaft B ② face the top (slit on the joint is horizontal).
  - Lightly press the feed/rotary hook module from above, and tighten the 2 screws ②.
5. Loosen the 2 screws ① securing lower shaft A ⑦. Move the joint ⑥ to the left, and then retighten the 2 screws ①.

##### NOTE

After attaching the feed/rotary hook module, check that the following conditions are met while the base line of the pulley (upper shaft) is at the top:

- The needle bar is at the top point.
- The D-cut of lower shaft A ⑦ faces the front.
- The D-cut of lower shaft B ② is at the top.
- The reference hole on the outer rotary hook faces the front.

##### \*Key point

- Refer to "Feed/rotary hook module" on page 3 - 66 for the assembly procedure.

Apply EPNOC AP(N) 0 to the slit on both joints of lower shaft A and lower shaft B.

Bead  
XC8387\*\*\*

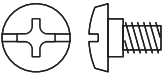
①		Set Screw, Socket (FT) M5X5	Torque 1.37 – 1.77 N·m
②		Screw M4	Torque 1.18 – 1.57 N·m

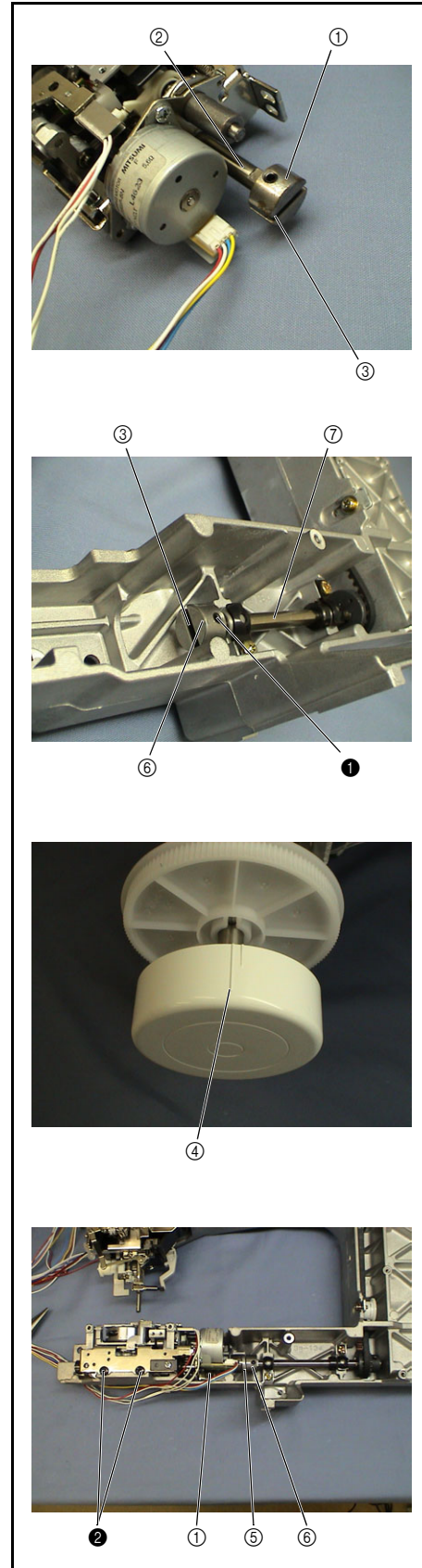



## 5 Thread cutter module attachment

1. Attach the thread cutter module to the feed/rotary hook module with the screws ① and ② on the bottom of the thread cutter module.

### \*Key point

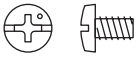
- Engage the 2 positioning tabs on the thread cutter module with the 2 positioning holes (round hole and semi-round hole) on the feed/rotary hook module.
- Refer to "Thread cutter module" on page 3 - 56 for the assembly procedure.

①		Screw, Bind M3X5	Torque 0.78 – 1.18 N·m
②		Screw, Bind M4X5	Torque 1.18 – 1.57 N·m

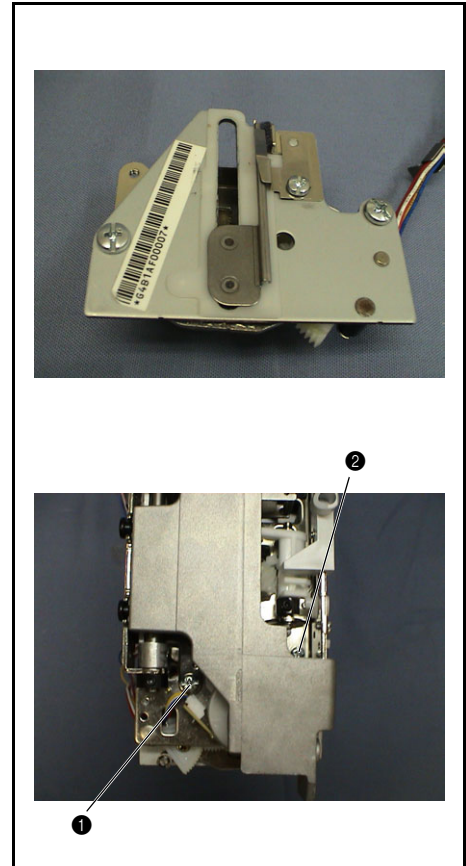

## 6 Side feed module removal attachment



1. Attach the side feed module ① to the arm bed with the 2 screws ① (CS-6 clip is secured to both screws).

### \*Key point

- Tighten the screws ① in the following order: ①-1 (temporarily tighten), ①-2 (fully tighten), and ①-1 (fully tighten).
2. Attach the side feed adjust plate ② of the side feed module to the feed bar of the feed/rotary hook module with the 2 screws ②.

### \*Key point

- Tighten the right screw ② first.
- Refer to "Front/back and left/right position of feed dog adjustment" on page 4 - 21 for the feed dog position check.
- Refer to "Side feed module" on page 3 - 63 for the assembly procedure.

①		Taprite, Bind S M4X10	Torque 1.47 – 1.96 N·m
②		Screw, Bind M3X5	Torque 0.79 – 1.18 N·m

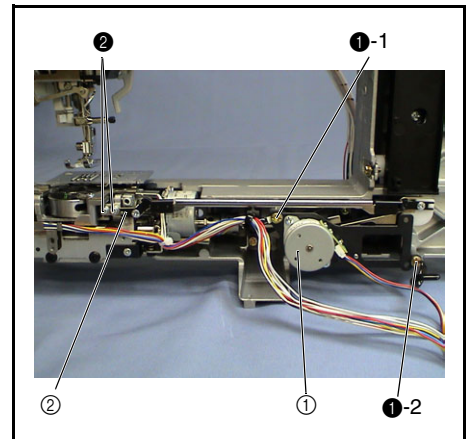

## 7 Lead wire guide holder attachment

1. Attach the lead wire guide holder ① to the feed/rotary hook module with the screw ❶.

**\*Key point**

- Engage the positioning tab on the lead wire guide holder with the positioning hole on the feed/rotary hook module.

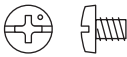
❶		Screw, Bind M3X4	Torque 0.79 – 1.18 N·m
---	---	---------------------	---------------------------

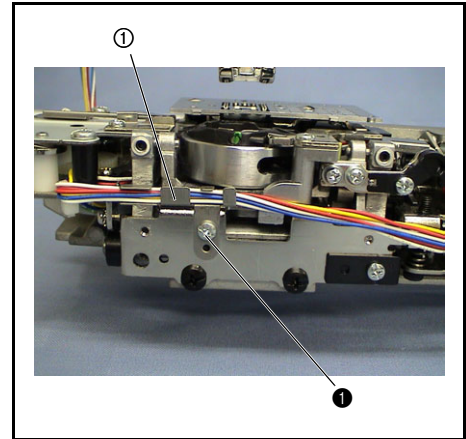

Bobbin winder unit location diagram

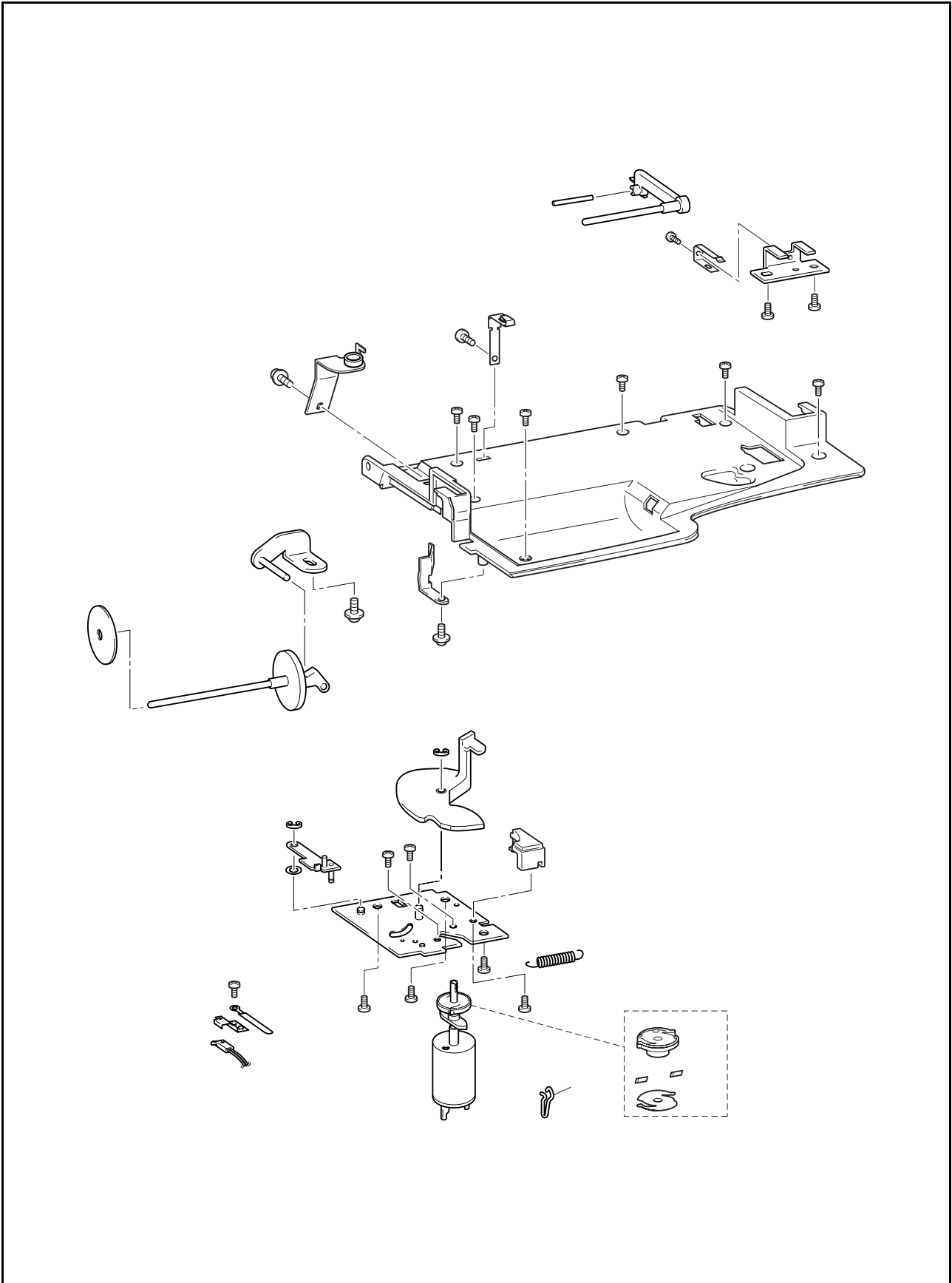

### 1 BW motor assembly attachment

1. Attach the BW motor assembly ① to the bobbin winder holder assembly ② with the 2 screws ③.

③		Screw, Bind M3X3	Torque 0.79 – 1.18 N·m
---	---	---------------------	---------------------------

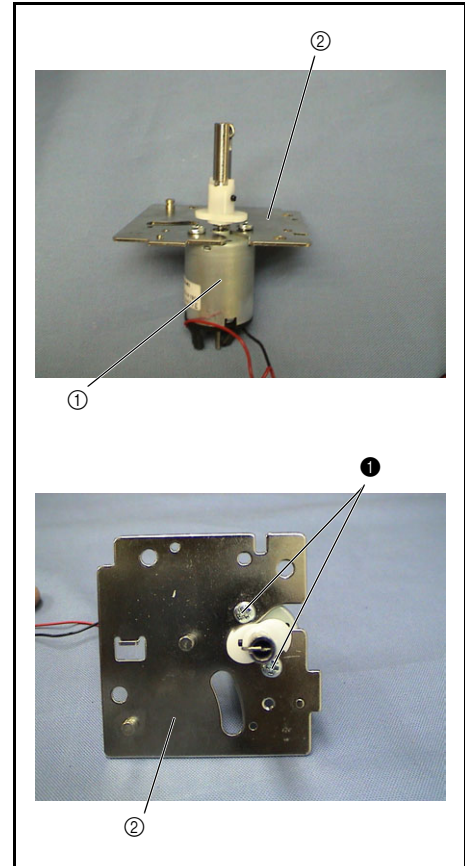

### 2 Bobbin presser attachment

1. Position the bobbin winder cam ① of the BW motor assembly laterally.
2. Place the bobbin presser ② onto the shaft of the bobbin winder holder assembly (longer shaft at the center), and attach the retaining ring (E3).

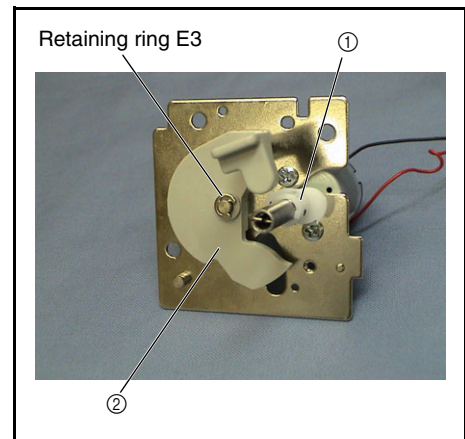

### 3 Bobbin presser guide assembly attachment

1. Place the polyester slider ① and then the bobbin presser guide ② onto the shaft of the bobbin winder holder assembly (shorter shaft on the left side), and attach the retaining ring (E3).

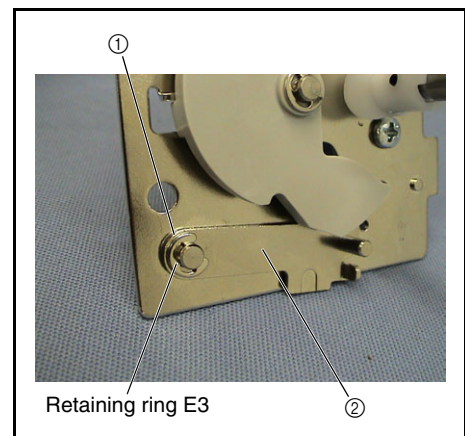



#### 4 Spring attachment

1. Reverse the bobbin winder assembly ①.
2. Attach the spring S59 to the shaft groove ② of the bobbin presser guide assembly and the notch ③ of the bobbin winder holder assembly.

**\*Key point**

- Attach the spring S59 as described below:  
Round end ⇒ Shaft groove ② of bobbin presser guide assembly  
Hook end ⇒ Notch ③ of the bobbin winder holder assembly

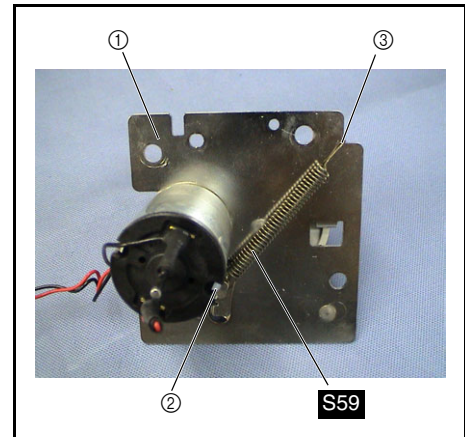
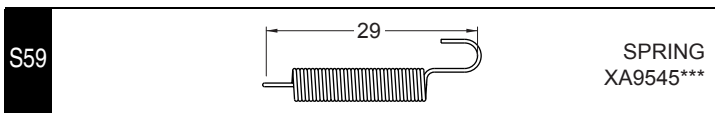

#### 5 BWSW assembly (D6) attachment

1. Attach the BWSW assembly ① and BWSW holder ②.

**\*Key point**

- Engage the positioning tab on the BWSW assembly with the positioning hole on the BWSW holder.

2. Attach the BWSW assembly (D6) ④ to the bobbin winder holder assembly ③, using the screw ① with coating clip.

**\*Key point**

- Engage the positioning tab on the bobbin winder holder assembly with the positioning hole on the BWSW assembly (D6).

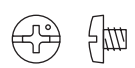
<b>1</b>		Screw, Bind M3X3	Torque 0.79 – 1.18 N·m
----------	---	---------------------	---------------------------

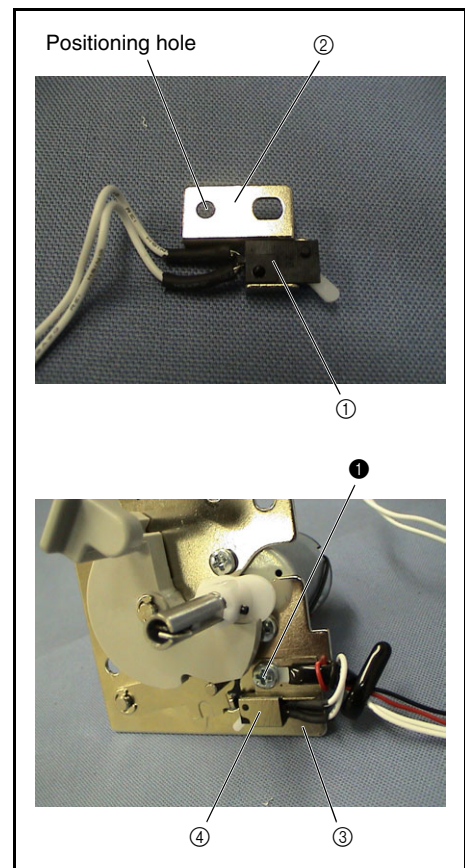

## 6 Bobbin presser cover attachment

1. Attach the bobbin presser cover ① to the bobbin winder holder assembly ② with the screw ③.

### \*Key point

- Engage the positioning tab on the bobbin presser cover with the positioning hole on the bobbin winder holder assembly.
- Tighten the screw ③ from the rear.

③		Taptite, Bind B M3X8	Torque 0.79 – 1.18 N·m
---	---	-------------------------	---------------------------

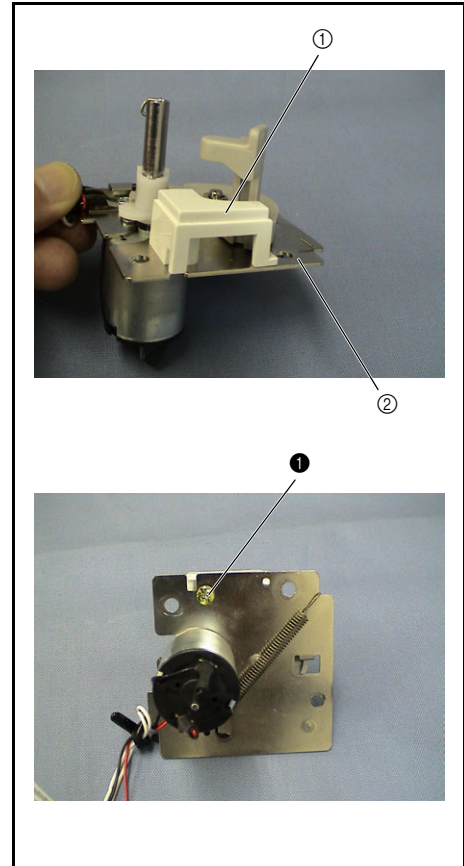

## 7 Bobbin winder assembly attachment

1. Attach the bobbin winder assembly ① to the rear of the upper cover with the 3 screws ①.

### \*Key point

- Tighten the screws ① in the following order: ①-1, ①-2, and ①-3.

2. Tie the BW motor lead wire and the BWSW lead wire with a band.

### \*Key point

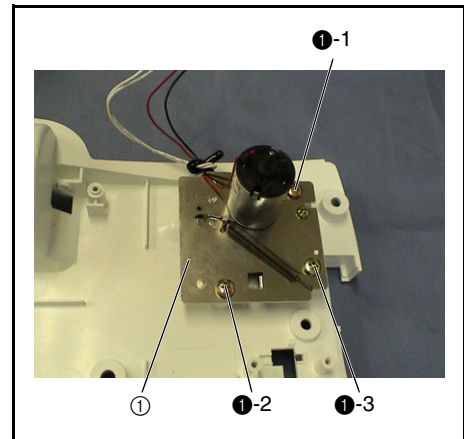

- Pass the BW motor lead wire over the motor.
- Place the band in the groove on the bobbin presser guide cover. Remove any slack from the lead wires and tie them.

①		Taptite, Bind B M4X10	Torque 0.79 – 1.18 N·m
---	---	--------------------------	---------------------------



## 8 Spool pin attachment

1. Place the shaft hole on the spool pin ① on the rear of the upper cover.
2. Insert the shaft of spool pin holder assembly B ② into the hole on the spool pin ①.
3. Attach the spool pin holder assembly B ② with the screw ①.

①			Taptite, Cup B M3X8	Torque 0.59 – 0.79 N·m
---	---	---	------------------------	---------------------------

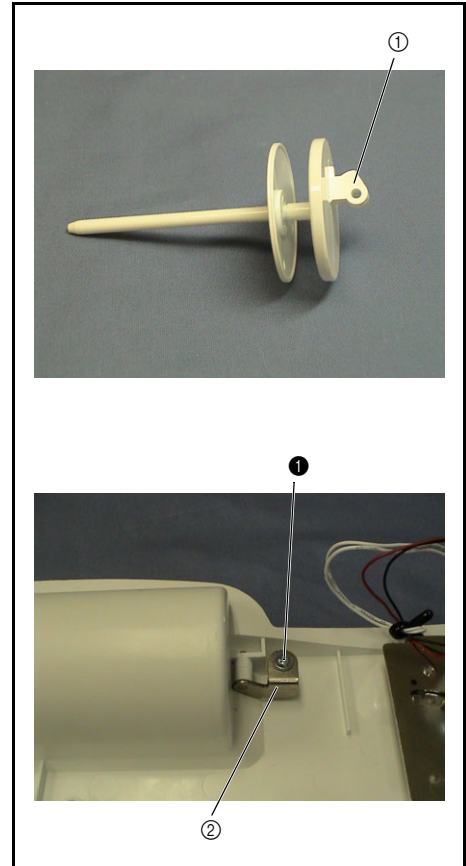

## 9 Sub spool stand pin attachment

1. Attach the plate spring ① to the sub spool pin holder ② with the screw ①.



### \*Key point

- Engage the positioning tab on the sub spool pin holder ② with the positioning hole on the plate spring ①.

2. Place the shaft hole on the sub spool pin holder ③ on the rear of the upper cover.
3. Insert the shaft ④ into the hole on the sub spool pin holder ③ from the rear of the upper cover, and attach these to the bushing.
4. Attach the sub spool pin holder assembly ④ with the 2 screws ②.

### \*Key point

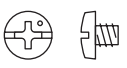
- Tighten the screws ② in the following order: ②-1 (temporarily tighten), ②-2 (fully tighten), and ②-1 (fully tighten).

①		Screw, Bind M3X3	Torque 0.79 – 1.18 N·m
②		Tapite, Bind B M3X8	Torque 0.59 – 0.79 N·m

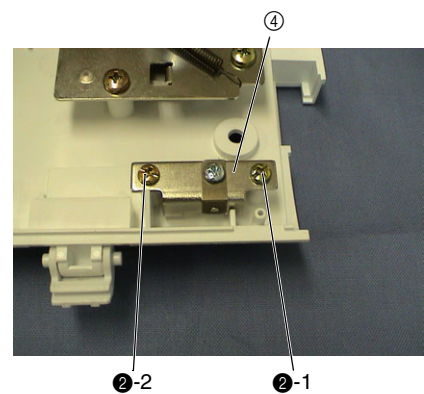
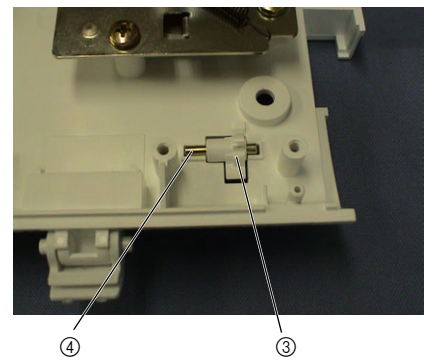
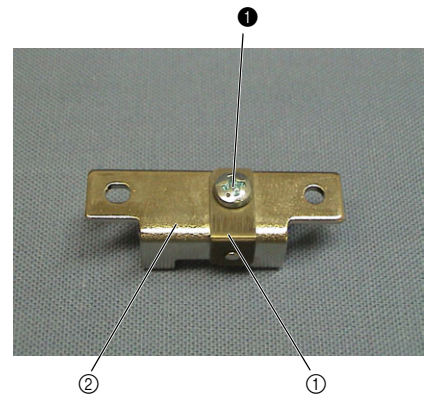
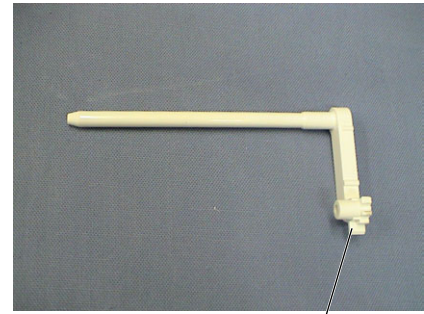

## 10 Thread guard plate attachment

1. Insert the thread guard plate ① into the groove on the side face of the upper cover.
2. Attach the thread guard plate ① with the screw ❶.

### \*Key point

- Tighten the screw ❶ from the rear of the upper cover.

❶		Taptite, Cup B M3X8	Torque 0.59 – 0.79 N·m
---	---	------------------------	---------------------------

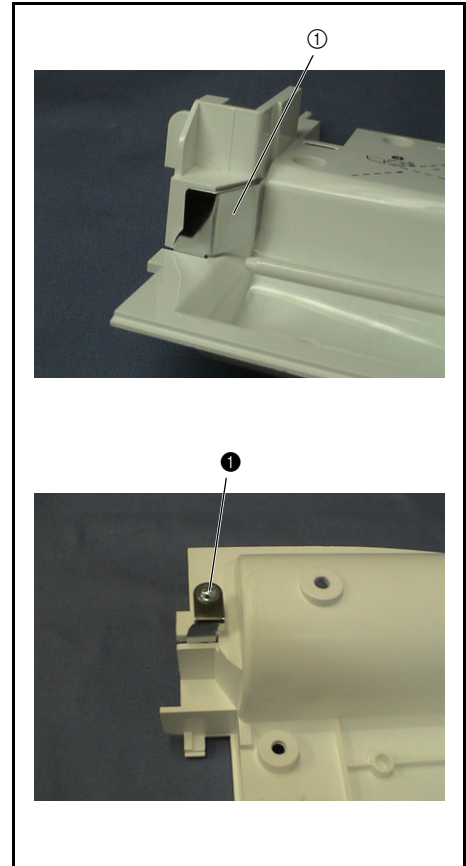

## 11 Thread guide plate attachment

1. Insert the thread guide plate ① into the groove on the top face of the upper cover.
2. Attach the thread guide plate ① with the screw ❶.

### \*Key point

- Tighten the screw ❶ from the rear of the upper cover.

❶		Taptite, Bind B M3X8	Torque 0.59 – 0.79 N·m
---	---	-------------------------	---------------------------

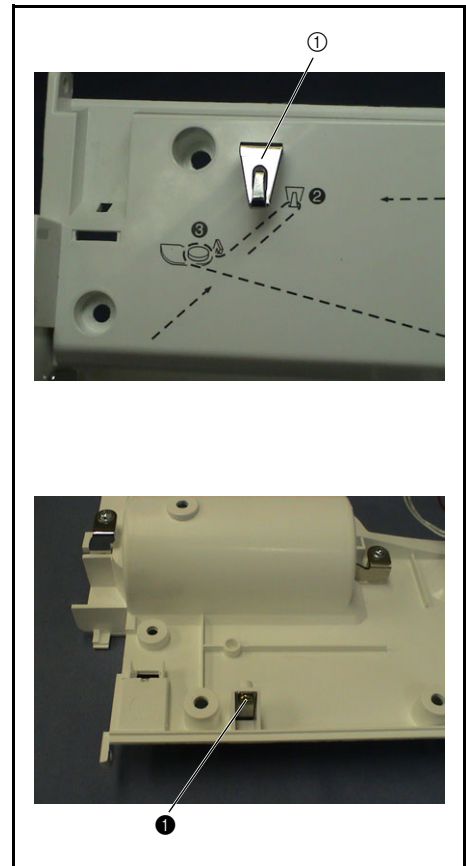



## 12 Bobbin base assembly attachment

- Place the bobbin base assembly ① onto the bobbin winder shaft assembly ②, and push it until you hear a click.

### \*Key point

- Engage the tab on the bobbin winder shaft assembly ② with the notch on the bobbin base assembly ①.

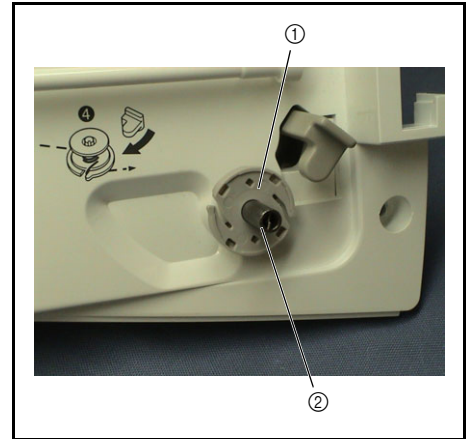

## 13 Tension guide assembly attachment

- Insert the tension guide assembly ① into the groove on the top face of the upper cover.
- Attach the tension guide assembly ① with the screw ①.

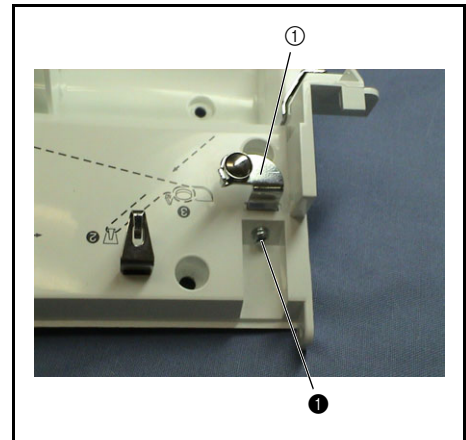

①		Screw, Pan (SIP washer) M3X8DA	Torque 0.59 – 0.79 N·m
---	---	-----------------------------------	---------------------------



### Thread tension unit location diagram

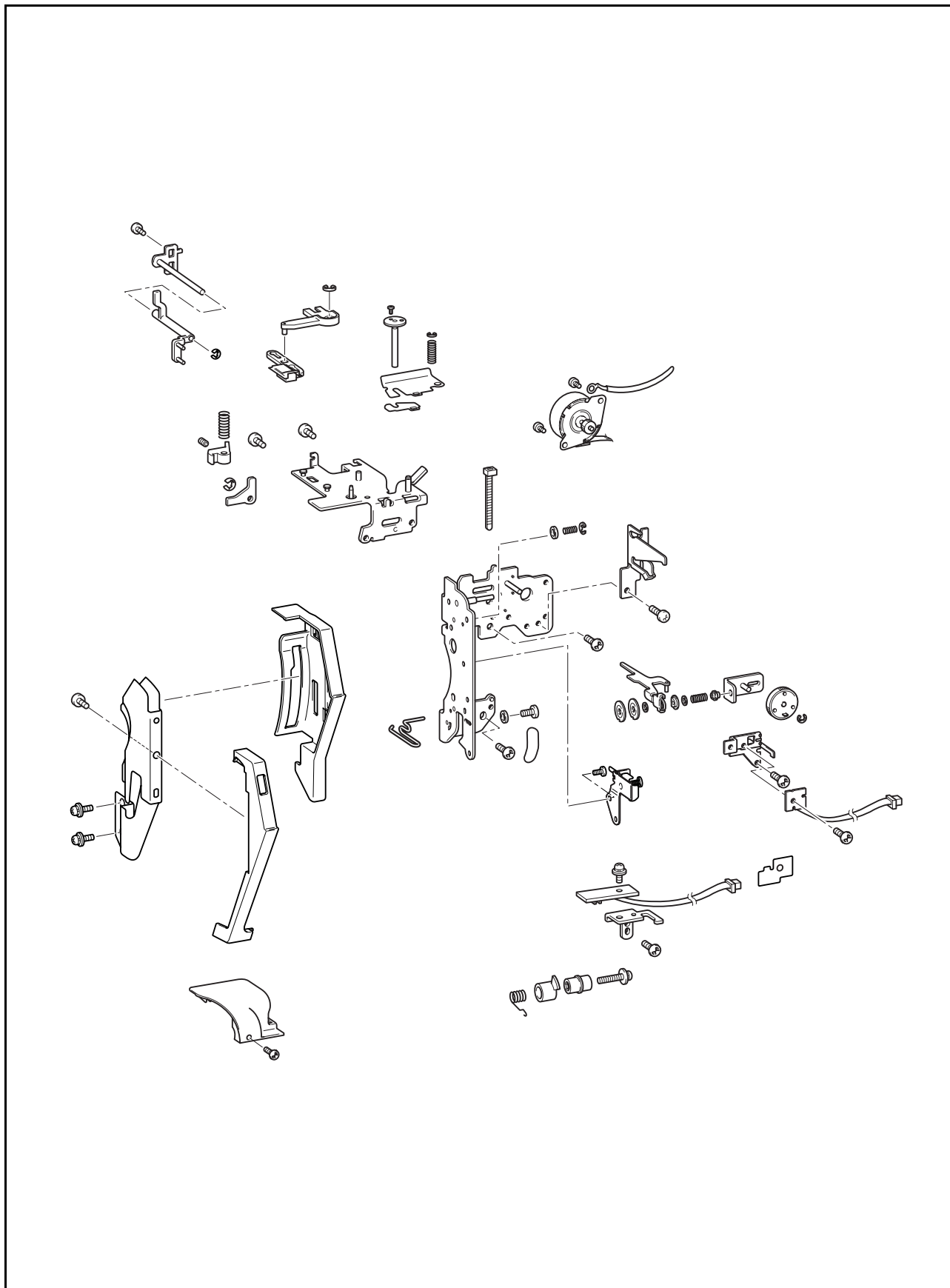

## 1 Spring tape attachment

1. Attach the spring tape ① along the R-section of the thread guard.

### \*Key point

- Do not allow the spring tape ① to protrude from the thread guard.

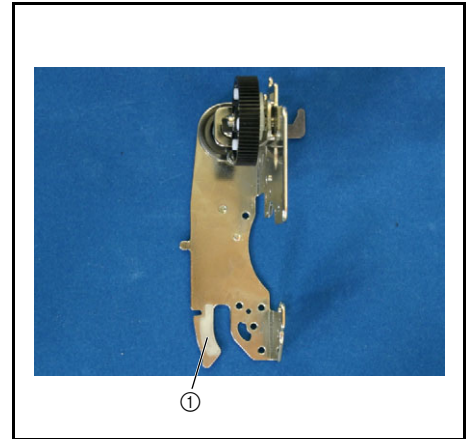

## 2 Thread guide wire attachment

1. Insert the hook of the thread guide wire ① into the hole on the thread guard.
2. Insert the plain washer ② between the thread guide wire ① and the thread guard ③.
3. Attach the thread guide wire ① to the thread guard ③ with the screw ④.

### \*Key point

- Move the thread guide wire ① upward, and then attach it.

④		Screw, Bind M3X4	Torque 0.78 – 1.18 N·m
---	--	---------------------	---------------------------

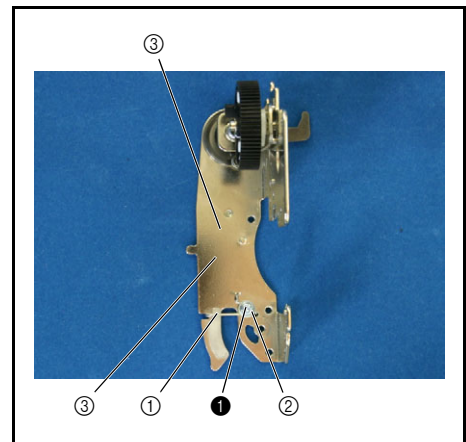

### 3 Thread take up spring ASSY assembly

1. Apply a light covering of silicon grease to the outer and inner peripheries of the spring **S11**.
2. Insert the thread cutting shutter **②** into the thread catching spring case **①**.
3. Insert the spring **S11** from the bottom of the thread catching spring case **①**.

**\*Key point**

- Insert the straight section of the spring **S11** to the middle hole (when viewed from the top) of the 3 thread take up spring tension positioning holes.

4. Insert the L-shape section of the spring **S11** to the spring groove of the thread cutting shutter **②**.

**\*Key point**

- Position the spring groove of the thread cutter shutter **②** between two tabs on the bottom of the thread catching spring case **①**.

Apply silicon grease to the outer and inner peripheries of the spring **S11**.

Light covering

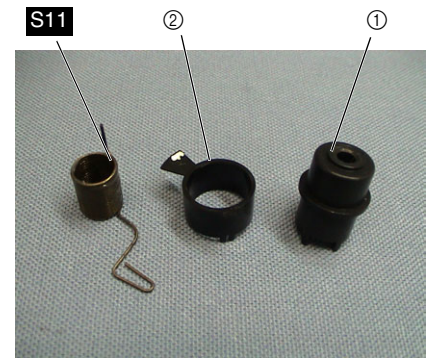

S11

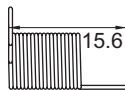

THREAD TAKE UP SPRING  
XZ0386\*\*\*

### 4 Thread take up spring assembly attachment

1. Attach the thread take up spring assembly **①** to the thread guard **②** with the screw **①**.

**\*Key point**

- Engage the 2 tabs on the bottom of the thread catching spring case with the slots on the thread guard **②**, and slide the tabs clockwise.
- Check that the thread take up spring **③** contacts the spring tape **④**.

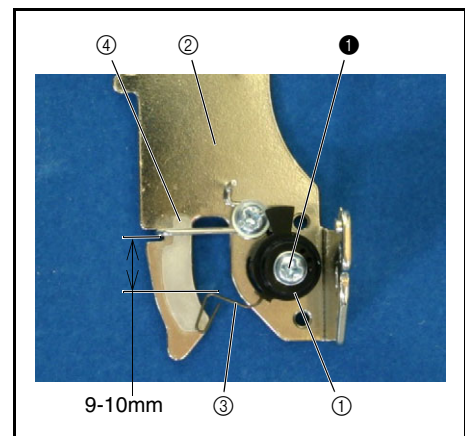

## 5 Thread tension gear assembly attachment

- Place the tension disk A ② and the tension disk B ③ onto the thread tension disk shaft ① of the thread guard.
- Place the plain washer (S3) ⑤ and the spring S02 onto the calking pin ④ of the thread guard, and then attach the retaining ring (E2).

### \*Key point

- Use the plain washer (S3) ⑤ to hold the tension disk A ② and the tension disk B ③.

- Place the washer ⑥, thread tension plate assembly ⑦, tension disk washer ⑧, washer ⑥ and spring S05, and tension adjusting screw ⑨ onto the thread tension disk shaft ① of the thread guard.
- Place the thread plate assembly ⑩ onto the thread tension disk shaft ①, and then thread the tension adjusting screw ⑨ to the thread plate assembly ⑩.

### \*Key point

- Compress the spring S05 to place the thread plate assembly ⑩.

- Apply a light covering of EPNOC AP(N) 0 to the entire surface of the calking pin ⑪ of the thread guard.
- Apply a light covering of EPNOC AP(N) 0 to the entire rear surface of the thread tension gear assembly ⑫.
- Place the thread tension gear assembly ⑫ onto the calking pin ⑪ of the thread guard, and then attach the retaining ring (E3).

Apply EPNOC AP(N) 0 to the entire surface of the calking pin of the thread guard (attachment shaft of the thread tension gear assembly)

Light covering  
XC8387\*\*\*

Apply EPNOC AP(N) 0 to the entire rear surface of the thread tension gear assembly.

Light covering  
XC8387\*\*\*

S02



SPRING  
X57605\*\*\*

S05



THREAD TENSION SPRING  
XA9900\*\*\*

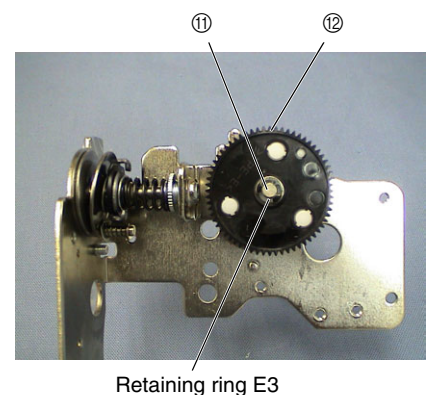
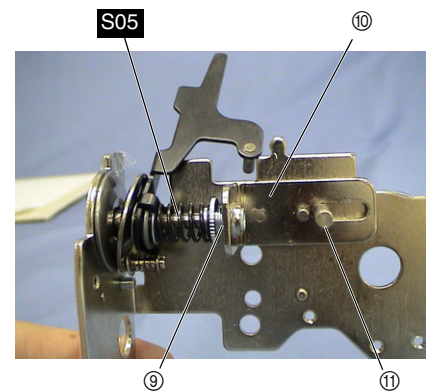
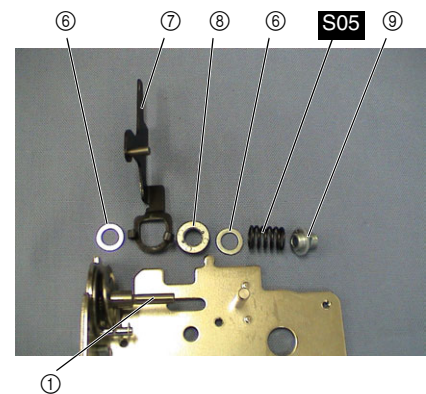
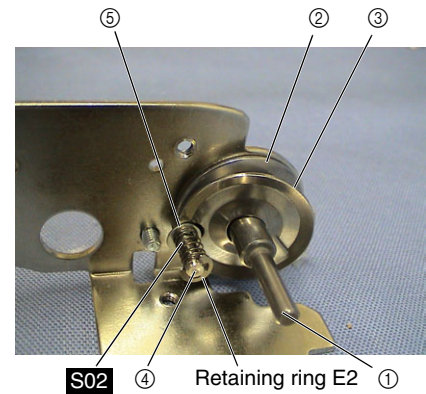

## 6 Thread release link attachment

1. Insert the thread release link ① into the pin of the tension release holder ②, and attach the retaining pin (E3).



## 7 Tension plate attachment

1. Place the spacer ① on the tension release holder assembly ②.

### \*Key point

- Engage the positioning tab on the tension release holder assembly ② with the square-positioning hole on the spacer ①.
2. Place the tension plate ③ and the spring S02 onto the calking shaft of the tension release holder assembly ②, and attach the retaining ring (E2).

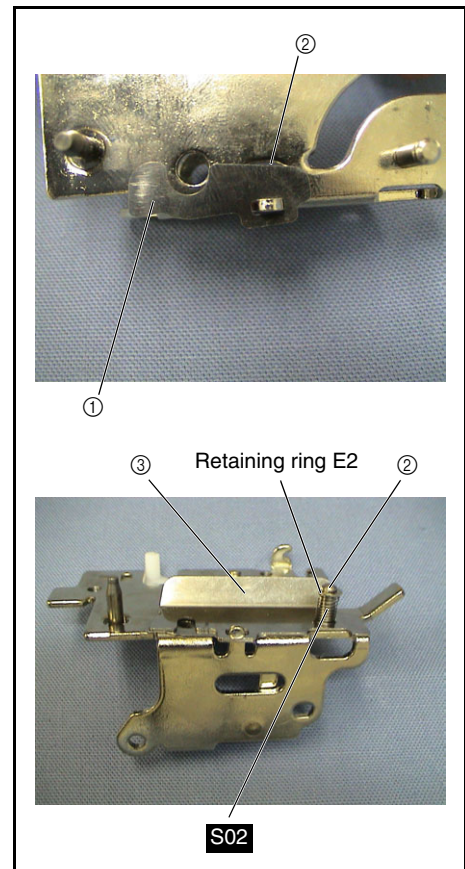

S02

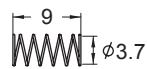
SPRING  
X57605\*\*\*



## 8 Tension presser plate assembly attachment

1. Attach the screw ① to the tension presser plate assembly ①.

### \*Key point



- Tighten the screw ① until it protrudes from the bottom of the tension presser plate assembly ① 0.2 - 0.5 mm.
2. Apply a small bead of EPCON AP(N) 0 to the tension release link contact surface of the tension release cam ②.
  3. Temporarily attach the screw ② to the tension release cam ②.
  4. Insert the tension presser plate assembly ① from the top of the tension release holder assembly, and then insert the spring S03 and the tension release cam ② from the bottom.
  5. Thread the tension presser plate assembly ① through to the bottom.

### \*Key point

- After threading the tension presser plate assembly ① through to the bottom, insert the positioning tab on the tension release holder assembly into the square positioning hole ③ on the tension plate.
6. Set the screw ① of the tension presser plate assembly ① as shown in the illustration on the right, and fully tighten the screw ② of the tension release cam ②.

Apply EPCON AP(N) 0 to the tension release link contact surface of the tension release cam.

Small bead  
XC8387\*\*\*

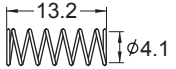
①		Power Lock 2X3	Torque 0.78 – 1.18 N·m
②		Set Screw, Socket (FT) M3X4	Torque 0.78 – 1.18 N·m
S03		SPRING XA9577***	

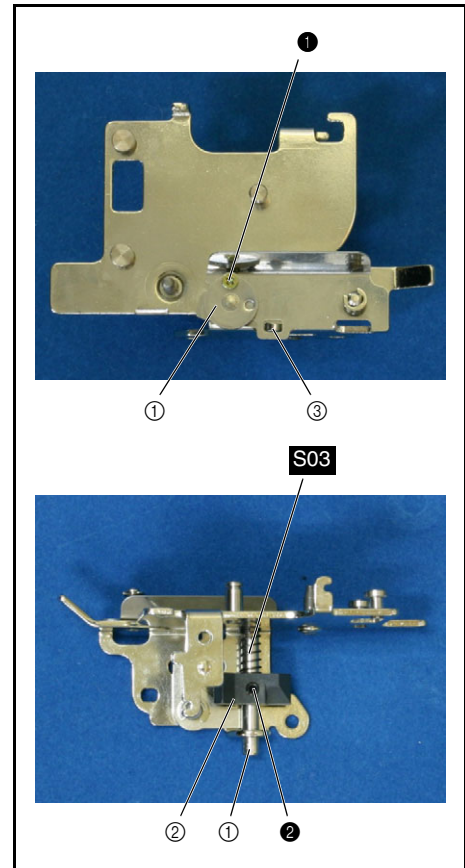



## 9 Tension release holder assembly attachment

1. Attach the tension release holder assembly ① to the thread guard assembly ② with the 2 screws ①.

### \*Key point

- The tension release plate A ③ and the presser SW link ④ should be positioned as shown in the illustration on the right when the tension release holder assembly ① is attached.

### NOTE

- Check that the tension plate rises when the tension release plate A ③ is moved to the right.

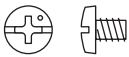
①		Screw, Bind M3X4	Torque 0.78 – 1.18 N·m
---	---	---------------------	---------------------------

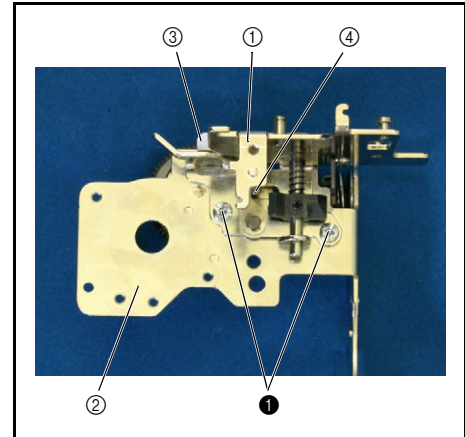

## 10 Thread guide shutter attachment

1. Attach the thread guide shutter ① and the thread guide shutter link B ② with the retaining ring (E3).

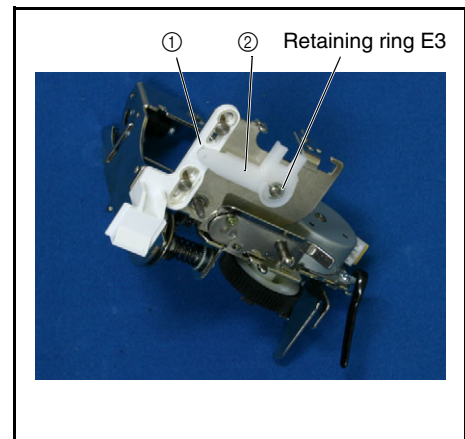

## 11 AT pulse motor assembly attachment

1. Apply 1 or 2 drops of FBK OIL RO 100 to the shaft of the AT pulse motor assembly ①.
2. Insert the AT pulse motor lead wire assembly ③ to the connector of the AT pulse motor assembly ②.
3. Attach the AT pulse motor assembly ④ to the thread guard with the 2 screws ①.

Apply FBK OIL RO 100 to the shaft of the AT pulse motor assembly.	1 - 2 drops XC8388***
---	--------------------------

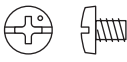
①		Screw, Bind M3X4	Torque 0.78 – 1.18 N·m
---	---	---------------------	---------------------------

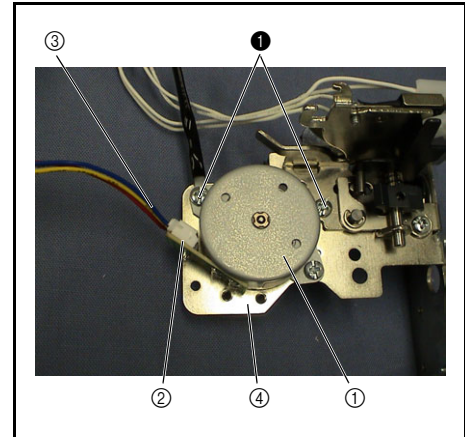

## 12 Thread guide shutter link A ASSY assembly

1. Insert the link A shaft plate assembly ② into the thread guide shutter link A assembly ①, and secure these with the retaining ring (E3).

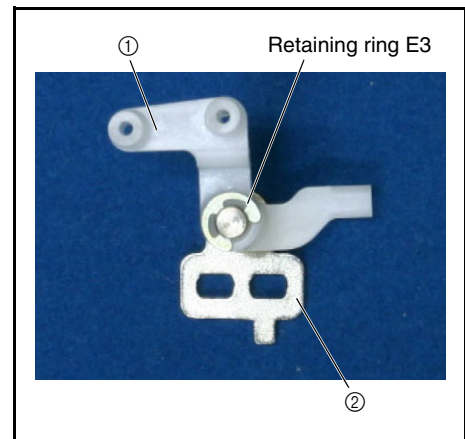

## 13 Thread guide shutter link A assembly attachment

1. Temporarily attach the thread guide shutter link A assembly ① with the screw ①.

①		Screw, Pan (S/P washer) M3X6	Torque
---	---	---------------------------------	--------

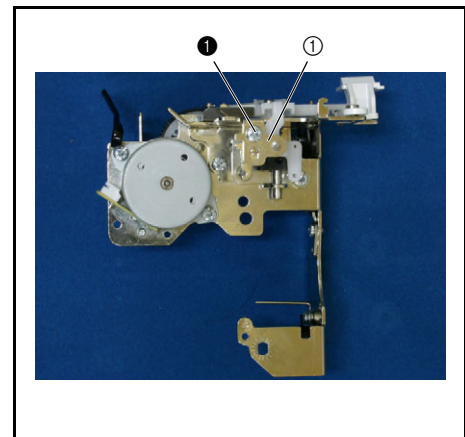

## 14 Plate assembly attachment

1. Attach the plate assembly ① with the screw ❶.

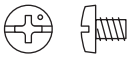
❶		Screw, Bind M3X4	Torque 0.78 – 1.18 N·m
---	---	---------------------	---------------------------

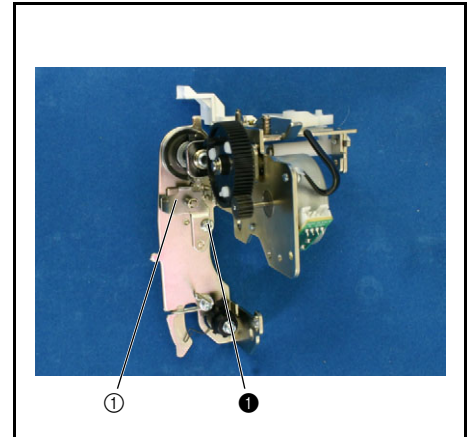

## 15 AT INIT PCB ASSY assembly

1. Attach the insulation sheet ① and the AT INIT PCB assembly ② to the AT pulse motor sensor holder ③ with the screw ❶.

### \*Key point

- When attaching the insulation sheet ①, attach the section ④ of the insulation sheet ① to the rear side of the AT pulse motor sensor holder ③.
- Engage the positioning tab on the AT pulse motor sensor holder ③ (center tab of 3 tabs) with the positioning notch (U-shape) on the AT INIT PCB assembly ②.
- Move the AT INIT PCB assembly ② to the notch right and left tabs of 3 tabs on the AT pulse motor sensor holder ③.

❶		Screw, Bind M3X4	Torque 0.78 – 1.18 N·m
---	---	---------------------	---------------------------

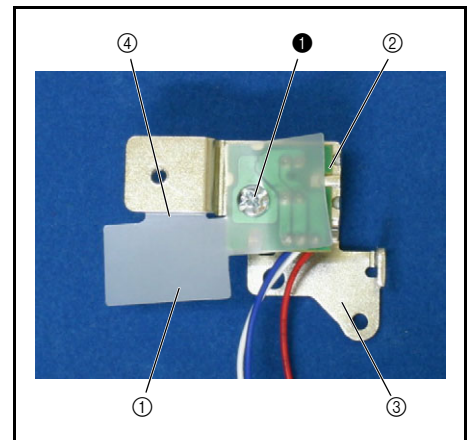

## 16 AT INIT PCB assembly attachment

1. Attach the AT INIT PCB assembly ① to the thread guard assembly with the screw ❶.

### \*Key point

- Engage the positioning tab on the thread guard with the positioning hole on the AT INIT PCB assembly ①.

### NOTE

- Rotate the thread tension gear counterclockwise until it stops, and check that the shutter of the thread tension gear assembly is almost at the center relative to the sensor of the AT INIT PCB assembly ①.

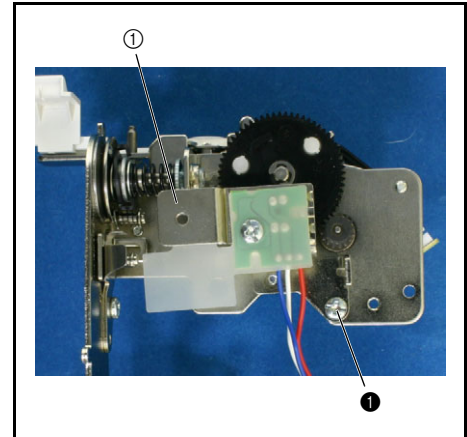

❶		Screw, Bind M3X4	Torque 0.78 – 1.18 N·m
---	---	---------------------	---------------------------

## 17 Upper thread PCB ASSY assembly

1. Attach the upper thread PCB assembly ① to the thread sensor holder ② with the screw ❶.

### \*Key point

- Engage the positioning tab on the thread sensor holder ② with the center of the positioning slot ③ on the upper thread PCB assembly ①.

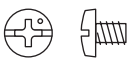
❶		Screw, Bind M3X4	Torque 0.78 – 1.18 N·m
---	---	---------------------	---------------------------

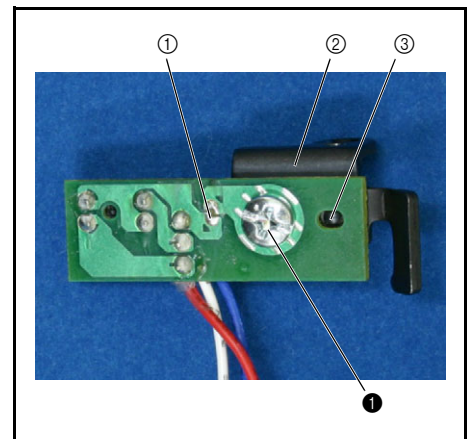

## 18 Upper thread PCB assembly attachment

1. Attach the upper thread PCB assembly ① to the thread guard assembly with the screw ①.

### \*Key point

- Engage the positioning tab on the thread guard assembly with the positioning hole on the upper thread PCB assembly ①.

### NOTE

- Check that the shutter of the thread cutting shutter ② is almost at the center relative to the sensor of the upper thread PCB assembly ①.

①		Screw, Bind M3X4	Torque 0.78 – 1.18 N·m
---	---	---------------------	---------------------------

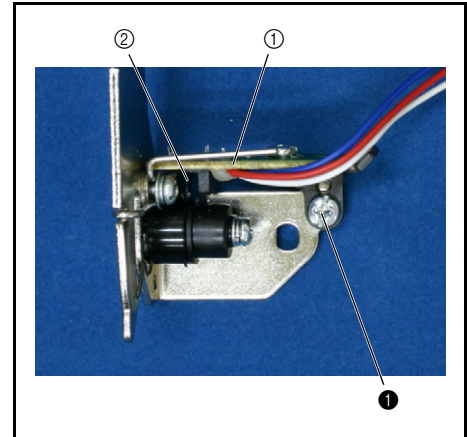

## 19 Thread guide attachment

1. Attach the thread guide ① to the thread guard assembly with the screw ①.

### \*Key point

- Engage the tab on the thread guard assembly (rear of AT pulse motor attachment screw) with the positioning notch on the thread guide ① (U-shape).

①		Screw, Bind M3X4	Torque 0.78 – 1.18 N·m
---	---	---------------------	---------------------------

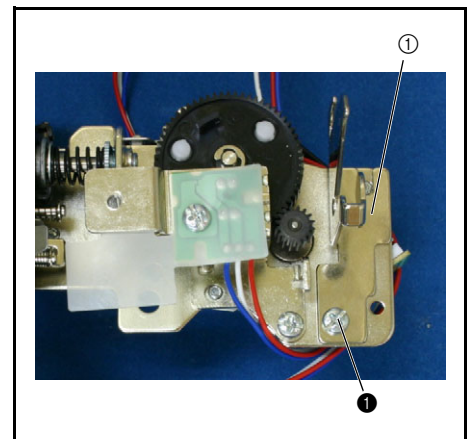

## 20 Thread guide assembly attachment

1. Attach the thread guide assembly to the needle-presser module with the 2 screws ①.

### \*Key point

- Engage the positioning tab on the needle-presser module with the positioning hole on the thread guide assembly.

①		Taptite, Bind B M4X10	Torque 1.18 – 1.57 N·m
---	---	--------------------------	---------------------------

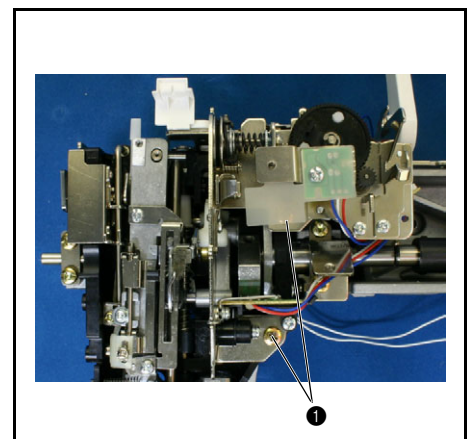

## 21 Thread guide cover attachment

1. Attach the thread guide cover ① to the thread tension unit.

### \*Key point

- Engage the 2 lugs (②, ③) on the thread tension unit in the 2 grooves (④, ⑤) on the thread guide cover ①, and then attach the thread guide cover behind the boss ⑥.

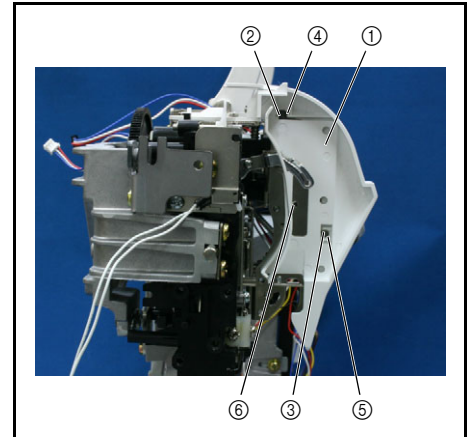

## 22 Thread guide cover ASSY assembly

1. Attach the thread take-up cover ② and the thread guide ① to the thread guide cover assembly with the screw ①.

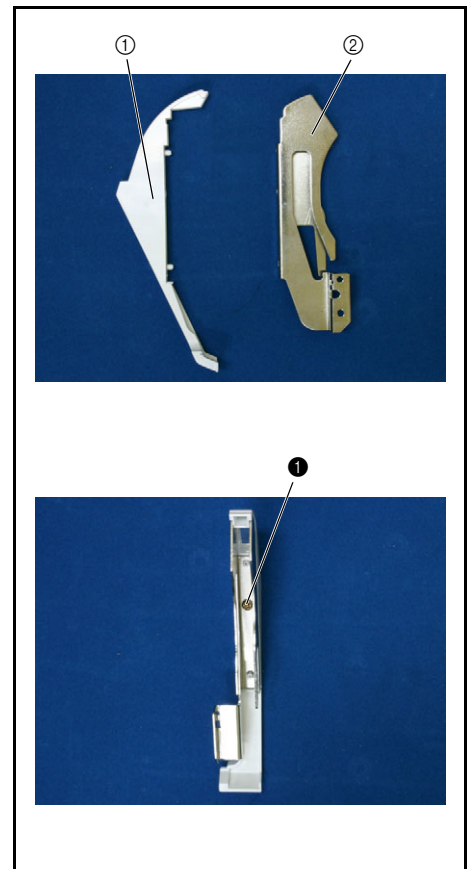

①		Tapite, Pan B M3X6	Torque 0.78 – 1.18 N·m
---	--	-----------------------	---------------------------

## 23 Thread guide cover assembly attachment

1. Attach the thread guide cover assembly ① with the 2 screws ①.

### \*Key point

- Align the thread guide cover ① with the thread guide cover ②, so there is no step between them.

### NOTE

- Be sure to perform [4-16 Thread guide shutter clearance adjustment].

①		Screw, Pan (S/P washer) M3X6	Torque 0.78 – 1.18 N·m
---	--	---------------------------------	---------------------------

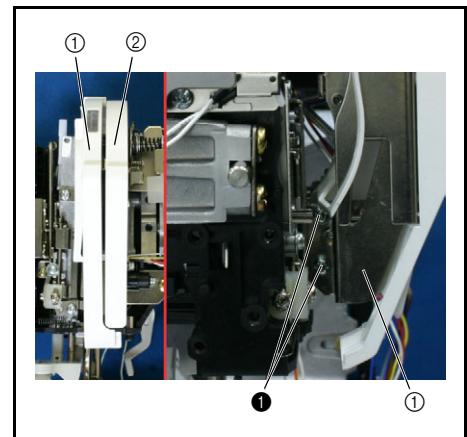



Power unit, motor unit location diagram

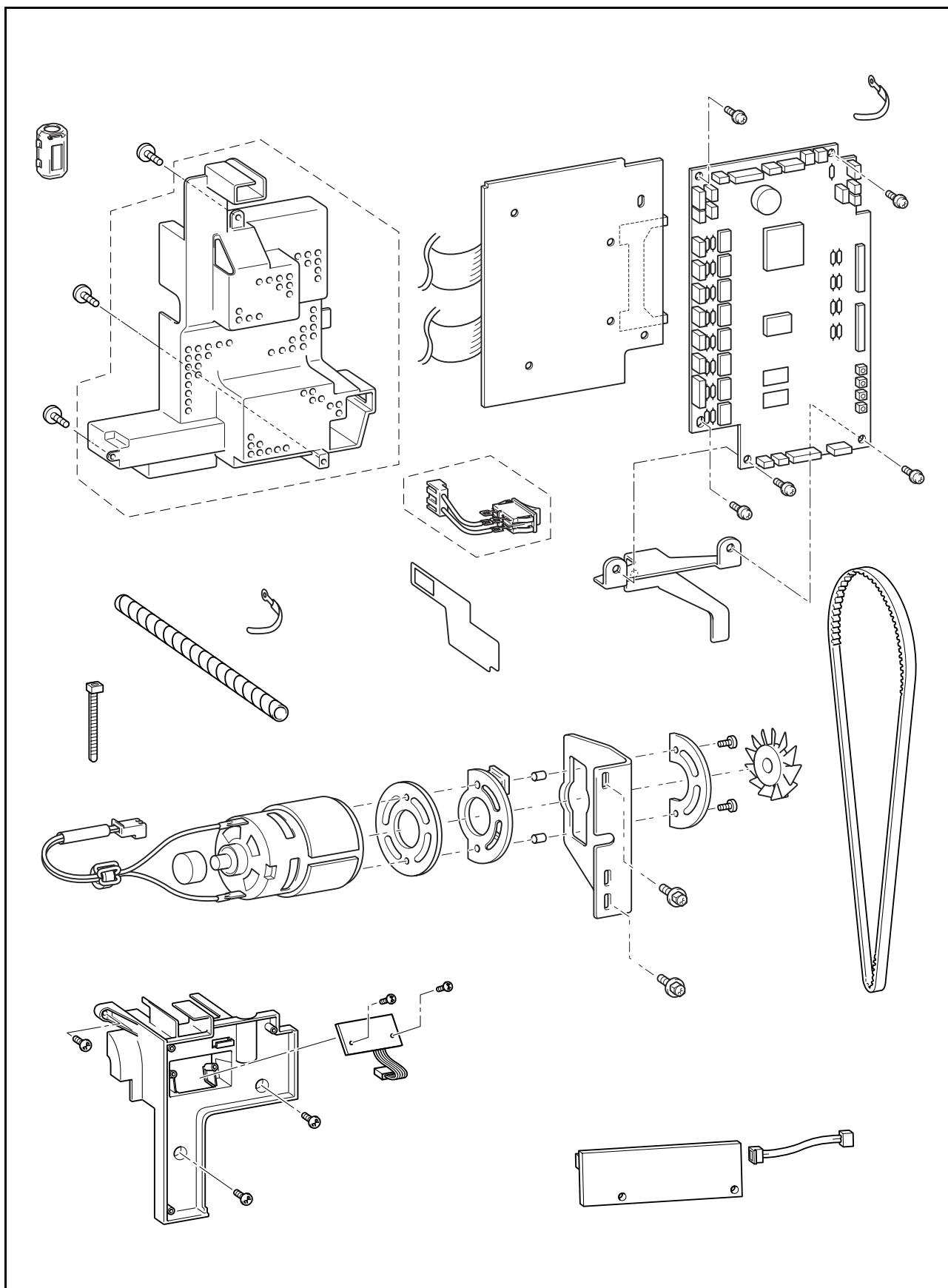

## 1 Main motor assembly attachment

1. Hang the timing belt over the timing pulley ① of the upper shaft and the pulley ② of the motor.
2. Set the main motor assembly ③ onto the arm bed, and then tighten the upper screw ① temporarily.
3. Set PCB holder R ④ onto the main motor assembly ③, and then tighten the lower screw ① temporarily.
4. Adjust the timing belt tension, and then fully tighten the 2 screws ①.

### \*Key point

- Refer to "Motor belt tension adjustment" on page 4 - 4 for the adjustment procedure.

①		Upset 4X12DB  Torque 1.18 – 1.57 N·m
---	---	--

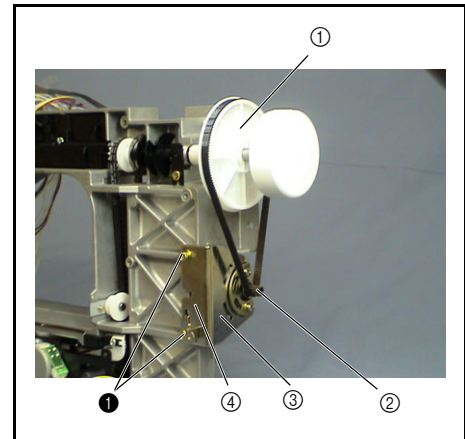

## 2 Motor fan attachment

1. Insert the motor fan ① to the motor pulley.

### NOTE

- Be careful removing the motor fan because the wings of the fan are very fragile.

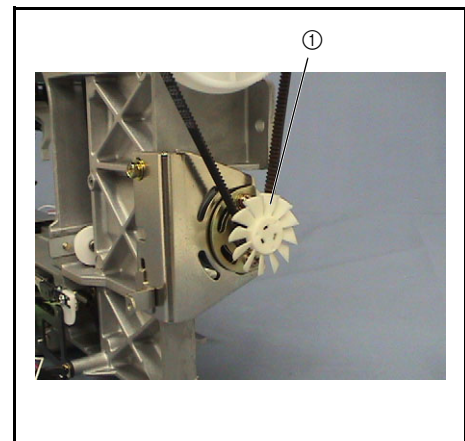

## 3 NP PCB ASSY (D6) assembly

1. Place the insulation sheet ② on the NP PCB assembly (D6) ①, and secure it to the PCB holder ③ with the 2 screws ①.
2. Pass the lead wire of the NP PCB assembly (D6) ① through the PCB holder guide ④.

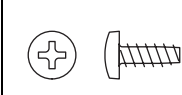
①		Taprite, Bind B M3X8  Torque 0.59 – 0.78 N·m
---	---	--

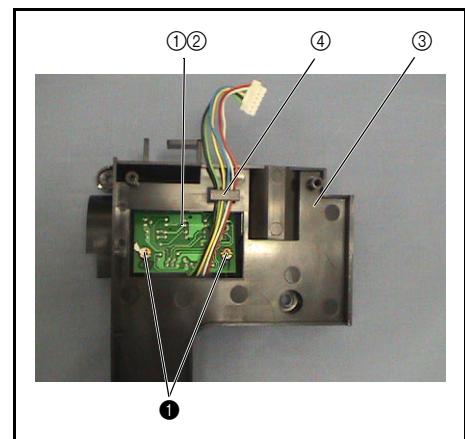

#### 4 NP PCB assembly attachment

1. Attach the NP PCB assembly (D6) ① to the arm bed with the 3 screws ①.

##### NOTE

- Attach the NP PCB assembly (D6) ① carefully to avoid damaging the sensor on the rear of the assembly.
- Be careful not to allow the sensor of the NP PCB assembly (D6) ① to contact the upper shaft shutter.

##### \*Key point

- Refer to "Upper shaft rotation shutter angle adjustment" on page 4 - 5 for shutter angle adjustment.
- Refer to the "Wiring procedures" for details.

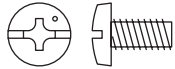
①		Screw, Bind M4X8	Torque 0.78 – 1.18 N·m
---	---	---------------------	---------------------------

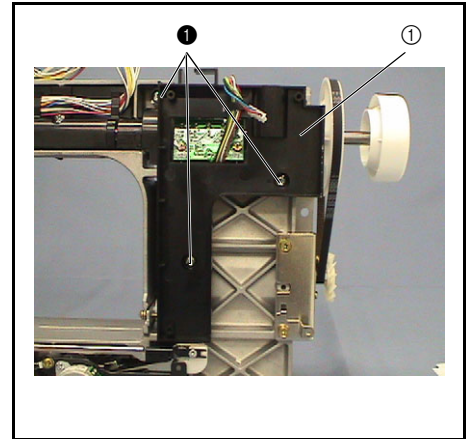



#### 5 Main PCB assembly attachment

1. Attach the main PCB assembly ① to the PCB holder and PCB holder R with the 3 screws ① (CS1 clip ② is attached to the right upper screw) and the screw ②.

##### \*Key point

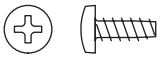
- Attach the clip (CS1) ② at an angle of 45° (lower left) as shown in the drawing on the right.
- Refer to the "Wiring procedures" for details.

①		Tapite, Bind B M3X8	Torque 0.59 – 0.78 N·m
②		Screw, Bind M3X6	Torque 0.59 – 0.78 N·m

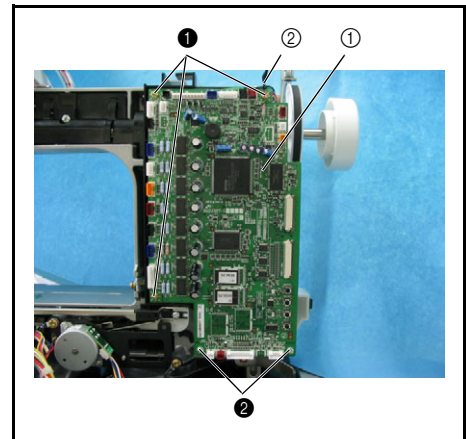

## 6 Embroidery unit connector assembly attachment

1. Attach the embroidery unit connector assembly ① to the base plate ② with the 2 screws ①.

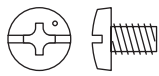
①		Screw, Bind M4X6	Torque 0.79 – 1.18 N·m
---	---	---------------------	---------------------------

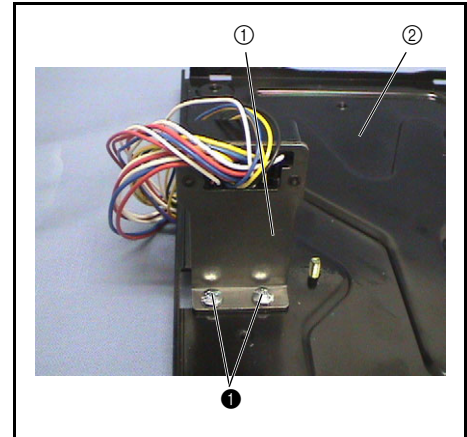

## 7 Knee lifter assembly attachment

1. Attach the knee lifter assembly ① to the base plate ② with the 2 screws ①.

①		Screw, Bind M4X6	Torque 0.79 – 1.18 N·m
---	---	---------------------	---------------------------

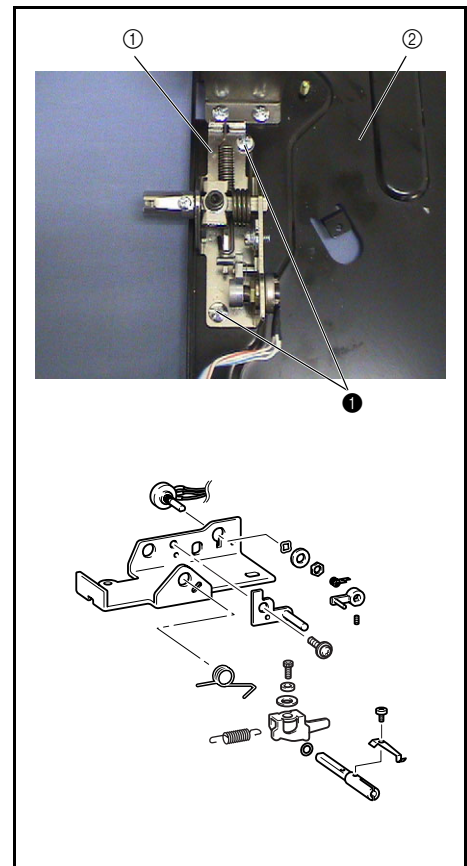

## 8 Inlet assembly attachment

1. Attach the inlet assembly ① to the base plate ② with the screw ①.

### \*Key point

- Engage the 2 positioning tabs on the inlet assembly ① with the corresponding positioning holes on the base plate ②.

①		Screw, Bind M4X6	Torque 0.79 – 1.18 N·m
---	---	---------------------	---------------------------

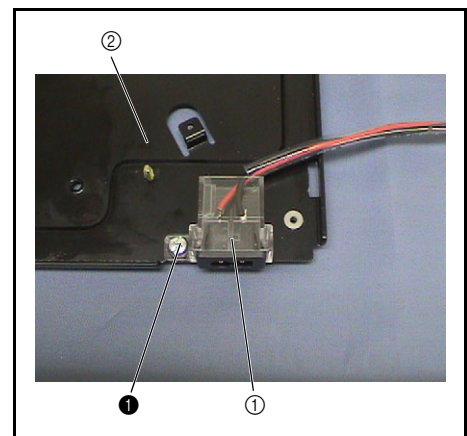

## 9 Base plate assembly attachment

1. Attach the base plate assembly ① to the arm bed with the 3 screws ①.

<b>①</b>		Taprite, Bind S M4X10	Torque 1.47 – 1.96 N·m
----------	---	--------------------------	---------------------------

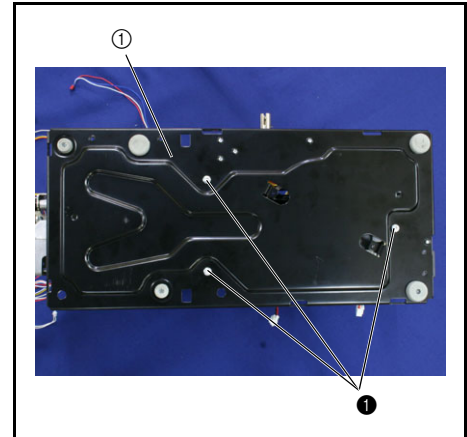

## 10 Ferrite core attachment

1. Attach the ferrite core ① to the power PCB assembly (D6US).

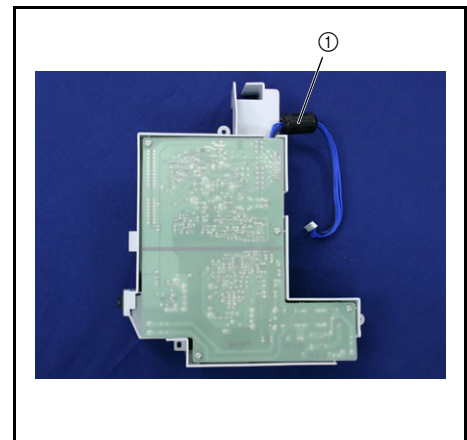

## 11 Power switch assembly (D6) attachment

1. Attach the power switch assembly (D6) ① and the insulator sheet (S) ② to the power unit cover ③.

### NOTE

- Attach the power switch assembly (D6) so that the " O " mark on it is at the position shown in the photo on the right.
2. Attach the connector ④ of the power switch assembly (D6) ① to the power PCB assembly (D6US).

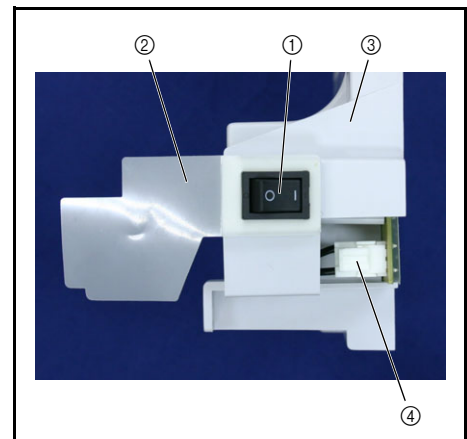

## 12 Power PCB assembly (D6US) attachment

1. Attach the power PCB assembly (D6US) ① to the arm bed with the 3 screws ①.

### NOTE

- Be careful not to pinch the inlet cord and motor cord.

2. Insert the motor cord ② and the inlet cord ③ into the power PCB assembly (D6US) ①.

### \*Key point

- Refer to "Wiring procedure" for wiring details.

①		Screw, Pan (SIP washer) M4X14	Torque 0.78 – 1.18 N·m
---	--	----------------------------------	---------------------------

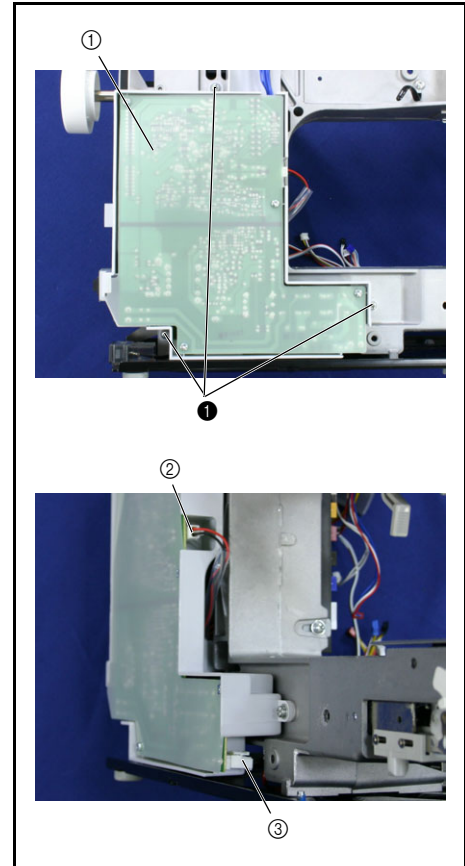



Main parts location diagram

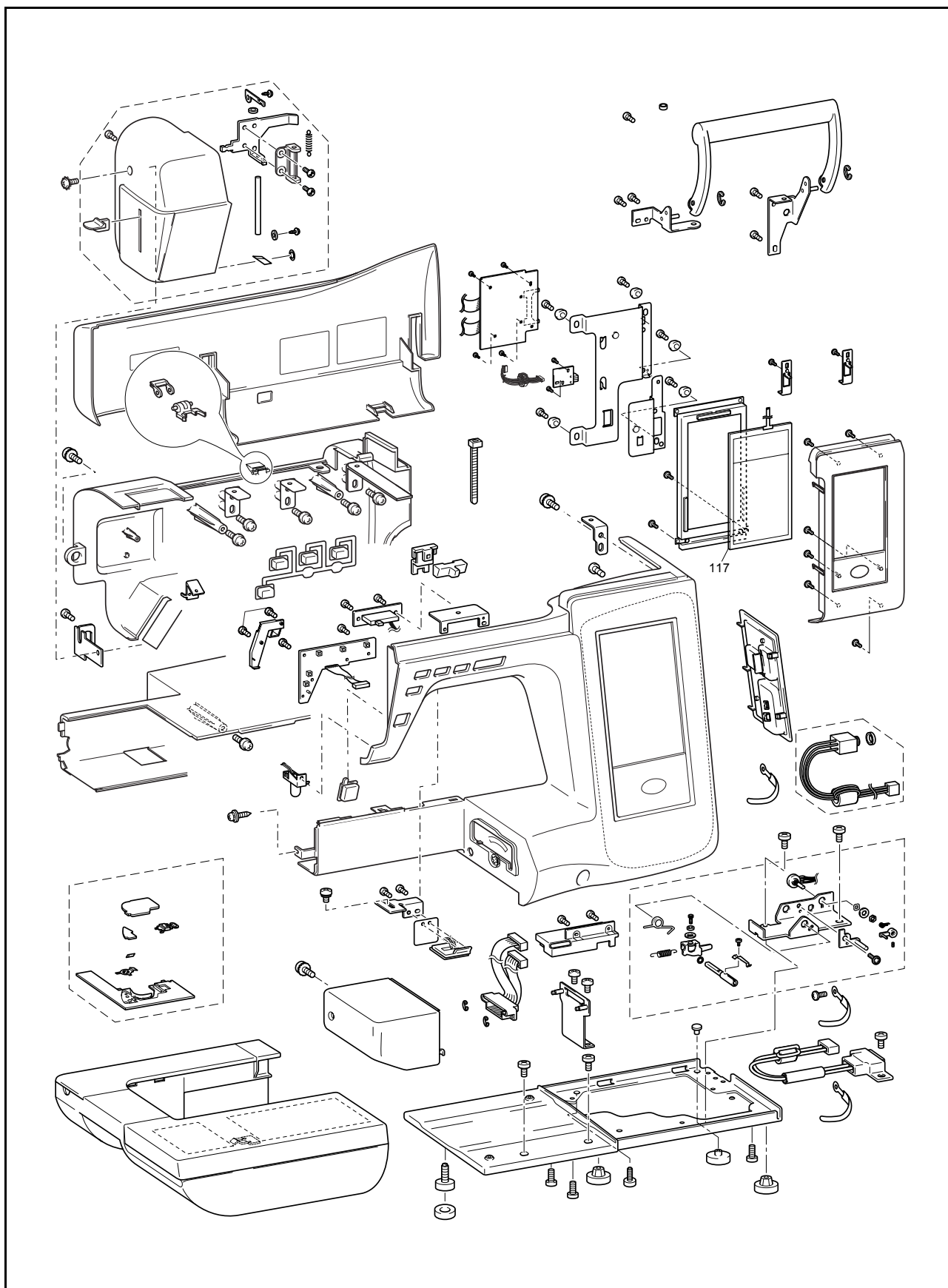

## 1 Handle assembly

1. Attach the handle holder R assembly ① to the inside of the handle ②, and then attach the retaining ring (E4).
2. Attach the handle holder L assembly ③ to the outside of the handle ②, and then attach the retaining ring (E4).

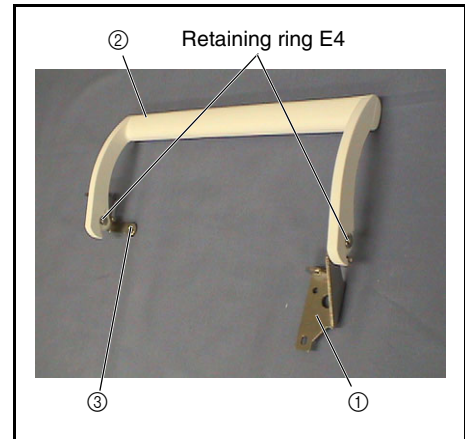

## 2 Handle assembly attachment

1. Attach the handle assembly ① to the rear of the arm bed with the 4 screws ①.

①		Taptite, Bind S M4X10	Torque 1.47 – 1.98 N·m
---	---	--------------------------	---------------------------

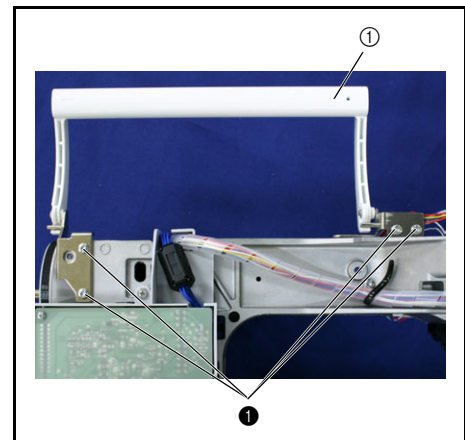

## 3 Drop cover attachment

1. Place the drop cover ① onto the tab on the drop knob as shown in the illustration on the right.

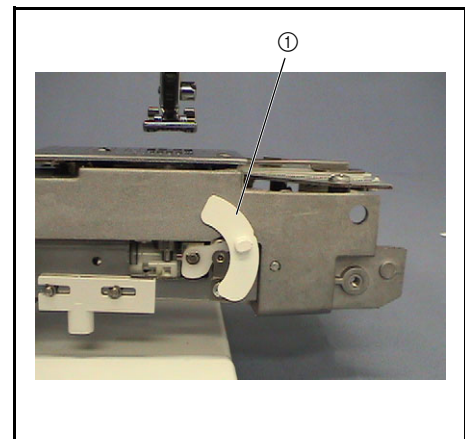

## 4 Rear cover assembly (Plate A attachment)

1. Attach the plate A ① (2 locations) to the inside of the rear cover with the screw ①.

### \*Key point

- Engage the positioning tab on the rear cover with the positioning hole on plate A.

①		Taptite, Cup B M4X10	Torque 0.59 – 0.98 N·m
---	---	-------------------------	---------------------------

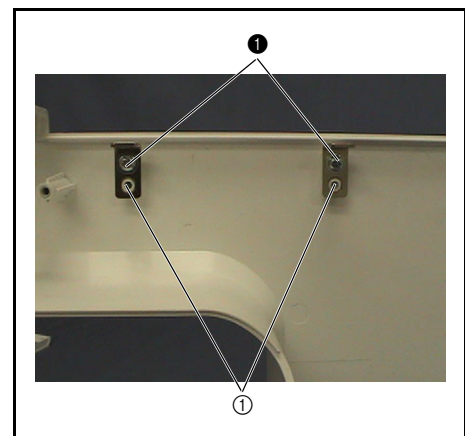

## 5 Rear cover assembly (plate B attachment)

1. Attach the plate B ① to the inside of the rear cover with the screw ❶.

### \*Key point

- Engage the positioning tab on the rear cover with the positioning hole on plate B.

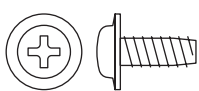
❶		Taptite, Cup B M4X10	Torque 0.59 – 0.98 N·m
---	---	-------------------------	---------------------------

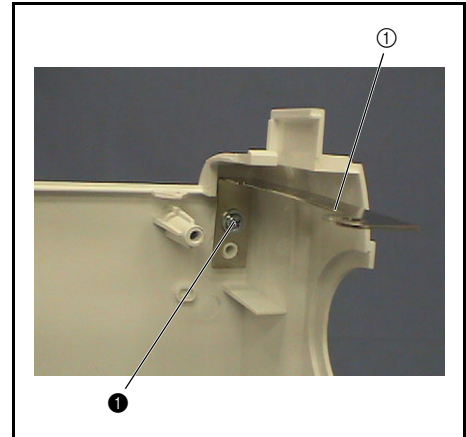

## 6 Rear cover attachment

1. Attach the rear cover ① to the arm bed with the 3 screws ❶.

### \*Key point

- Attach the 2 hooks ② on the rear cover to the base plate.
- Engage the positioning tab ③ on the rear cover with the positioning hole on the rear of the arm bed.

❶		Taptite, Cup B M4X14	Torque 1.18 – 1.57 N·m
---	---	-------------------------	---------------------------

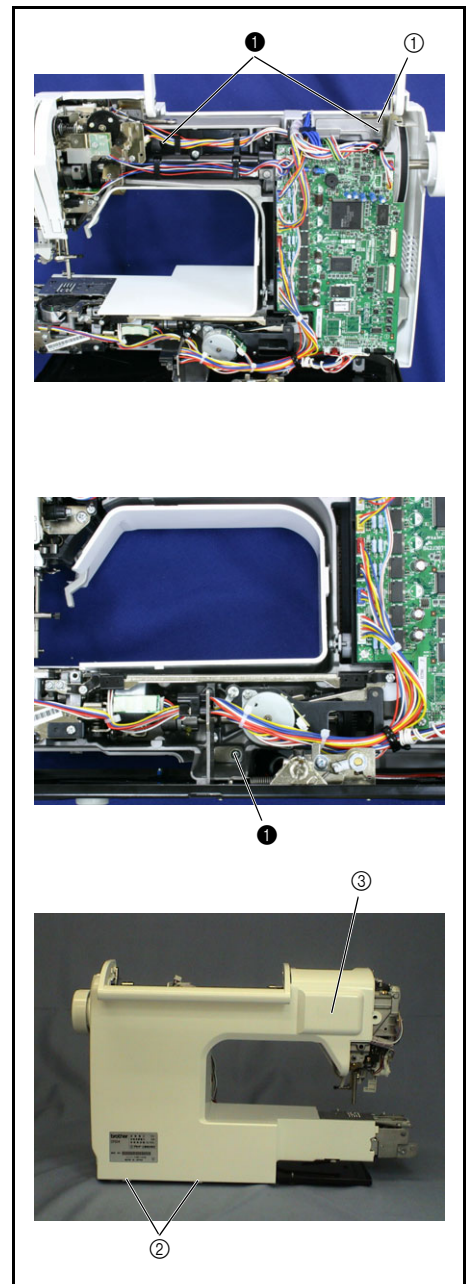

## 7 Front cover assembly (LCD assembly attachment)

1. DECO plate ① with the 2 screws ①.
2. Attach the touch panel ① and the LCD ② with the 2 screws ②.
3. Attach the 2 LCD pressers ③ with the 2 screws ③.

①		Taptite, Bind B M3X8	Torque 0.39 – 0.79 N·m
②			
③			



## 8 Front cover assembly (SV keytop attachment)

1. Attach the SV joint plate ① to the rear of the front cover.
2. Attach the SV keytop ② to the hole on the SV joint plate ① from outside the front cover.

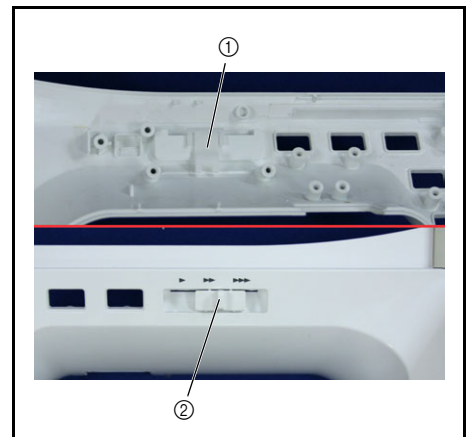

## 9 Front cover assembly (LCD holder assembly attachment)

1. Pass the touch panel's FFC ②, the LCD panel's lead wire ③, and the LCD panel's ④ through the holes (3 locations) on the LCD holder assembly section of the front cover.
2. Attach the LCD holder assembly ① to the LCD holder assembly attachment section on the front cover.

### \*Key point

- Set the right hooks (3 locations) of the LCD holder assembly ① into the LCD holder assembly attachment section, and then attach the left hooks (2 locations).

3. Tighten the 4 screws ① from the inside of the front cover.

### \*Key point

- Tighten the screws ① in the following order: ①-1, ①-2, ①-3, and ①-4.

①		Taptite, Bind B M3X8	Torque 0.39 – 0.79 N·m
---	---	-------------------------	---------------------------



## 10 Front cover assembly (foot controller jack assembly attachment)

1. Attach the foot controller jack assembly ① to the rear of the front cover.

### \*Key point

- Position the mark on the foot controller jack assembly ① face up.
2. Attach the nut to the outer surface of the top cover and tighten the jack with a jack screwdriver.

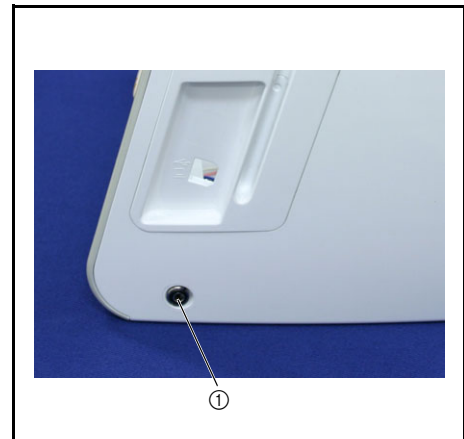

## 11 Front cover assembly (connector cover attachment)

1. Attach the connector cover ① to the shaft inside the front cover, and attach the retaining ring (CS4).

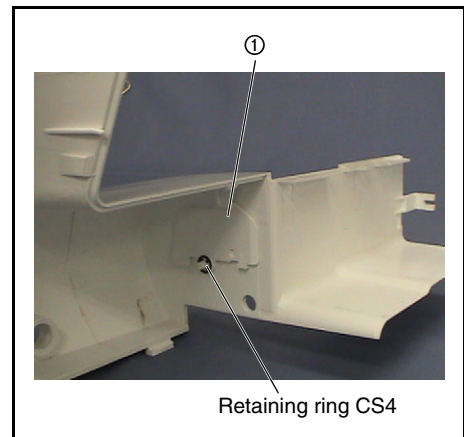



## 12 Front cover assembly (card PCB cover assembly attachment)

1. Press the pen holder ① into the groove ② on the card PCB cover to attach it.
2. Attach the card PCB cover assembly ③ to the side face of the front cover.

### \*Key point

- Set the right hooks (3 locations) of the card PCB cover assembly ③ into the side face of the front cover, and then attach the left hooks (2 locations).

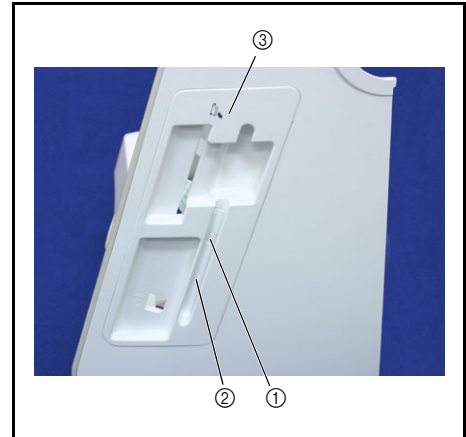

## 13 Front cover assembly (PCB holder assembly attachment)

1. Attach the card PCB ② to the card PCB holder ① with the 4 screws ①.
2. Attach the USB PCB ④ to the USB PCB holder ③ with the 2 screws ②.
3. Position the card PCB holder ① on the front cover, and secure these using the 3 board pressers with the 3 screws ③.
4. Position the USB PCB holder ③ on the front cover, and secure these using the 2 board pressers with the 2 screws ③.
5. Attach the 6 connectors, FFC ⑤, and FFC ⑥.

### \*Key point

- Release the knob when inserting the FFC ⑤ and lock the knob after insertion.

①		Tapite, Bind B M3X10	Torque 0.39 – 0.79 N·m
②		Screw, Bind M3X5	Torque 0.39 – 0.79 N·m

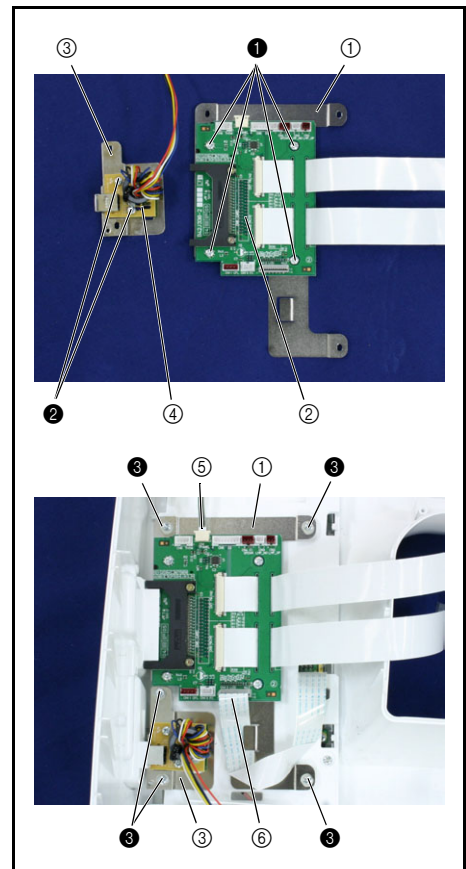



## 14 Front cover assembly (inverter D6 assembly attachment)

1. Attach the inverter D6 ① to the inverter cover ② with the 2 screws ①.
2. Connect the inverter lead wire assembly's connector ③ to the left side of the inverter D6 ①.
3. Connect the LCD lead wire connector ④ from the lower section inside the front cover to the right connector on the inverter D6 ①.
4. Attach the inverter D6 assembly to the rear of the front cover with the 2 screws ② (attach the clip ⑦ to the left screw).

### \*Key point

- Pass the LCD lead wire ④ through the notch ⑤ on the inverter D6 assembly.
5. Insert the clip ⑦ through the ferrite core ⑥ of the foot controller jack assembly.

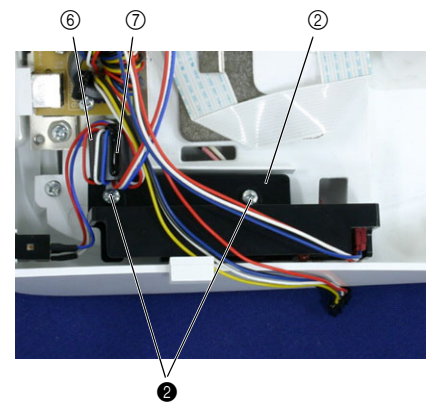
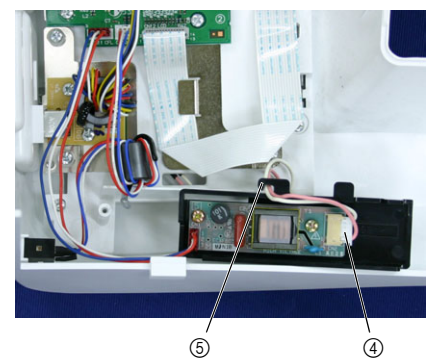
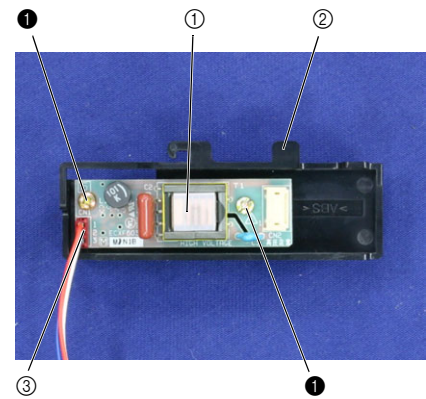

① ②		Taptite, Bind B M3X8	Torque 0.39 – 0.79 N·m
--------	--	-------------------------	---------------------------

## 15 Front cover assembly (plate D attachment)

1. Attach the plate D ① to the rear of the front cover with the screw ①.

### \*Key point

- Engage the positioning tab on the front cover with the positioning hole on the plate D.

①		Taptite, Cup B M4X10	Torque 0.59 – 0.98 N·m
---	--	-------------------------	---------------------------

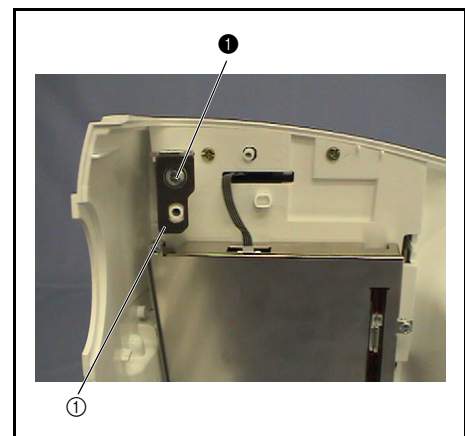

## 16 Front cover assembly (button attachment)

1. Attach the SS button ①, and the operation button ②, to the rear of the front cover.

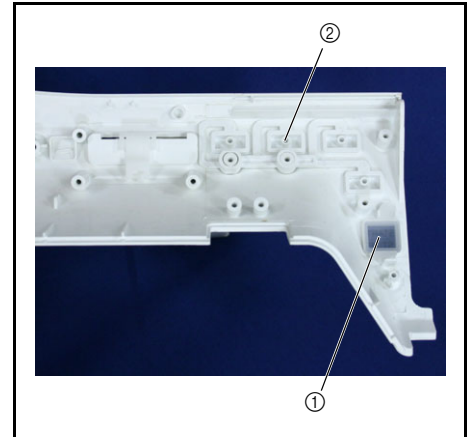

## 17 Front cover assembly (SS PCB assembly attachment)

1. Attach the SS PCB assembly ① to the SS button on the rear of the front cover with the 2 screws ①.

### \*Key point

- Insert each switch section on the SS PCB assembly ① into the SS button.
- Tighten the screws ① in the following order: ①-1 and ①-2.

2. Attach the S holder ② to the SS PCB assembly ① with the 2 screws ②.

### \*Key point

- Tighten the screws ② in the following order: ②-1 (temporarily tighten), ②-2 (fully tighten), and ②-1 (fully tighten).

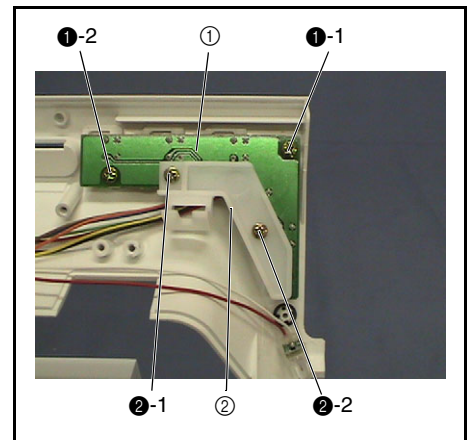



①		Taprite, Bind B M3X8	Torque 0.39 – 0.79 N·m
②		Taprite, Bind B M3X14	Torque 0.39 – 0.79 N·m

## 18 Front cover assembly (VR PCB assembly attachment)

1. Align the screw hole on plate C ① with that on the VR PCB ②.
2. Attach the VR PCB assembly to the inside of the front cover with the 2 screws ①.

### \*Key point

- Insert the sensor of the VR PCB assembly into the notch on the SV joint plate.
- Engage the positioning tab on the front cover with the positioning notch (lower left) on the VR PCB assembly.
- Tighten the screws ① in the following order: ①-1 (temporarily tighten), ①-2 (fully tighten), and ①-1 (fully tighten).

①			Taplite, Bind B M3X8	Torque 0.39 – 0.79 N·m
---	---	---	-------------------------	---------------------------

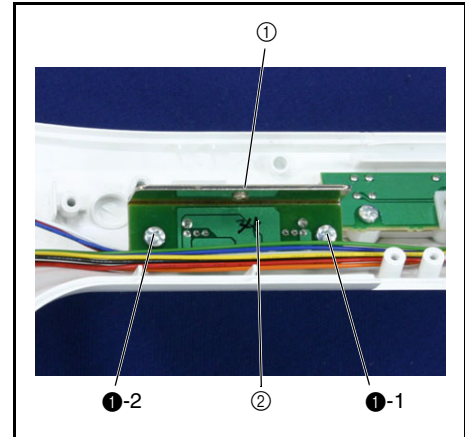



## 19 Front cover assembly (LED lamp 3 attachment)

1. Attach the LED lamp 3 ①, adjusting plate B ②, and insulation sheet ③ to the inside of the front cover with the 2 screw ①.

### \*Key point

- Engage the LED lamp 3 ① with the notch on the front cover, and then align the adjusting plate B ② and the insulation sheet ③ with the screw hole.
- Tighten the screws ① in the following order: ①-1 (temporarily tighten), ①-2 (fully tighten), and ①-1 (fully tighten).

①			Taplite, Bind B M3X10	Torque 0.39 – 0.79 N·m
---	---	---	--------------------------	---------------------------

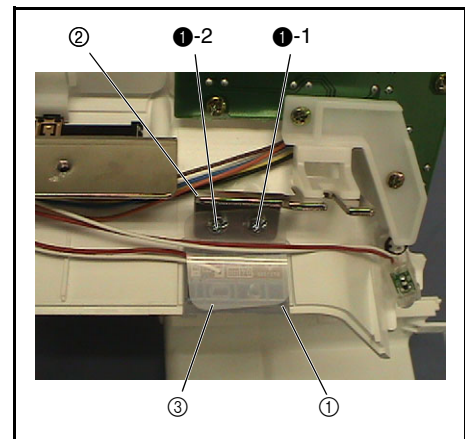

## 20 Front cover assembly (LED lamp R attachment)

1. Place the LED lamp R ① onto the LED lamp R attachment shaft inside the front cover, and then attach the retaining ring (CS4).

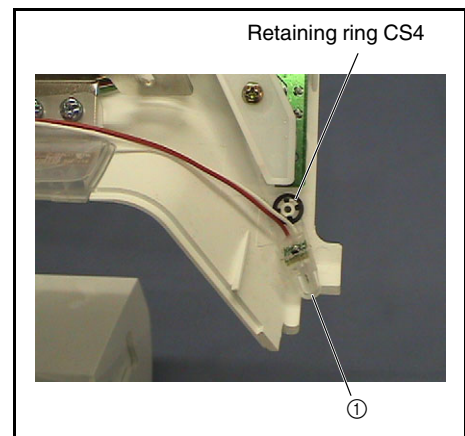

**21** Front cover assembly (panel PCB connector attachment)

1. Connect the connectors to the card PCB ①.

**\*Key point**

- Refer to "Wiring procedures".
2. Tie the lead wires with a band ②.

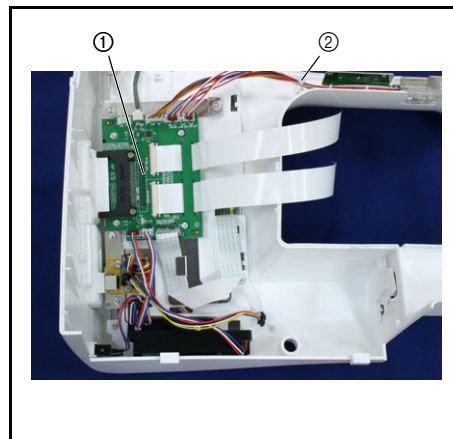

## 22 Front cover attachment

1. Connect the two FFC cords ① of the card PCB to the connector on the main PCB ②, and lock them with the connector tabs on both ends.

**\*Key point**

- Check that the tabs on the connector on the main PCB ② are released before connecting the FFC cords ①.

2. Connect the lead wire connector ③ to the main PCB ②.
3. Attach the front cover.

**\*Key point**

- Hang the hooks ④ on the front cover (2 locations) over the base plate.
- Hang the center hook ⑤ on the front cover over the rear cover.
- Attach the hook ⑥ to the lug on the rear cover.

4. Secure the front cover with the screws ① (fully tighten) and ② (temporarily tighten).

**\*Key point**

- Tighten the screw ② fully after attach the bobbin winder. (Refer to "Bobbin winder attachment" on page 3 - 51)

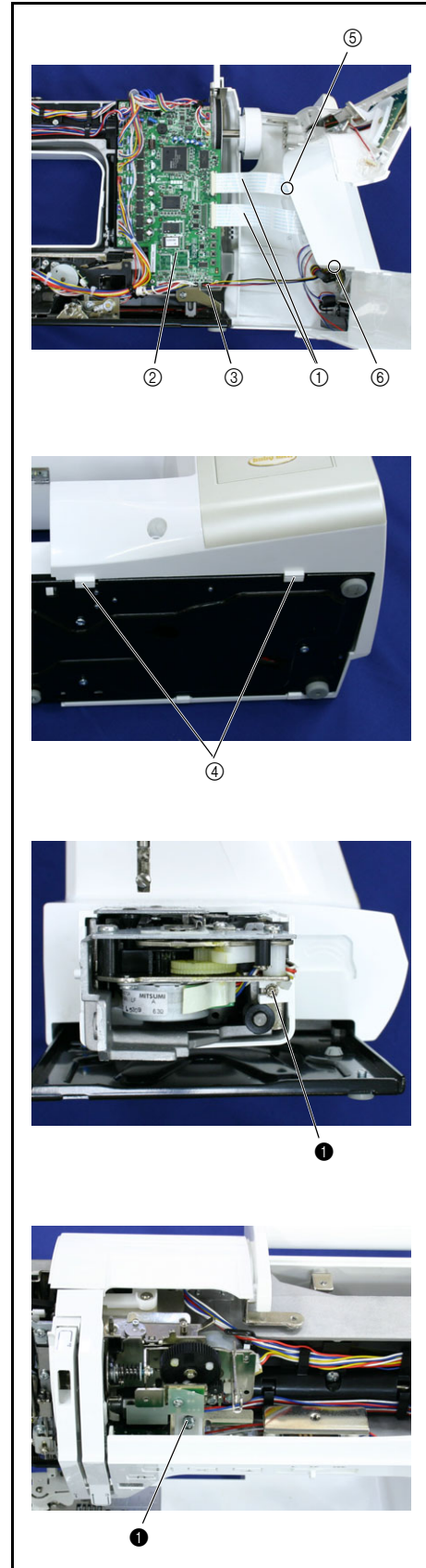

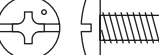
①		Screw, Pan (T washer) M3X6	Torque 0.57 – 0.78 N·m
②		Screw, Bind M4X8	Torque 0.78 – 1.18 N·m



### 23 Bobbin winder attachment

1. Connect the 2 lead wire connectors ② of the bobbin winder ① to the main PCB.
2. Attach the bobbin winder ① with the 5 screws ① and 1 screw ②.

**\*Key point**

- Refer to "Bobbin winder unit" on page 3 - 14 for the assembly procedure.

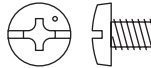
①		Screw, Bind M4X5	Torque 0.79 – 1.18 N·m
②		Screw, Bind M4X6	Torque 0.79 – 1.18 N·m

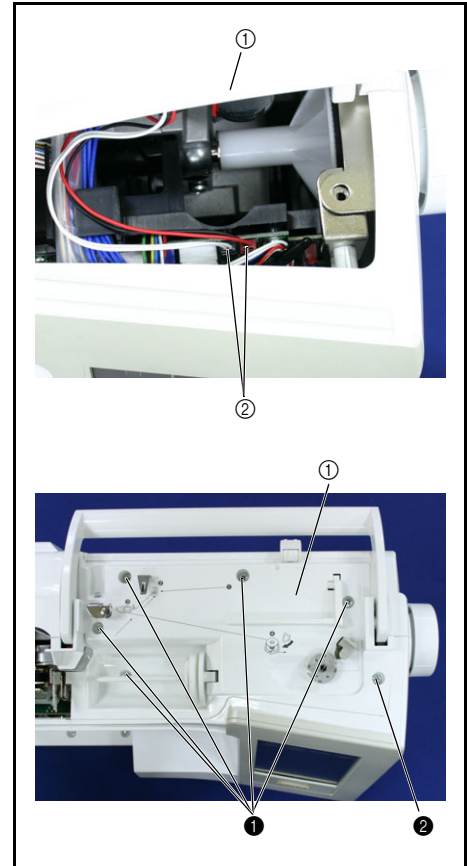

### 24 Base plate cover attachment

1. Attach the base plate cover ① to the base plate with the 2 screws ①.

**\*Key point**

- Hang the 4 hooks of the base plate cover over the base plate, and then slide the base plate cover to the right.

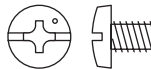
①		Screw, Bind M4X6	Torque 0.79 – 1.18 N·m
---	---	---------------------	---------------------------

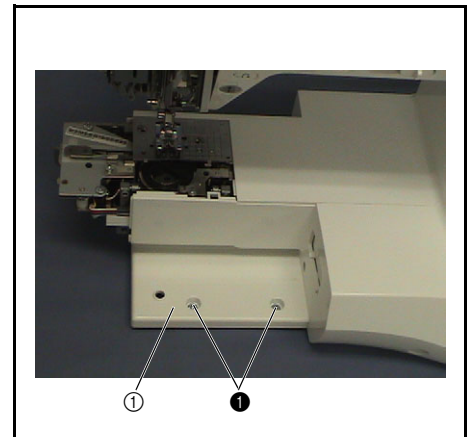

### 25 Free arm cover attachment

1. Attach the free arm cover ① to the arm bed with the screw ①.

**\*Key point**

- Tighten the screw ① from the rear of the cover.
- Hang the hook of the free arm cover over the front cover.

①		Screw, Pan (S/P washer) M4X8F	Torque 0.79 – 1.18 N·m
---	---	----------------------------------	---------------------------

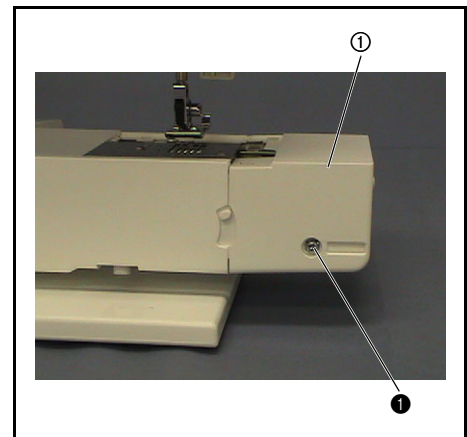



## 26 Front thread guide cover attachment

1. Attach the front thread guide cover ① to the thread guard with the screw ①.

### \*Key point

- Engage the thread guide of the thread guard with the groove on the right side of the front thread guide cover.

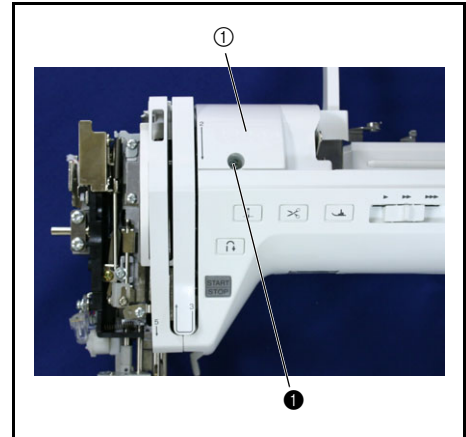

①		Screw, Pan (S/P washer) M3X6DB	Torque 0.58 – 0.78 N·m
---	---	-----------------------------------	---------------------------



## 27 Face plate ASS assembly

1. Attach the needle thread lever slider ② to the needle thread lever assembly ① with the 2 screws ①.
2. Place the needle thread lever assembly ① and the rubber washer ④ onto the needle thread lever shaft ③, and attach these to the face plate ⑤.
3. Attach the shaft presser plate ⑥ with the screw ②.
4. Attach the washer ⑦ with the screw ③.
5. Attach the spring S67.
6. Position the NT lower thread cutter ⑧ and secure it with the retaining ring (CS4).
7. Attach the needle thread lever knob ⑨.
8. Apply a light covering of OILER to the needle thread lever shaft ③.

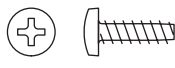
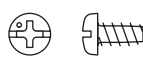
Apply OILER B ASSY to the needle thread lever shaft.	light covering XZ0206***
--	-----------------------------

①		Screw, Pan (S/P washer) M3X7	Torque 0.78 – 1.18 N·m
②		Tapite, Bind B M3X10	Torque 0.58 – 0.78 N·m
③		Tapite, Pan B M3X6	Torque 0.58 – 0.78 N·m
S67		THREAD THROUGH LEVER SPRING XC9388***	

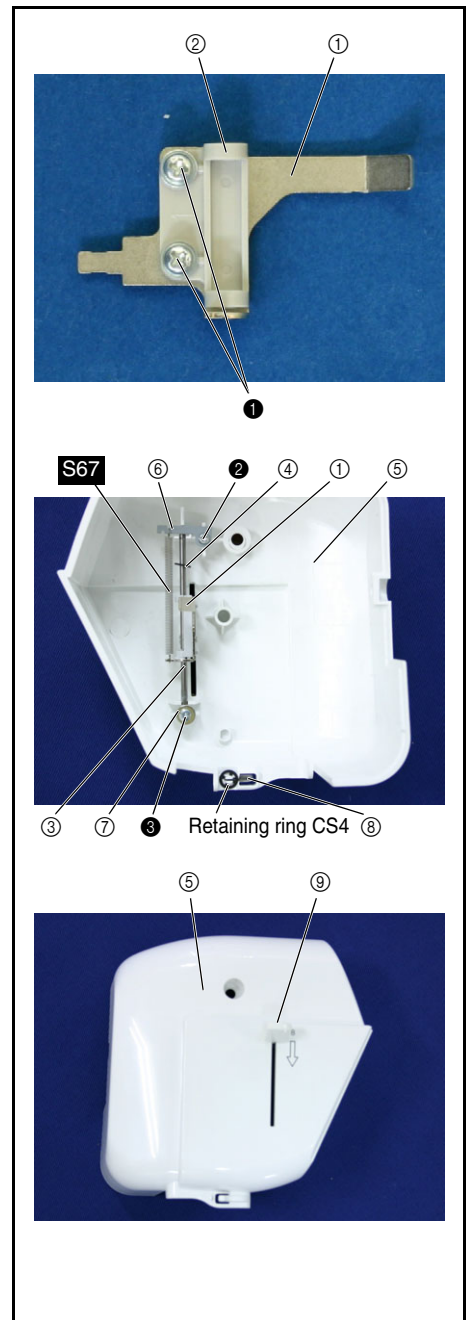



## 28 Face plate assembly attachment

1. Attach the face plate holder ① to the arm bed with the screw ①.
2. Tie the lead wires with a band.
3. Attach the face plate assembly ② with the screws ② and ③.

### \*Key point

- Insert the shaft of the needle-presser module into the positioning hole inside the face plate assembly.
- Move the face plate assembly to the rear cover.

①		Tapite, Bind B M4X10	Torque 1.47 – 1.98 N·m
②		Screw, Pan (S/P washer) M4X8	Torque 0.78 – 1.18 N·m
③		Screw, Pan (S/P washer) M4X12F	Torque 0.78 – 1.18 N·m

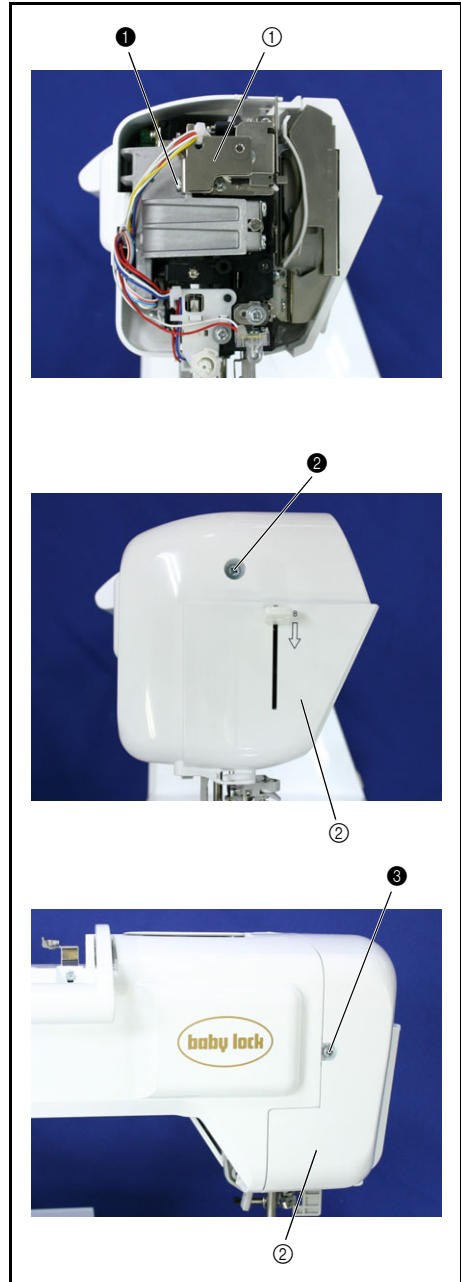

### 29 Needle plate B ASSY assembly

1. Attach the slide button ① to needle plate B ②.
2. Attach the NT lower thread cutter ③ to the cutter cover ④.
3. Insert the plate spring ⑤, and secure the NT lower thread cutter ③.
4. Attach the cutter cover ④ to needle plate B ②.

**\*Key point**

- Insert the lower section of the cutter cover to needle plate B to attach the cutter cover.

5. Attach the needle plate cover ⑥ to needle plate B ②.

**\*Key point**

- Insert the tab on the left side of the needle plate cover ⑥ below the cutter cover ④ (metal section), and then attach the right side of the needle plate cover ⑥.

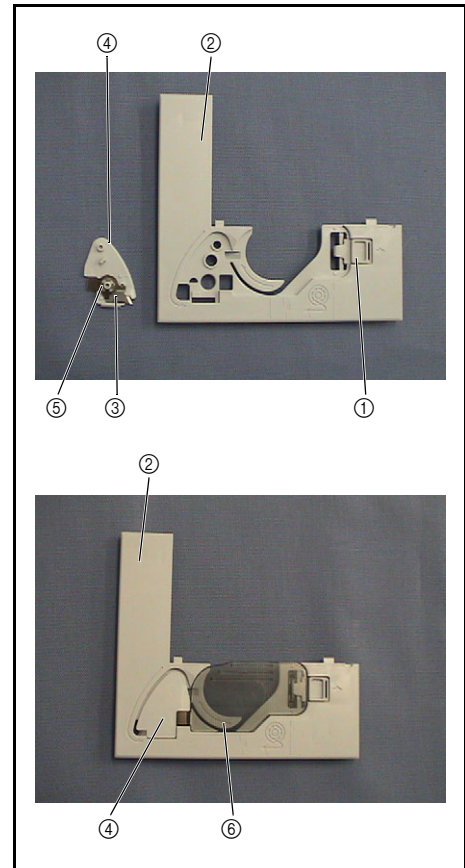

### 30 Needle plate B assembly attachment

1. Side the needle plate B assembly ① into the needle plate A ②.

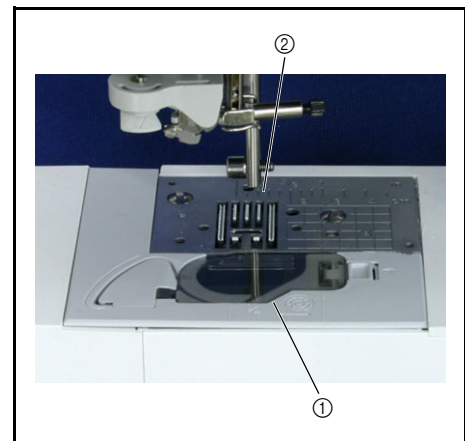

### 31 Top cover attachment

1. Engage the tab ② on the left of the top cover ① with the top cover attachment hole.
2. Press the top cover ① to the hinge ③ of the main unit to attach it.

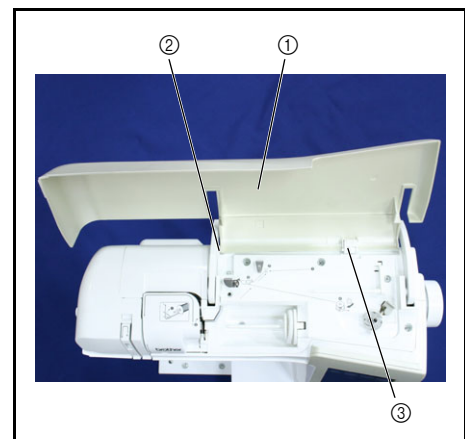

**32** Accessory table attachment

1. Slide the accessory table ① to the right to attach it.



Thread cutter module location diagram

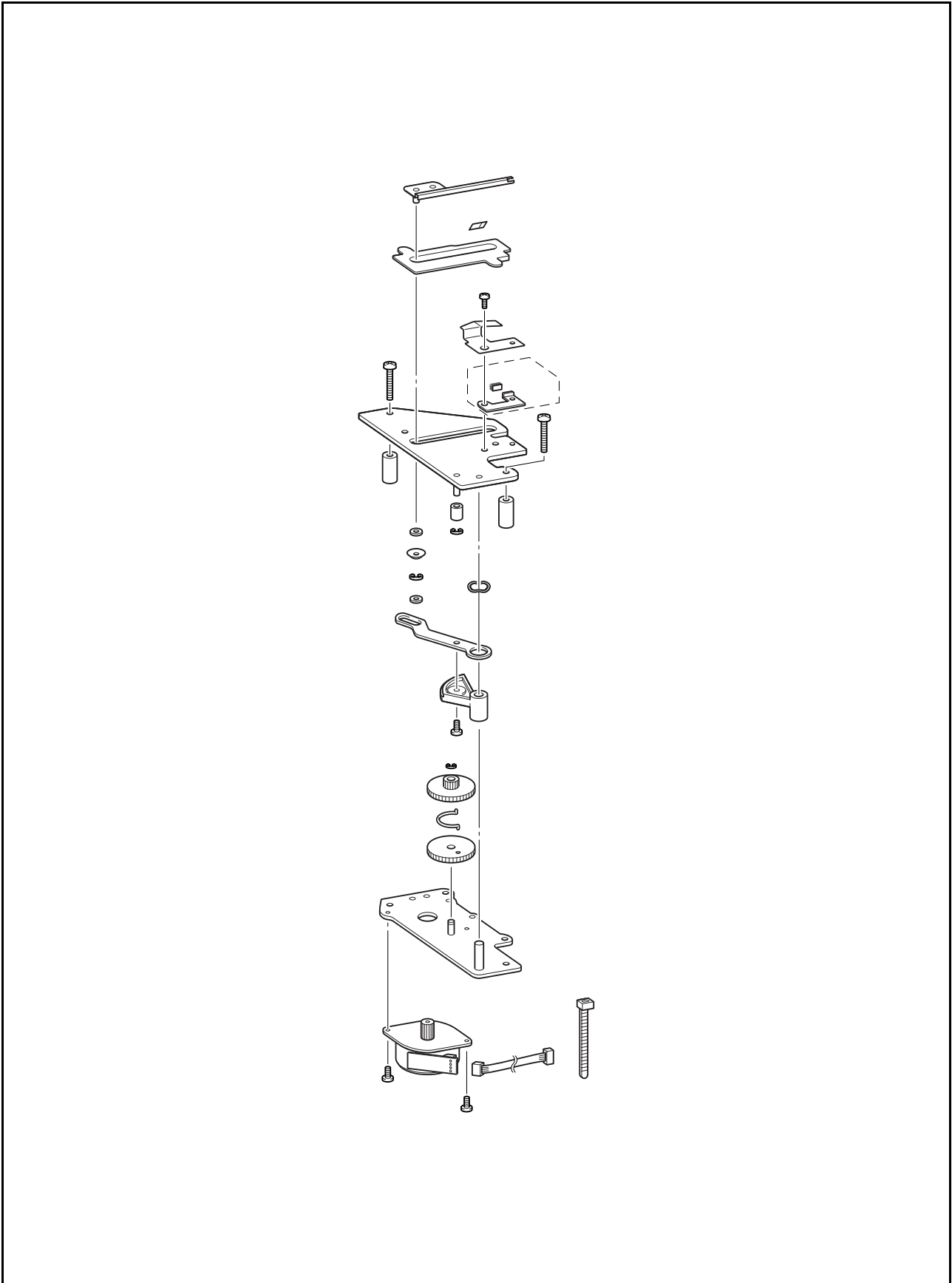

## 1 Z pulse motor assembly attachment

1. Attach the Z pulse motor assembly ① to the motor holder assembly ② with the 2 screws ③.

### \*Key point

- Attach the Z pulse motor assembly ① so that the PCB is at the upper right section.
2. Connect the lead wire connector to the PCB of the Z pulse motor assembly.
  3. Apply 1 or 2 drops of FBK OIL RO 100 to the bushing of the Z pulse motor.

Apply FBK OIL RO 100 to the bushing of the Z pulse motor.
---

1 - 2 drops XC8388***
--------------------------

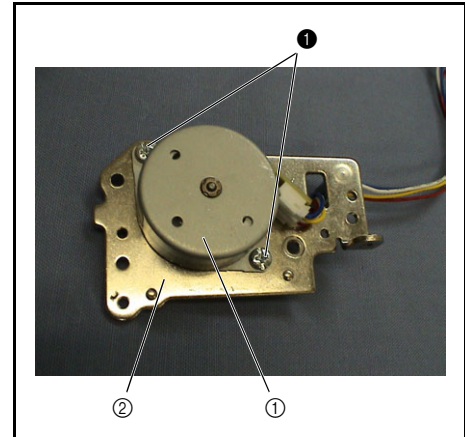

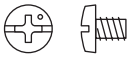
③		Screw, Bind M3X4	Torque
			0.78 – 1.18 N•m



## 2 Idle gears A and B attachment

1. Apply a small amount of EPNOC AP (N)0 to the idle gear shaft ①.
2. Attach the idle gear A ②, spring ③ and idle gear B ④ to the idle gear shaft ①, and attach retaining ring E2.

### \*Key point

- Insert the spring ③ into the small holes ⑤ in the idle gear A ② and the idle gear B ④, and turn the idle gear A ② clockwise until the large holes ⑥ in the idle gear A ② and the idle gear B ④ overlap ⑦.
- With the large holes ⑥ aligned ⑦, align the match mark ⑧ on the idle gear assy. and the match mark ⑨ on the C pulse motor gear, and attach the idle gear shaft ①.

Apply EPNOC AP (N)0 to the lever guide shaft	Small amount XC8387***
--	---------------------------

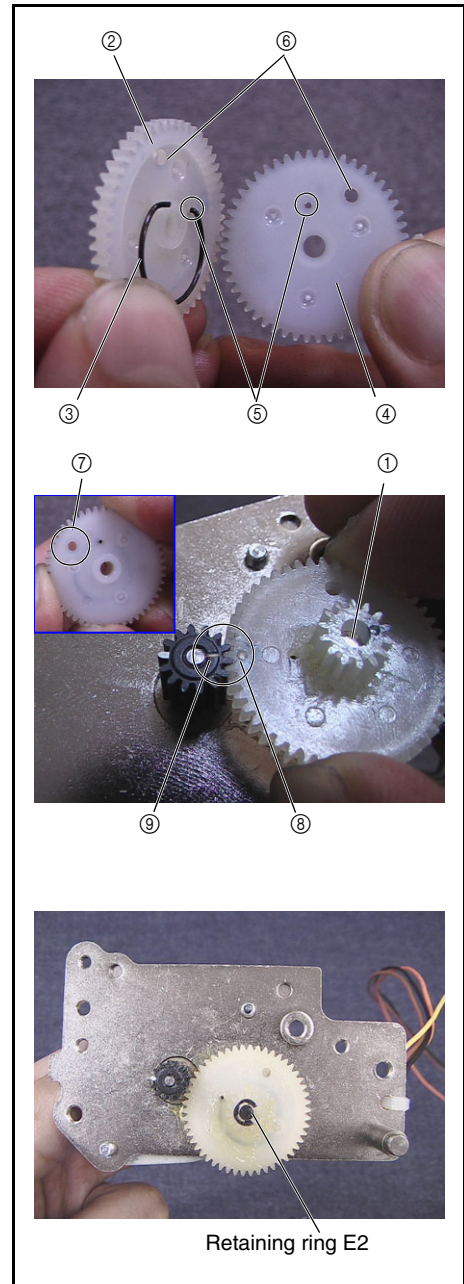

## 3 Photo transistor ASSY assembly

1. Engage the 2 hooks of the sensor holder ② with the photo transistor assembly ①.

### \*Key point

- Position the photo transistor assembly's lead wire to the left when the screw hole on the sensor holder ② is on the right.
- Place the sensor holder ② from the lead wire side of the photo transistor assembly ①.

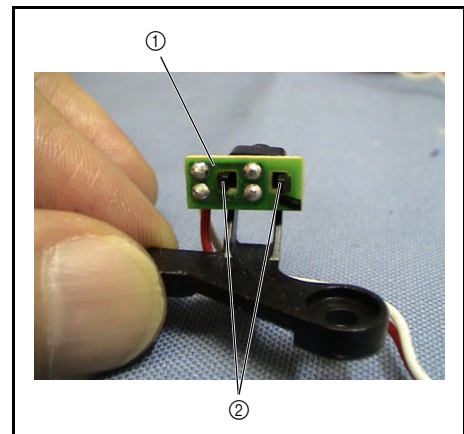

#### 4 Photo transistor assembly attachment

1. Attach the photo transistor assembly ① to the motor holder assembly ② with the screw ①.

**\*Key point**

- Pass the lead wire through the groove ③ on the sensor holder below the photo transistor assembly ①.

①		Screw, Pan (S/P washer) M3X6DA	Torque 0.78 – 1.18 N·m
---	---	-----------------------------------	---------------------------

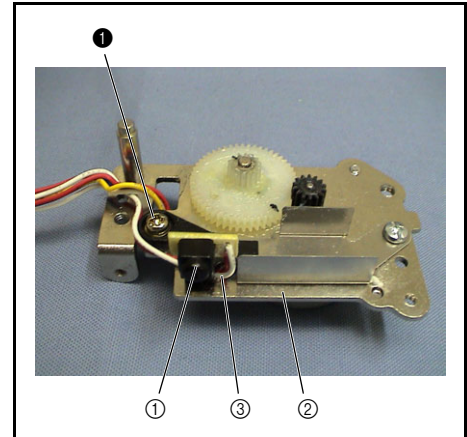

#### 5 Thread cutter lever ASSY assembly

1. Attach the thread cutter lever gear ① to the thread cutter lever ② with the screw ①.

**\*Key point**

- Engage the reverse attachment prevention pin on the rear of the thread cutter lever gear ① with the notch on the thread cutter lever ②.

①		Screw, Pan (S/P washer) M3X6DA	Torque 0.78 – 1.18 N·m
---	---	-----------------------------------	---------------------------

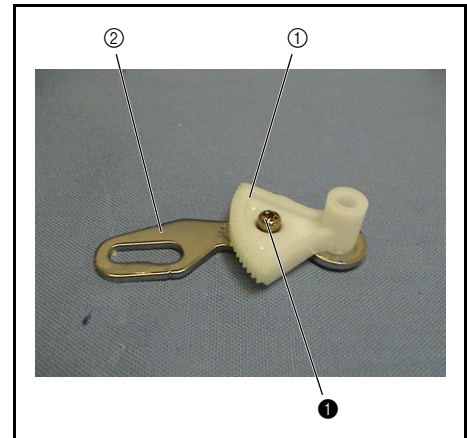

#### 6 Thread cutter lever assembly attachment

1. Apply a small bead of EPNOC AP (N)0 to the thread cutter lever shaft ①.
2. Place the thread cutter lever assembly ② onto the thread cutter lever shaft ①.

**\*Key point**

- Position the thread cutter lever assembly ② so that the thread cutter lever gear ③ is at the lower section.

3. Slide the thread cutter lever assembly ② to engage the thread cutter lever gear ③ with the idle gear ④.

**\*Key point**

- Align the mark (trough) on the thread cutter lever gear ③ with the mark (ridge) on the idle gear ④.

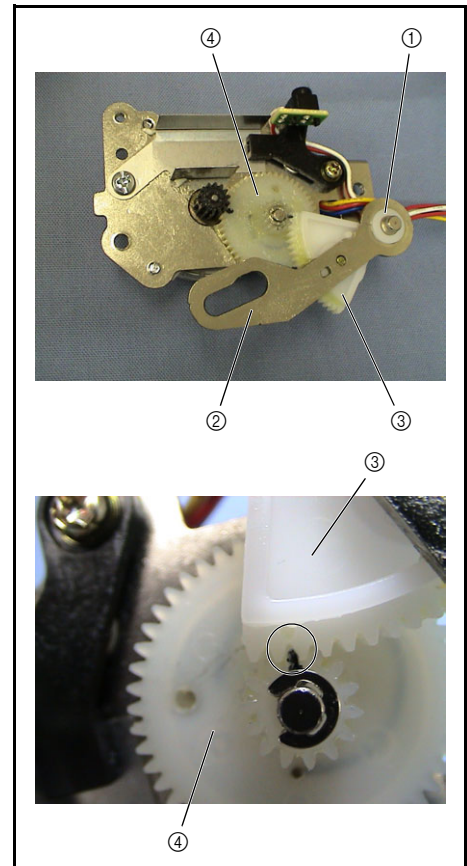

## 7 Rubber attachment

- Place the rubber ① onto the shaft ③ on the rear of the thread cutter frame ②, and then attach the retaining ring (E3).

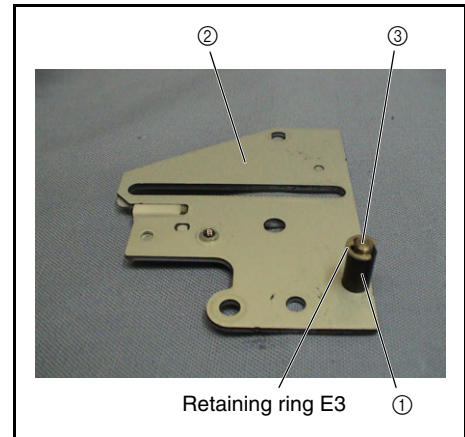

## 8 Thread hook ASSY assembly

- Attach the spacer ① to the thread cutter frame ②.

**\*Key point**

- Engage the 2 positioning tabs on the rear of the spacer ① with the corresponding positioning holes on the thread cutter frame ②.

- Insert the lower thread cutter ③ into the groove on the spacer ①.

**\*Key point**

- Insert the blade ④ of the lower thread cutter ③ in the direction shown in the illustration on the right.

- Attach the thread hook assembly ⑤ to the spacer ①.

**\*Key point**

- Insert the pin ⑥ on the rear of the thread hook assembly into the groove on the spacer ①.
- Cover the lower thread cutter ③ with the thread hook of the thread hook assembly ⑦.

- Place the polyester slider ⑧ and the washer onto the pin ⑥ (longer pin) of the thread hook assembly ⑤ from the rear of the thread cutter frame ②, and then attach the retaining ring (E4).

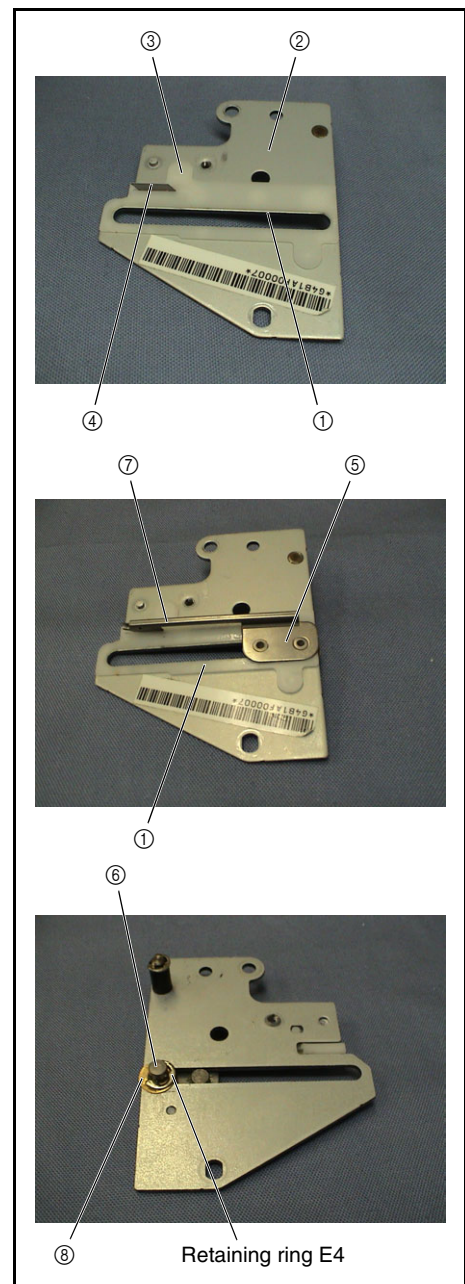

### 9 Presser plate assembly attachment

1. Attach the presser plate ① and the plate spring ② to the thread cutter frame ③ with the screw ④.

**\*Key point**

- Engage the positioning tab on the thread cutter frame ③ with the positioning hole on the presser plate ① and the plate spring ②.

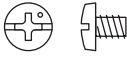
④		Screw, Bind M3X4	Torque 0.78 – 1.18 N·m
---	---	---------------------	---------------------------

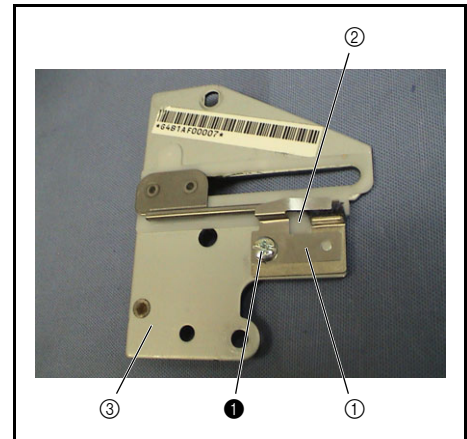

### 10 Grease application

1. Apply a small bead of EPNOC AP (N)0 to idle gears A and B ① and the Z pulse motor gear ②.
2. Apply a small bead of EPNOC AP (N)0 to the engaged face of idle gears A/B ③ and the idle gear ⑤.
3. Apply a small bead of EPNOC AP (N)0 to the slot ⑥ on the thread cutter lever ④.

Apply EPNOC AP (N)0 to idle gears A and B.	Small bead XC8387***
Apply EPNOC AP (N)0 to the engaged face of idle gears A/B.	Small bead XC8387***
Apply EPNOC AP (N)0 to the slot on the thread cutter lever.	Small bead XC8387***

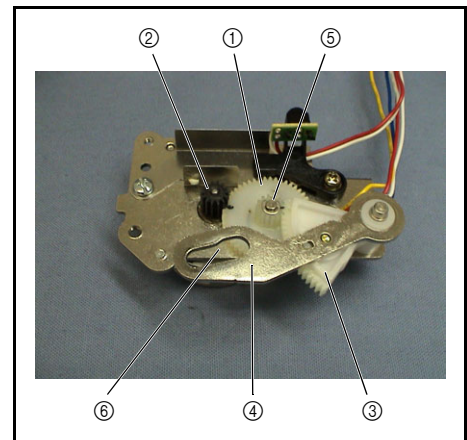

Assembly



## 11 Thread cutter frame assembly attachment

1. Insert the 2 collars ③ between the thread cutter frame assembly ① and the motor holder assembly ②.

**\*Key point**

- Insert the collars ③ into the screw holes.

2. Attach the thread cutter frame assembly ① to the motor holder assembly ② with the 2 screws ①.

**\*Key point**

- Pass the lead wire between the thread cutter lever shaft ④ and the collar ③.
- Thread the 2 screws ① through the collar ③, and then tighten them.
- Engage the positioning hole on the thread cutter lever shaft ④ with that on the thread cutter frame assembly ⑤.
- Insert the pin of the thread hook assembly ⑥ on the rear of the thread cutter frame assembly ① into the slot on the thread cutter lever ⑦.

3. Tie the lead wires with a band ⑧.

**\*Key point**

- Refer to "Wiring procedures".

①		Screw, Bind M4X20	Torque 1.18 – 1.57 N·m
---	---	----------------------	---------------------------

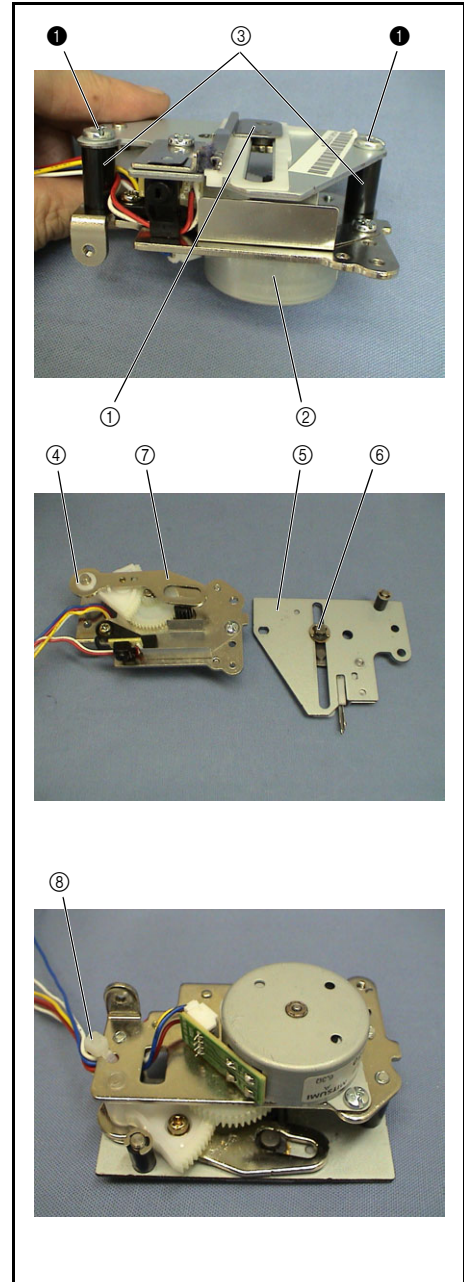

Side feed module location diagram

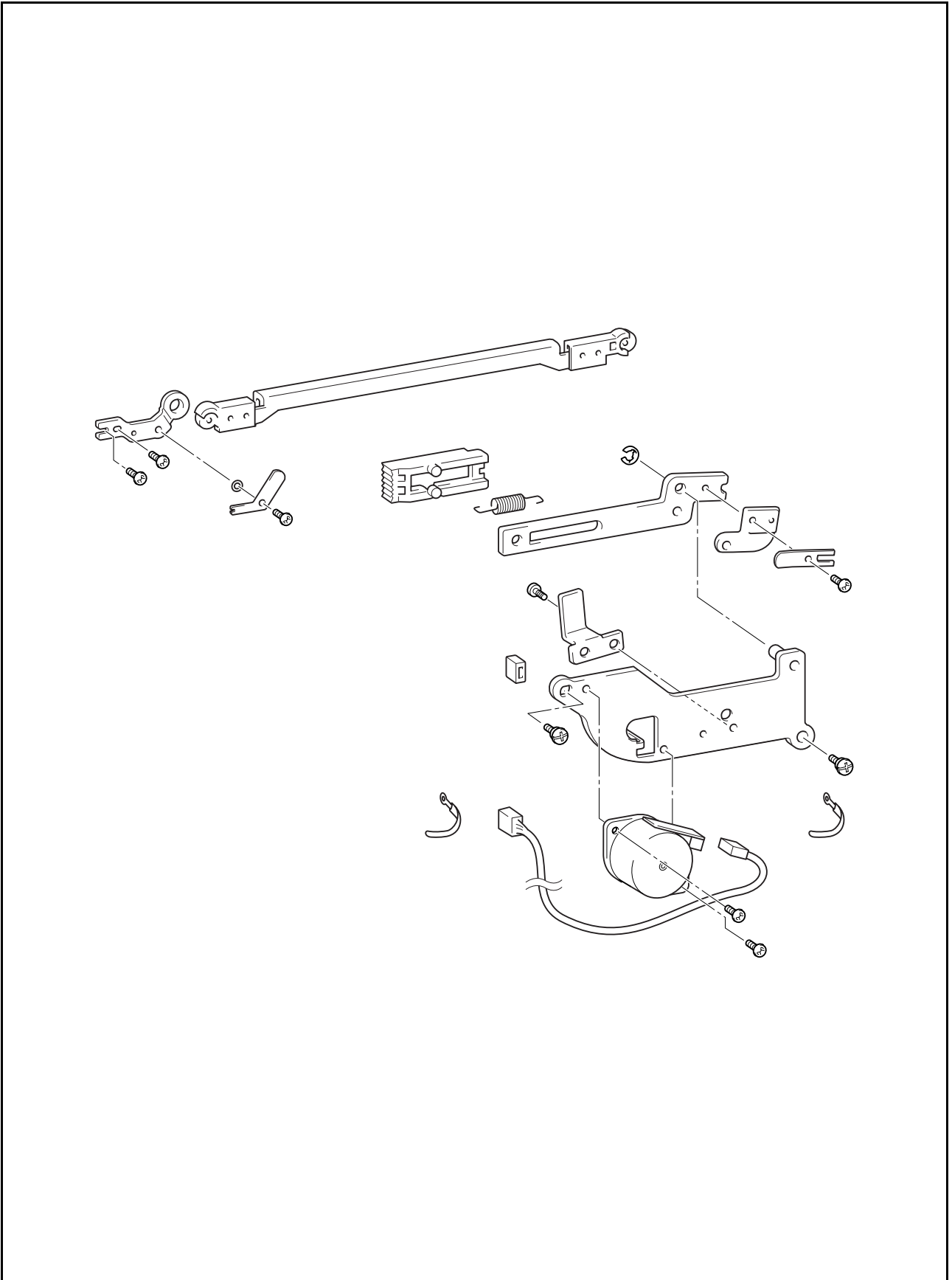



### 1 S pulse motor attachment

1. Attach the S pulse motor assembly ① to the S pulse motor holder ② with the 2 screws ①.
- \*Key point**
- Position the S pulse motor assembly ① so that the PCB is at the upper right section.
2. Connect the lead wire connector to the PCB of the S pulse motor assembly ①.
  3. Apply 1 or 2 drops of FBK OIL RO 100 to the S pulse motor bushing.

Apply FBK OIL RO 100 to the S pulse motor bushing.		1 - 2 drops XC8388***
①		Screw, Bind M3X4  Torque 0.79 – 1.18 N·m

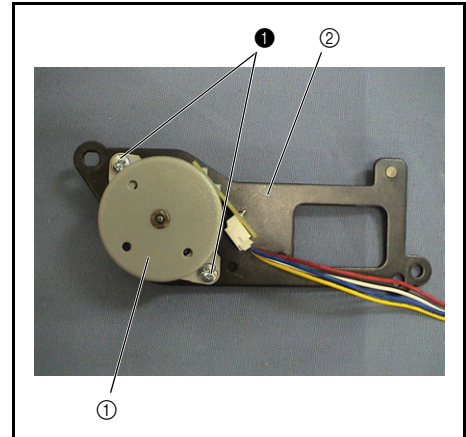

### 2 Side feed gear attachment

1. Place the side feed washer ① onto the calking shaft ③ of the S pulse motor holder assembly ②.
2. Attach one end of the spring S41 to the side feed gear ⑤, and then insert the side feed gear ⑤ into the side feed plate ④.

- \*Key point**
- Engage the tab at the end of the side feed washer ① with the notch on the end of the side feed plate ④.

3. Attach the other end of the spring S41 to the side feed plate ④.

- \*Key point**
- Attach the spring S41 end on the side feed plate side to the round hole, and the end on the S feed gear side to the spring hook.

4. Engage the side feed gear ⑤ with the S pulse motor gear ⑥.

- \*Key point**
- Align the mark ⑧ on the side feed gear ⑤ with the mark ⑦ on the S pulse motor gear ⑥.

5. Attach the S stopper ⑨ to the S pulse motor holder assembly with the screw ①.

- \*Key point**
- Engage the positioning tab on the S pulse motor holder assembly with the positioning hole on the S stopper.

6. Attach the rubber ⑩ to the rubber attachment section of the S pulse motor holder assembly ②.

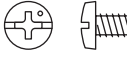
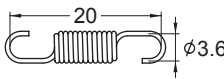
①		Screw, Bind M3X6  Torque 0.79 – 1.18 N·m
S41		SPRING, EXTENSION XA9508***

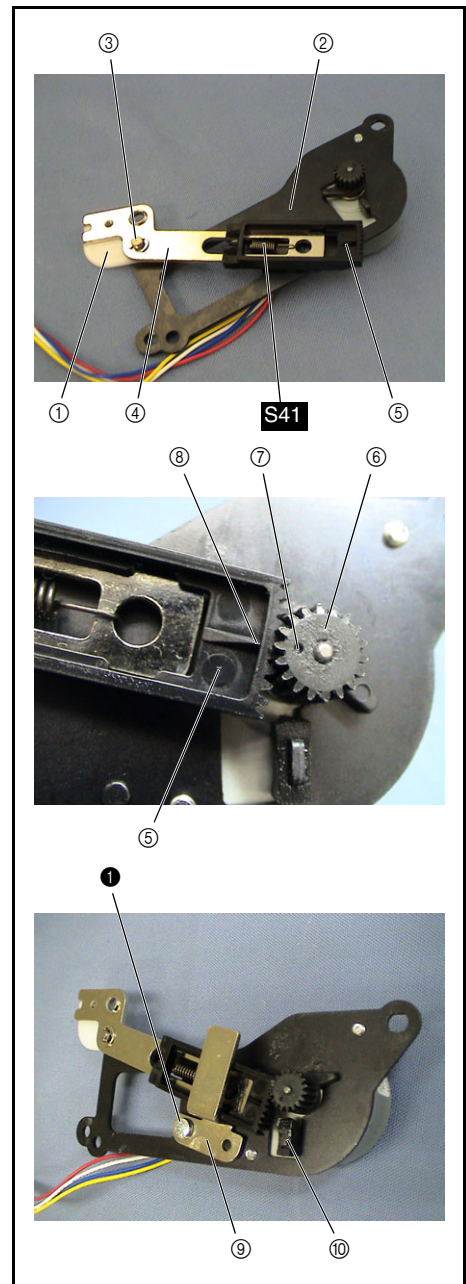

### 3 Side feed adjust plate attachment

1. Apply a bead of MOLYKOTE EM-30L to the shaft hole on the edge of the side feed adjust plate ①.
2. Attach the plate spring B ② and then the washer ③ to the screw ①.
3. Insert the shaft on the rear of the side feed arm assembly ⑤ into the shaft hole ④ on the side feed adjust plate ① and hold them in place by hand, and then tighten the screw ①.

**\*Key point**

- Tighten the screw ① after the plate spring B ② and the washer have been attached.
- Engage the positioning tab on the side feed adjust plate ① with the notch on the plate spring B ②.

Apply MOLYKOTE EM-30L to the shaft hole on the edge of the side feed adjust plate.	Bead
--	------

① 	Screw, Bind M3X5	Torque 0.79 – 1.18 N·m
---	---------------------	---------------------------

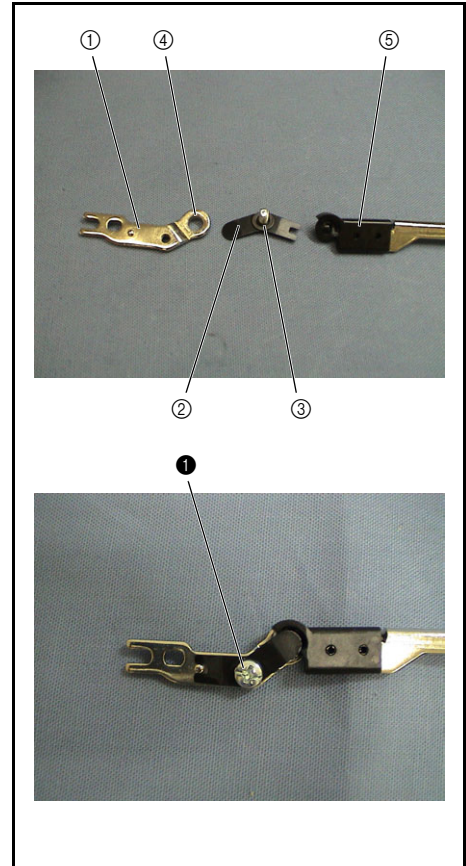

Assembly

### 4 Side feed arm assembly attachment

1. Apply a bead of MOLYKOTE EM-30L to the shaft hole on the side feed plate ①.
2. Attach the plate spring A ② to the screw ①.
3. Insert the shaft of the side feed arm assembly ③ into the shaft hole on the side feed plate ① and hold them in place by hand, and then tighten the screw ①.

**\*Key point**

- Tighten the screw ① after the plate spring A ② has been attached.
- Engage the positioning tab on the side feed washer with the notch on the plate spring A ②.

Apply MOLYKOTE EM-30L to the shaft hole on the side feed plate.	Bead
---	------

① 	Screw, Bind M3X6	Torque 0.79 – 1.18 N·m
---	---------------------	---------------------------

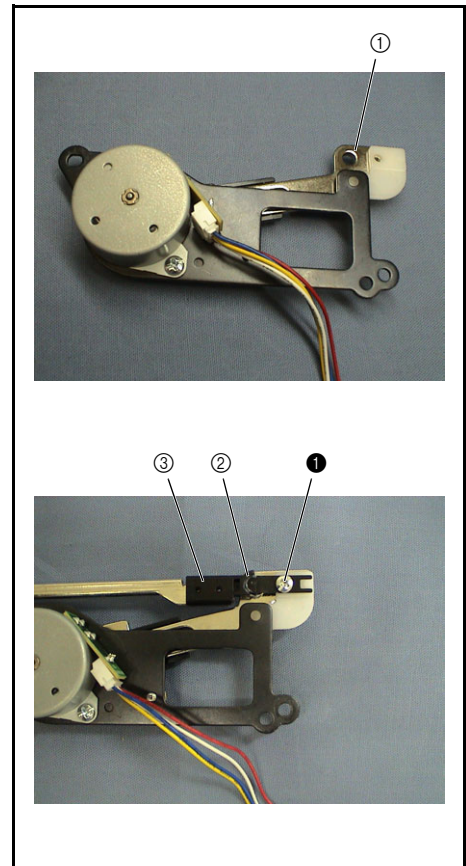



### 1 Bushing presser B attachment

1. Attach the lower shaft bushing ① to the bushing supporter assembly ②.
2. Apply 1 or 2 drops of FBK OIL RO 100 to the sphere of the lower shaft bushing ①.
3. Attach the bushing presser B ③ to the bushing supporter assembly ② with the 3 screws ①.

Apply FBK OIL RO 100 to the sphere of the lower shaft bushing.	1 - 2 drops XC8388***
--	--------------------------

①		Screw, Bind M3X5	Torque
			0.78 – 1.18 N·m

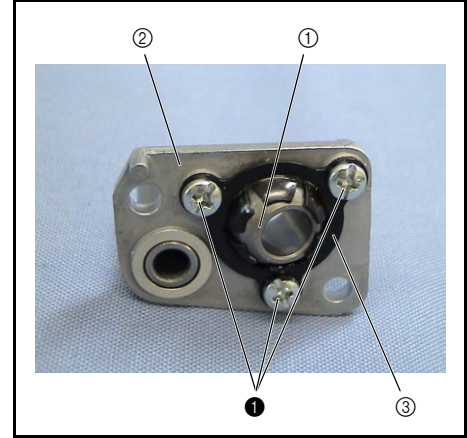

Assembly

### 2 Feed adjuster ASSY assembly

1. Apply a small bead of EPNOC AP (N)0 to the face that contacts the F gear ② of the feed adjuster.
2. Place the F gear ② onto the shaft of the feed adjuster ①.

**\*Key point**

- Position the plane of the F gear ② facing the feed adjuster.

3. Align the gears of the F gear ② in the feed adjuster ①, and then attach the spring S13.
4. Place the polyester slider ③ onto the shaft of the feed adjuster ①.

Apply EPNOC AP (N)0 to the face that contacts the F gear of the feed adjuster.	Small bead XC8387***
--	-------------------------

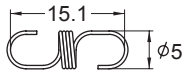
S13		SPRING
		XC2530***

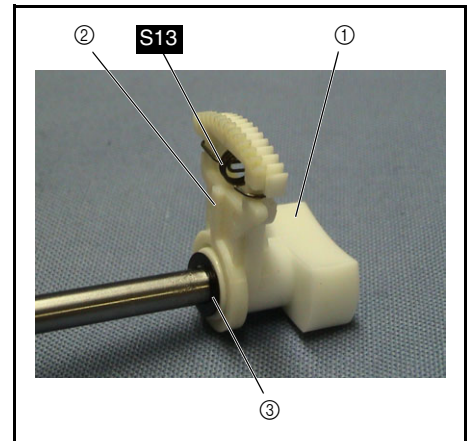



### 3 Feed adjuster assembly attachment

1. Place the spring **S14** onto the shaft of the feed adjuster ①.
  - \*Key point**
    - Place the spring **S14** from the end with the smaller diameter.
2. Apply a small bead of EPNOC AP (N)0 to the shaft of the feed adjuster ①.
3. Insert the shaft of the feed adjuster ① into the bushing supporter assembly ②.
4. Attach the feed adjuster assembly ③ to the inside of the base plate with the 3 screws ①.

**\*Key point**

- Engage the positioning tab on the feed adjuster assembly ③ with the positioning hole on the base plate.
5. Apply a small bead of EPNOC AP (N)0 to the operating section of the rectangular slide ④ of the feed adjuster assembly ③.

Apply EPNOC AP (N)0 to the shaft of the feed adjuster.	Small bead XC8387***
Apply EPNOC AP (N)0 to the operating section of the rectangular slide of the feed adjuster assembly.	Small bead XC8387***

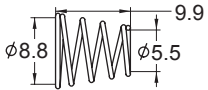
<b>1</b>		Screw, Bind M4X6	Torque 1.18 – 1.57 N·m
<b>S14</b>			SPRING XC2531***

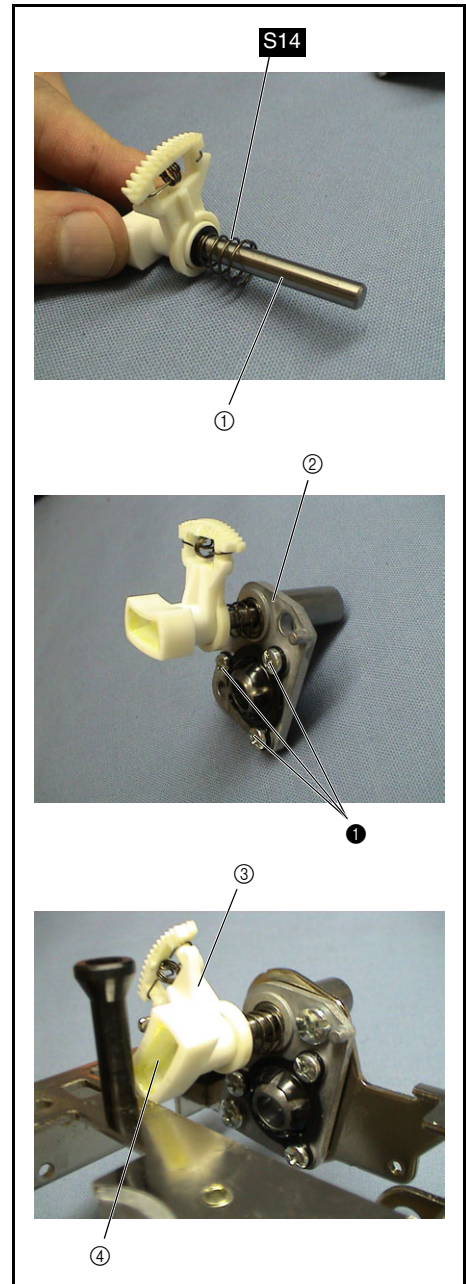

### 4 Drop ASSY assembly

1. Attach the retaining ring (E3) to the outer groove on the vertical feed shaft ①, and then place the polyester slider ② onto the shaft.
2. Insert the vertical feed shaft ① into the right shaft hole on the vertical supporting plate ③.
3. Place the set screw collar ④, vertical lever ⑤, polyester slider ⑥, feed dog correction lever ⑦, and the spring S57 over the vertical feed shaft in this order.
4. Insert the vertical feed shaft ① until it reaches the left shaft hole on the vertical supporting plate ③.
5. Temporarily attach the screw ① to the set screw collar ④.

**\*Key point**

- Perform "Drop assembly adjustment" on page 3 - 73, and then fully tighten the screw ①.

6. Attach the retaining ring (E3) between the vertical supporting plate ③ and the set screw collar ④.

**\*Key point**

- Slide the set screw collar ④ to the left to attach the retaining ring (E3).

7. Apply 1 or 2 drops of MOLYKOTE EM30L to the vertical feed shaft ①.

Apply MOLYKOTE EM30L to the vertical feed shaft.	1 - 2 drops XC8385***
--	--------------------------

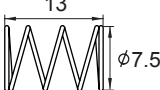
<b>①</b>		Set Screw, Socket (CP) M4X4	Torque Hand tighten
<b>S57</b>		SPRING XC7856***	

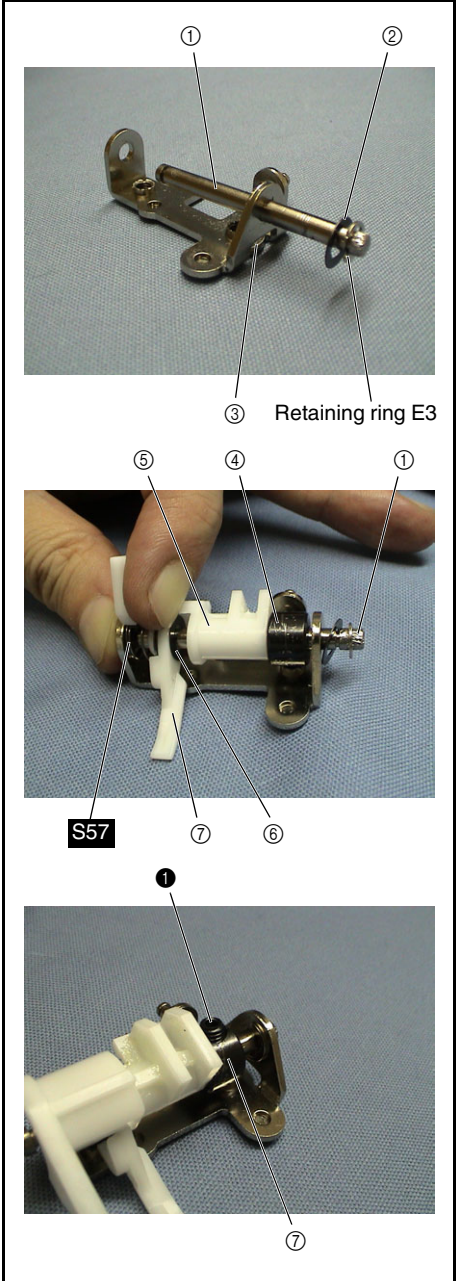

Assembly



## 5 Drop assembly attachment

1. Attach the drop assembly ① to the inside of the base plate with the 2 screws ①.

### \*Key point

- Engage the 2 positioning tabs on the vertical supporting plate of the drop assembly ① with the corresponding positioning holes on the base plate.
- Tighten the 2 screws ① from the upper one.

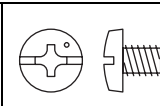
①		Screw, Bind M4X5	Torque 1.18 – 1.57 N·m
---	--	---------------------	---------------------------

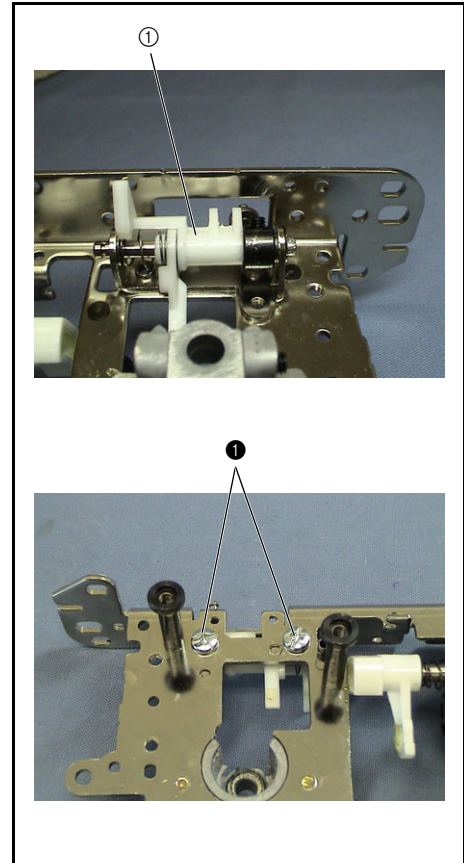

## 6 Stopper plate block attachment

1. Attach the stopper plate block ① to the base plate with the screw ①.

### \*Key point

- Engage the positioning tab on the stopper plate block ① with the positioning hole on the base plate, and then rotate the stopper plate block ① counterclockwise.
- Shift the stopper plate block ① in the direction of the arrow shown in the illustration on the right to eliminate backlash, and then tighten the screw ①.

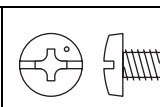
①		Screw, Bind M4X5	Torque 1.18 – 1.57 N·m
---	---	---------------------	---------------------------

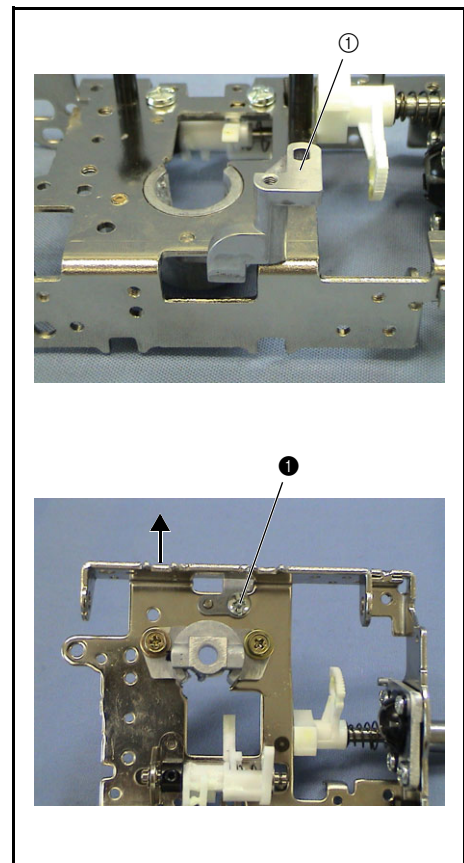

**7 Lower shaft B ASSY assembly**

1. Attach the set screw collar ②, thrust wafer ③, lower shaft bushing ④, and thrust washer ③ to the shorter shaft of the lower shaft B assembly ① in this order, and then attach the retaining ring (E6).

**\*Key point**

- Attach the set screw collar ② with the polished surface facing the left.

2. Secure the set screw collar ② with the 2 screws ①.

**\*Key point**

- Move the set screw collar ② to the lower shaft bushing ④, and then secure it.

3. Apply 1 or 2 drops of FBK OIL RO 100 to the lower shaft bushing ④.

Apply FBK OIL RO 100 to the lower shaft bushing.	1 - 2 drops XC8388***
--	--------------------------

①		Set Screw, Socket (CP) M4X4	Torque 0.78 – 1.18 N·m
---	---	--------------------------------	---------------------------

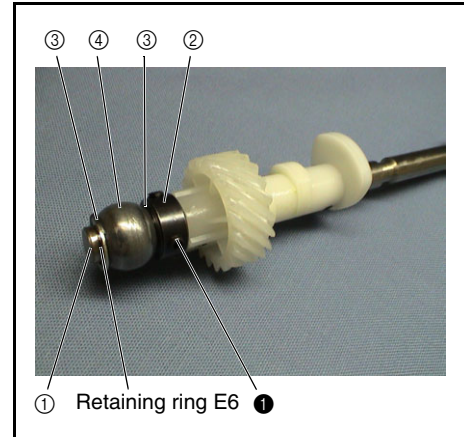

### 8 Lower shaft B assembly attachment

1. Attach the bushing supporter A ① to the base plate.

**\*Key point**

- Engage the 2 positioning tabs on the bushing supporter A ① with the corresponding positioning holes on the base plate.

2. Apply 1 or 2 drops of FBK OIL RO 100 to the lower shaft B ③ (section to be inserted into the bushing supporter B ④) of the lower shaft B assembly ②.

3. Insert the lower shaft B ③ of the lower shaft B assembly ② into the bushing supporter B ④.

**\*Key point**

- Slightly lift the left end of the lower shaft B assembly ② when inserting the shaft.

4. Place the lower shaft bushing ⑤ of the lower shaft B assembly ② onto the bushing supporter A ①.

5. Attach the bushing presser A ⑥ to the lower shaft bushing ⑤ with the 2 screws ①.

6. Attach the joint ⑦ to the lower shaft B ③ with the 2 screws ②.

**\*Key point**

- Align the screw hole on the joint with the D-cut face on the lower shaft B ③.



**NOTE**

- Rotate the joint to check the rotation torque.
- If the rotation torque is heavy, tap the bushing with a brass bar.

Apply FBK OIL RO 100 to lower shaft B (section to be inserted into bushing supporter B) of the lower shaft B assembly.

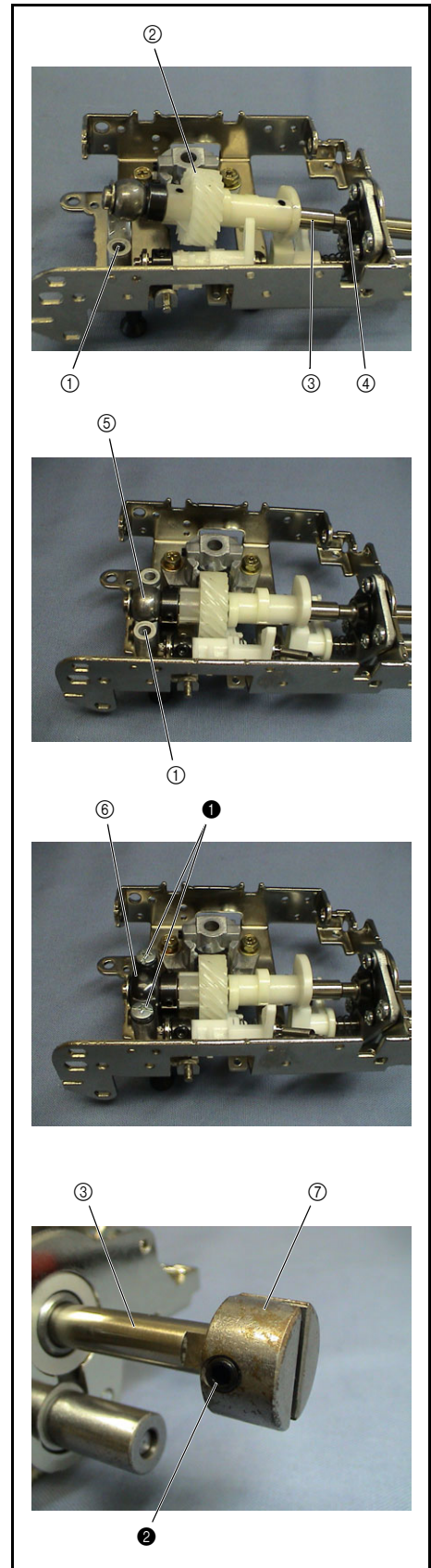
1 - 2 drops XC8388\*\*\*

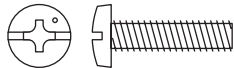

①		Screw, Bind M4X16	Torque 1.18 – 1.57 N·m
②		Set Screw, Socket (FT) M5X5	Torque 1.18 – 1.57 N·m



### 9 Drop assembly adjustment

1. Loosen the screw ❶ to free the set screw collar ❶, and then move the vertical lever ❷.

**\*Key point**

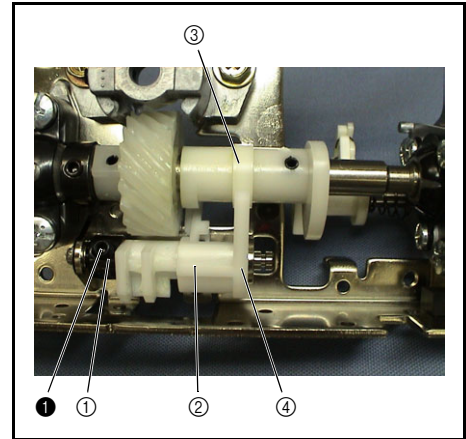
- Move the vertical lever ❷ until the cam contact section ❸ of the vertical lever ❷ is directly above the vertical feed cam ❸ of the lower shaft B assembly.
2. Move the set screw collar ❶ to the vertical lever ❷, and then secure the set screw collar ❶ with the screw ❶.



❶	 	Set Screw, Socket (CP) M4X4	Torque 1.18 – 1.57 N·m
---	---	--------------------------------	---------------------------

### 10 Grease application

1. Apply a bead of EPNOC AP (N)0 to the horizontal feed cam ❶ of the lower shaft B assembly.
2. Apply a bead of EPNOC AP (N)0 to the vertical feed cam ❷ of the lower shaft B assembly.
3. Apply a bead of EPNOC AP (N)0 to the circumference of the lower shaft gear ❸ of the lower shaft B assembly.

Apply EPNOC AP (N)0 to the horizontal feed cam of the lower shaft B assembly.	Bead XC8387***
Apply EPNOC AP (N)0 to the vertical feed cam of the lower shaft B assembly.	Bead XC8387***
Apply EPNOC AP (N)0 to the circumference of the lower shaft gear of the lower shaft B assembly.	Bead XC8387***

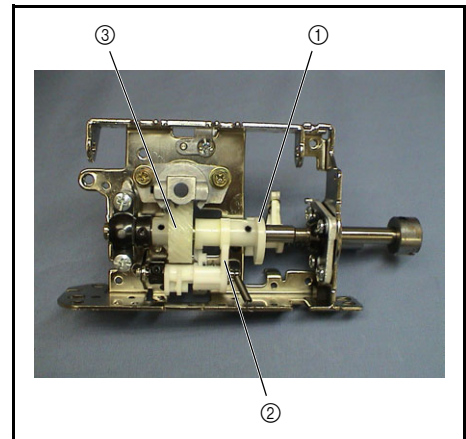

**11 Feed arm ASSY assembly**

1. Apply 1 or 2 drops of FBK OIL RO 100 to the shaft ② of the feed supporting plate assembly ①.
2. Place the feed arm B assembly ③ onto the shaft ② of the feed supporting plate assembly ①, and then attach the retaining ring (E2).
3. Apply 1 or 2 drops of FBK OIL RO 100 to the shaft ④ of the feed arm B assembly ③.
4. Insert the shaft ④ of the feed arm B assembly ③ into the shaft hole on the feed arm A ⑤.
5. Place the polyester slider ⑥ onto the shaft ④ of the feed arm B assembly ③ from the outside of the feed arm A ⑤, and then attach the retaining ring (E3).

Apply FBK OIL RO 100 to the shaft of the feed supporting plate assembly.	1 - 2 drops XC8388***
Apply FBK OIL RO 100 to the shaft of the feed arm B assembly.	1 - 2 drops XC8388***

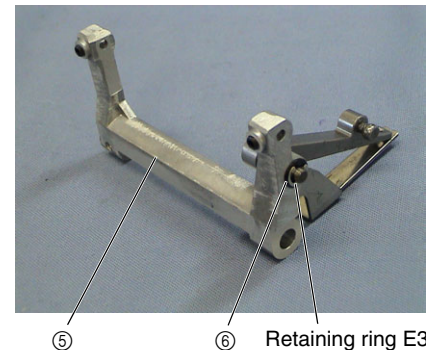
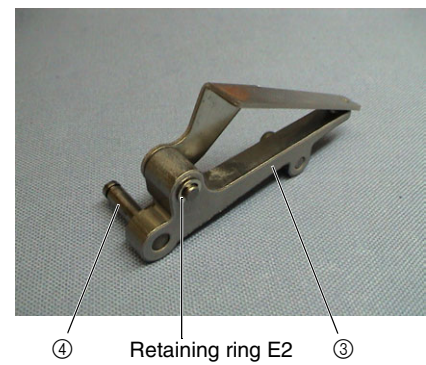
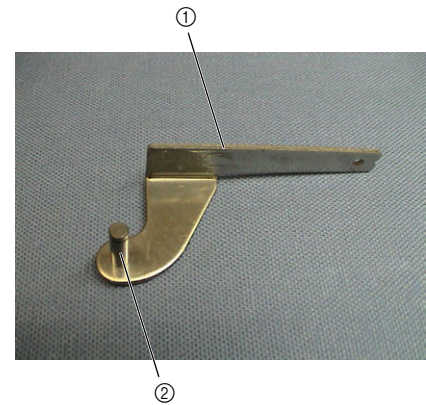



## 12 Feed arm assembly attachment

1. Insert the feed arm assembly ① from the bottom.

### \*Key point

- Insert the feed rectangular side shaft ③ of the feed arm B ② into the feed adjuster ④ on the top side.
2. Place the thrust washer ⑤ between the left base plate and the feed arm A.
  3. Insert the grooved end of the horizontal feed shaft ⑥ from the left base plate.
  4. Pass the horizontal feed shaft ⑥ through to the left feed arm A.
  5. Place the thrust washer ⑤ between the right feed arm A and the base plate.
  6. Pass the horizontal feed shaft ⑥ through to the right base plate.
  7. Attach the retaining ring (E5) between the right feed arm A and the base plate.

### \*Key point

- Move the retaining ring (E5) to the feed arm A so that it can secure the thrust washer ⑤.
8. Apply 1 or 2 drops of OILER B ASSY to the 2 sections ⑥ where the horizontal feed shaft is inserted in the feed arm A.

Apply OILER B ASSY to the 2 sections where the horizontal feed shaft is inserted in the feed arm A.
---

1 - 2 drops each XZ0206***
-------------------------------

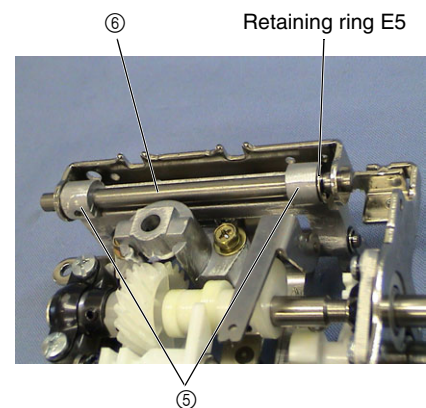
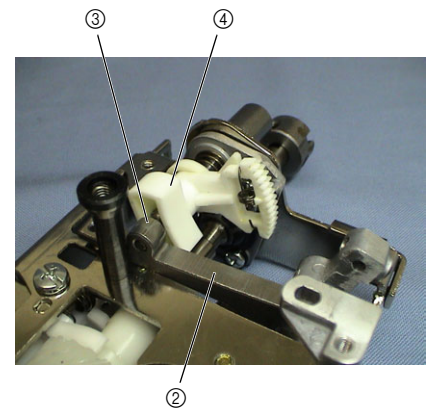
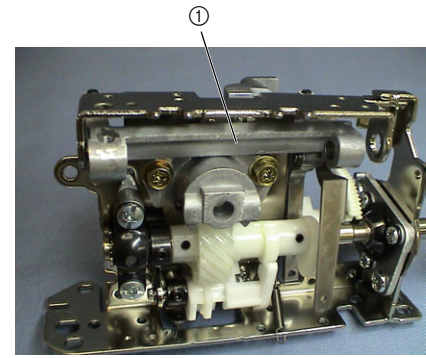



## 13 Set screw collar attachment

1. Attach the set screw collar ① to the horizontal feed shaft ② with the screw ①.

### \*Key point

- Move the horizontal feed shaft ② in the direction of the set screw collar ① to eliminate backlash, and then press the set screw collar ① to the base plate.

①	 	Set Screw, Socket (CP) M4X4	Torque 1.18 – 1.57 N·m
---	---	--------------------------------	---------------------------

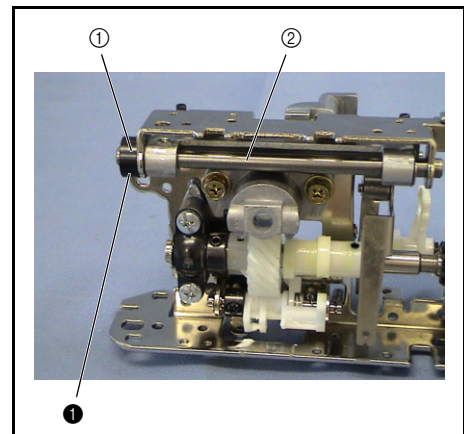



### 14 Shaft stopper plate attachment

1. Attach the shaft support plate ① to the base plate with the screw ①.

**\*Key point**

- Engage the positioning tab on the shaft support plate ① with the positioning hole on the base plate.

<b>①</b>		Screw, Bind M3X5	Torque 1.18 – 1.57 N·m
----------	---	---------------------	---------------------------

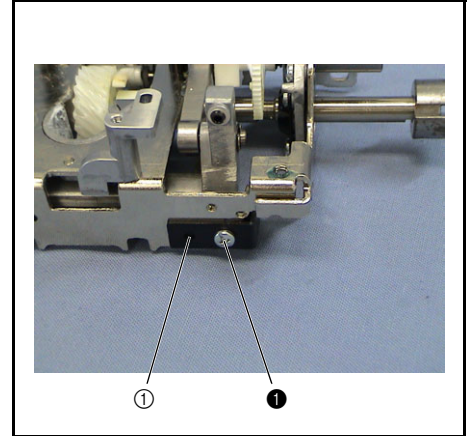

### 15 Spring attachment

1. Attach the spring **S37** to the feed supporting plate ① and the feed arm B ②.

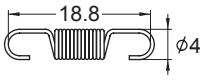
<b>S37</b>		SPRING XZ0174***
------------	---	---------------------

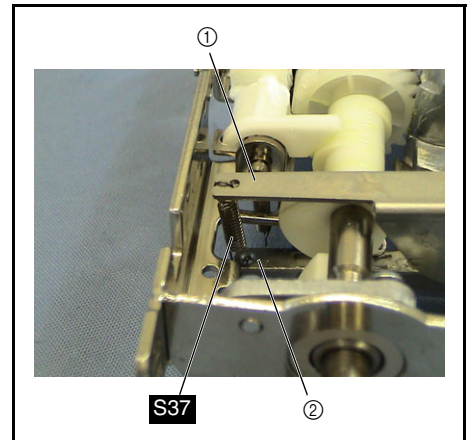

### 16 F pulse motor holder ASSY assembly

1. Place the rubber ③ onto the shaft ② of the F pulse motor holder ①.
2. Attach the pulse motor (M35SP-8N) ④ with the 2 screws ①.
3. Place the F pulse motor lead wire assembly ⑤ in the pulse motor (M35SP-8N) ④.
4. Apply 1 or 2 drops of FBK OIL RO 100 to the bushing ⑥ of the pulse motor (M35SP-8N9).

Apply FBK OIL RO 100 to the bushing of the pulse motor (M35SP-8N9).	1 - 2 drops XC8388***
---	--------------------------

<b>①</b>		Taptite, Bind B M3X5	Torque 0.78 – 1.18 N·m
----------	---	-------------------------	---------------------------

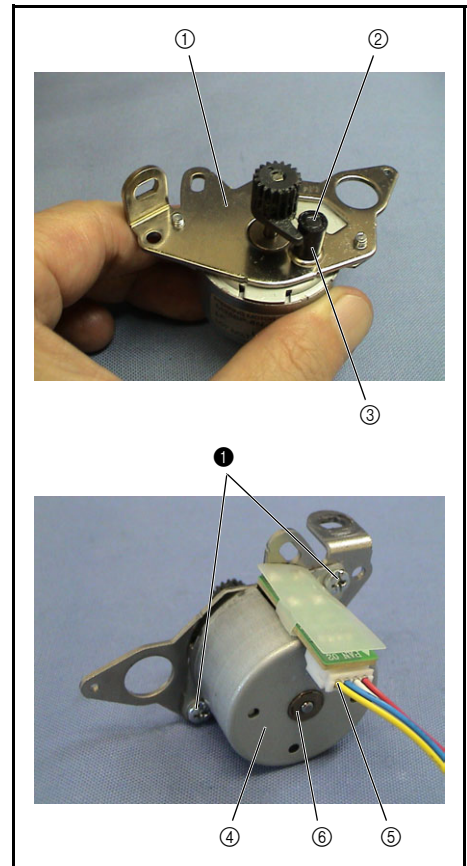

## 17 F pulse motor holder assembly attachment

1. Lift the F gear of the feed adjuster ①.
2. Place the F pulse motor holder assembly ② in the bushing of bushing supporter B ③.
3. Place the spring S15 between the F pulse motor holder ④ and the base plate ⑤, and tighten the screw ①.

### \*Key point



- Move the screw hole to the center of the slot ⑥ on the F pulse motor holder before tightening the screw ①.

4. Temporarily tighten the screw ② in the screw hole visible in the slot.

### \*Key point

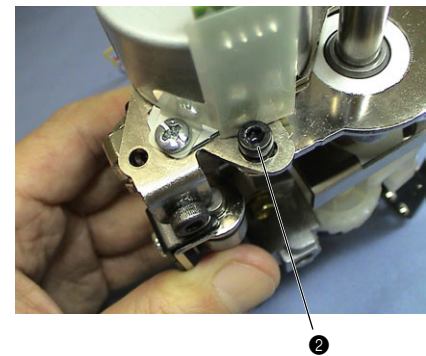
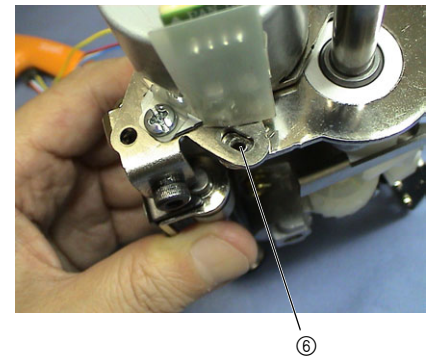
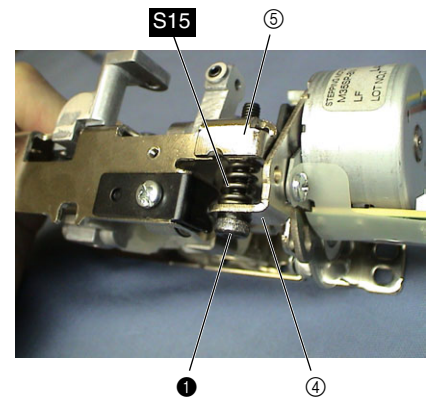
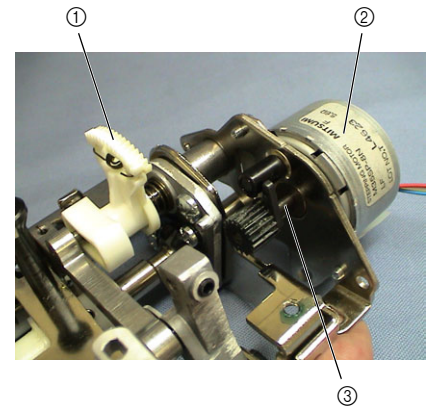
- Adjust forward/backward feed, and then fully tighten the screw ②.
- Refer to "Feed forward/backward adjustment" on page 4 - 22 for the adjustment procedure.

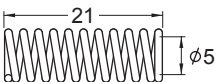

①		Bolt, Socket M4X25	
②		Screw M3X8	Torque 0.29 – 0.49 N·m
S15			SPRING XC2537***

## 18 F gear adjustment

1. Apply a small bead of EPNOC AP (N)0 to the gear surface of the feed adjuster ①.
2. Rotate the gear ④ of the F pulse motor clockwise until the stopper ③ of the F pulse motor contacts the shaft ② (with the rubber mounted).
3. Press the feed adjuster ① until the gear of the feed adjuster ① engages with the gear of the F gear ⑤.
4. Engage these gears with the gear ④ of the F pulse motor

### \*Key point

- Hold the gear ④ of the F pulse motor with your finger to prevent the gear from rotating.
- Align the mark on the feed adjuster gear ⑥ with the mark on the F gear ⑦.

Apply EPNOC AP (N)0 to the gear surface of the feed adjuster.
---

Small bead XC8387***
-------------------------

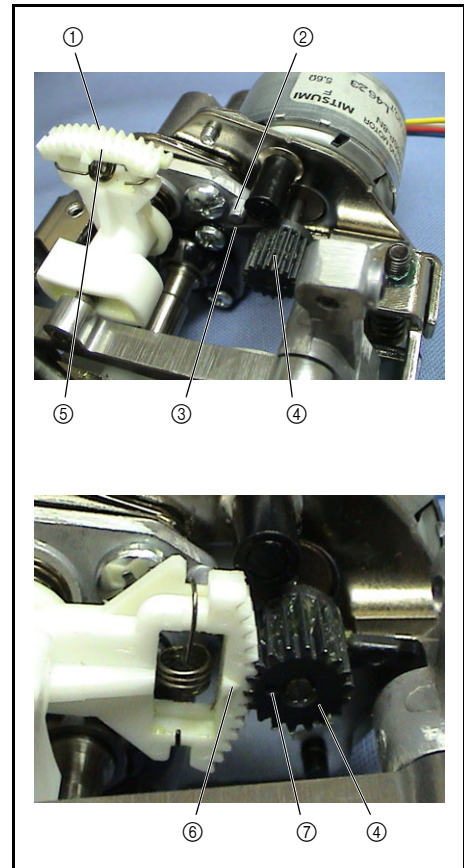

## 19 F gear stopper plate attachment

1. Attach the F gear stopper plate ① to the base plate with the screw ①.

### \*Key point

- Insert the F gear stopper plate ① from the top of the base plate.
- Engage the positioning tab on the F gear stopper plate ① with the positioning hole on the base plate.
- Tighten the screw ① from the bottom of the plate.

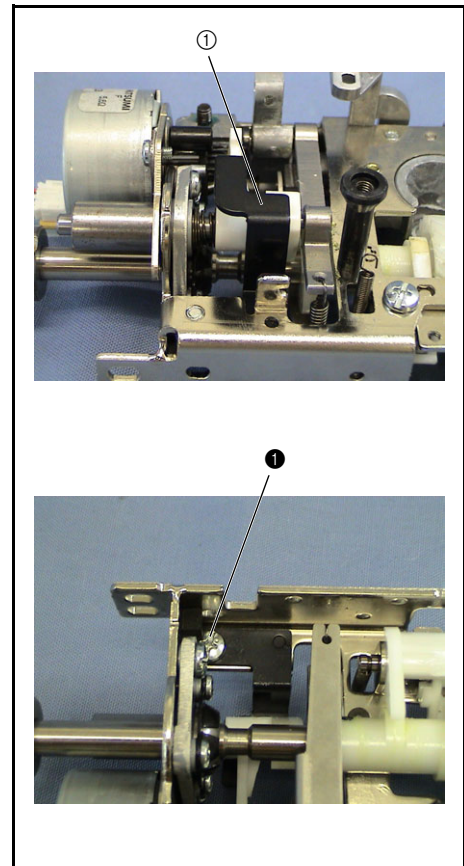

①		Screw, Bind M4X4	Torque 1.18 – 1.57 N•m
---	--	---------------------	---------------------------



### 20 Spring attachment

1. Attach the spring **S16** to the spring holes on the base plate ① and the FPM holder ②.

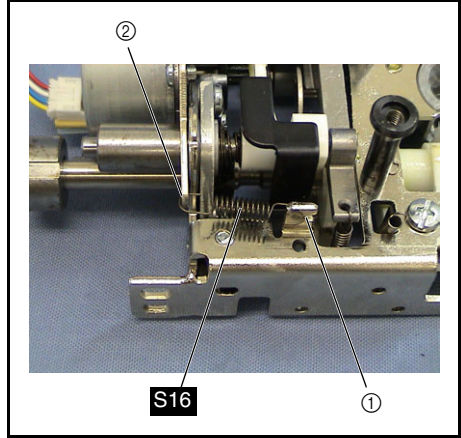
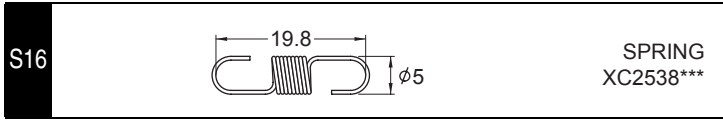

### 21 Vertical feed bush attachment

1. Attach the vertical feed bush ① to the base plate with the 2 screws ①.

**\*Key point**

- Face the cut face of the vertical feed bush inside.

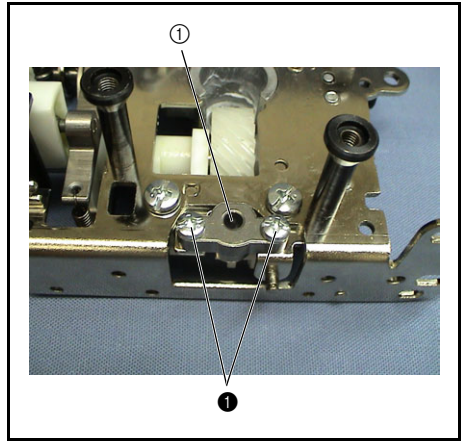
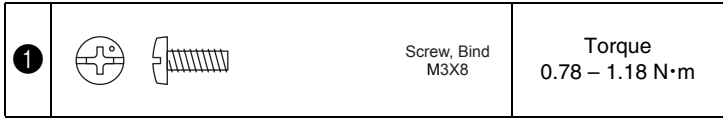

### 22 Vertical rod attachment

1. Apply 1 or 2 drops of OILER B ASSY to the shaft of the vertical rod ①.
2. Insert the vertical rod ① into the vertical feed bush ②.
3. Apply a bead of MOLYKOTE EM30L to the top face of the vertical rod ①.

Apply OILER B ASSY to the shaft of the vertical rod.	1 - 2 drops XZ0206***
Apply MOLYKOTE EM30L to the top face of the vertical rod.	Bead XC8385***

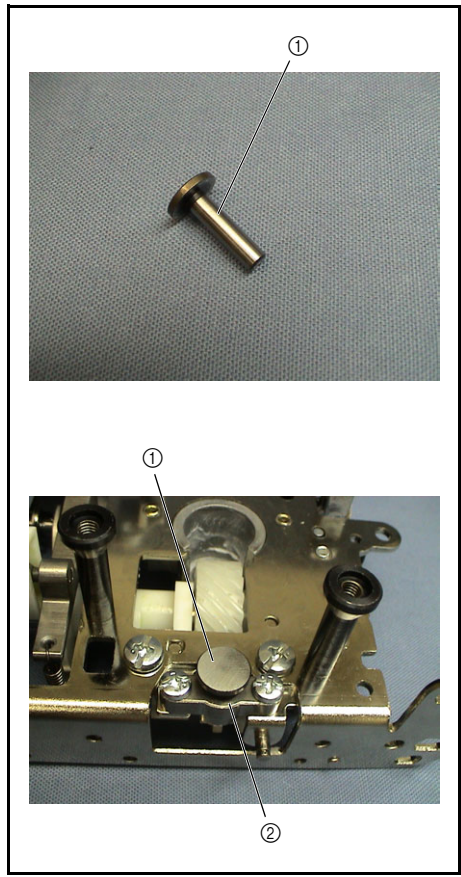

**23** Vertical adjusting screw attachment

1. Attach the M5 nut ② to the vertical adjusting screw ①.

**\*Key point**

- Rotate the M5 nut ② until it is approximately 1.5 mm from the top end of the vertical adjusting screw ①.

2. Attach the vertical adjusting screw ① to the feed bar ③.

**\*Key point**

- Tighten the vertical adjusting screw ① until the bottom of the M5 nut ② reaches the feed bar ③.

3. Attach the cap ④ to the bottom of the vertical adjusting screw ①.

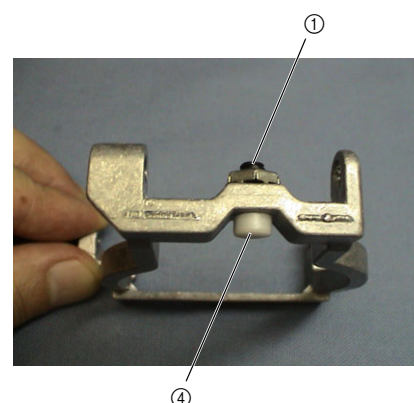
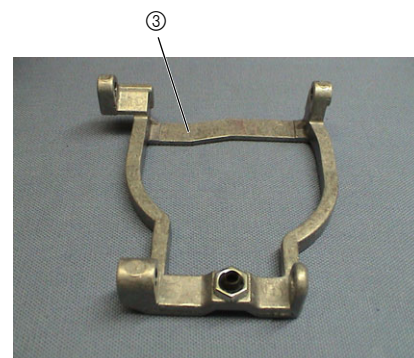
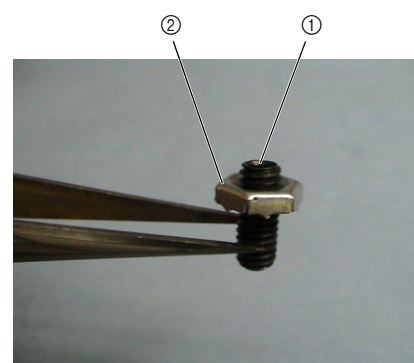

## 24 Feed dog correction plate attachment

1. Attach the feed dog correction plate ① to the feed dog base assembly ② with the screw ❶.

**\*Key point**

- Move the feed dog correction plate ① upward to attach it.

❶		Screw M3X8	Torque Hand tighten
---	---	---------------	------------------------

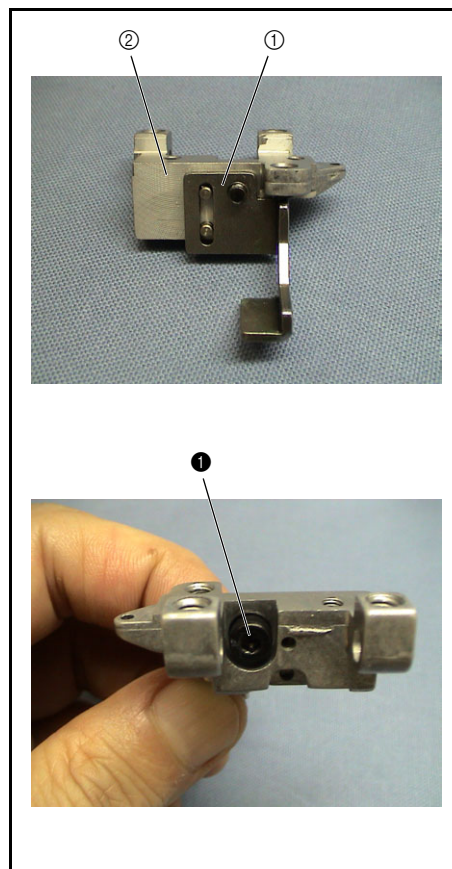



## 25 Feed dog base assembly attachment

1. Apply a small bead of MOLYKOTE EM-30L to the shaft holes at the right and left ends of the feed bar ①.
2. Attach the polyester slider ③ to the inside of the feed bar ① on the left side, and then place the feed dog base assembly ② in the feed bar ①.
3. Insert the feed bar shaft A ④ from the left side of the feed bar ①, and then pass the shaft through the shaft hole on the feed bar and the shaft hole on the feed dog base assembly ②.
4. Insert the feed bar shaft B ⑤ from the right side of the feed bar ①, and then pass the shaft through the shaft hole on the feed bar and the shaft hole on the feed dog base assembly ②.
5. Secure the feed bar shaft A ④ on the left side with the screw ❶.

**\*Key point**

- Move the feed dog base assembly ② to the left, and then tighten the screw ❶.

6. Secure the feed bar shaft B ⑤ on the right side with the screw ❶.



**\*Key point**

- Tighten the screw ❶ so that the right end of the feed bar shaft B ⑤ is level with the right end of the feed bar ①.

Apply MOLYKOTE EM-30L to the shaft holes at the right and left ends of the feed bar.
--

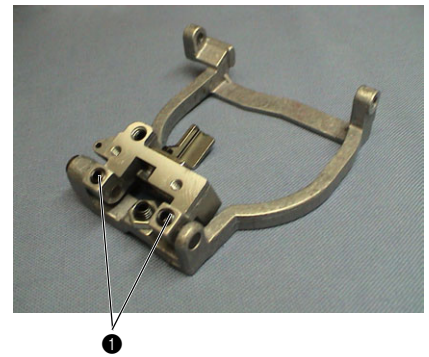
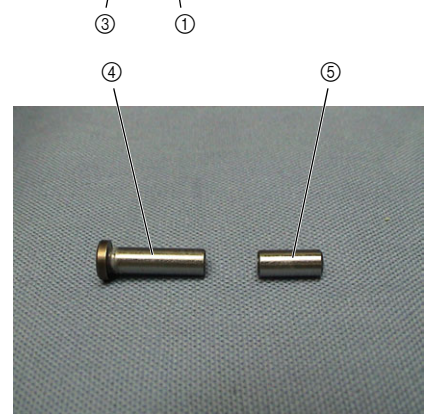
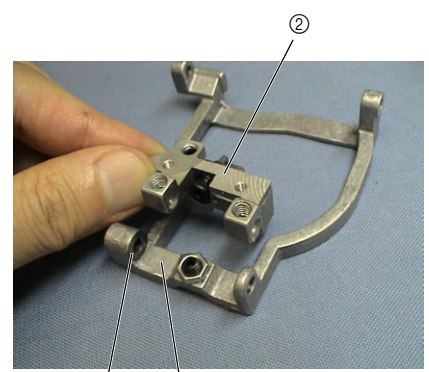
Small bead XC8385***
-------------------------



❶	 	Set Screw, Socket (CP) M4X4	Torque 1.18 – 1.57 N·m
---	---	--------------------------------	---------------------------

## 26 Feed bar assembly attachment

1. Apply a small bead of MOLYKOTE EM-30L to the hole on the feed shaft ② of the feed bar ①.
2. Place the feed bar ③ in the base plate assembly.
3. Apply a small bead of MOLYKOTE EM-30L to feed bar shaft A.
4. Pass the feed bar shaft A ④ (both right and left) through the hole on the feed shaft ② and the hole on the feed arm ⑤, and then secure it with the screw ①.

**\*Key point**

- Align the end face of feed bar shaft A with the end face of the feed arm (both right and left).

Apply MOLYKOTE EM-30L to the hole on the feed shaft of the feed bar.	Small bead XC8385***
Apply MOLYKOTE EM-30L to feed bar shaft A.	Small bead XC8385***

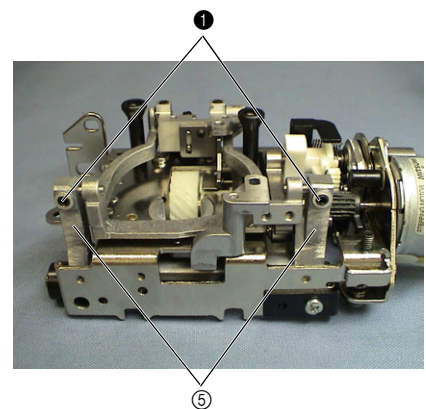
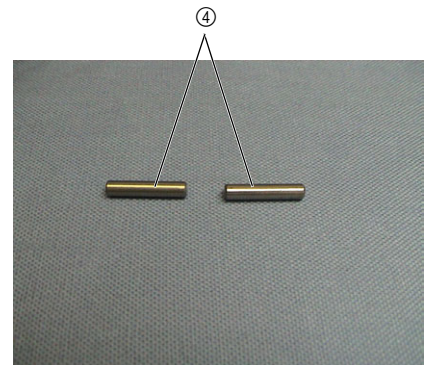
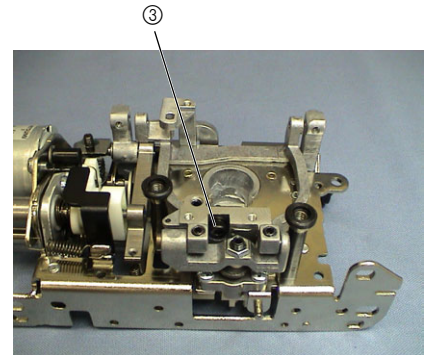
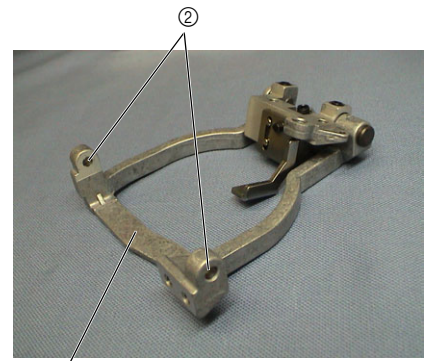

①		Set Screw, Socket (CP) M4X4	Torque 1.18 – 1.57 N·m
---	--	--------------------------------	---------------------------

**27** Spring attachment

1. Attach the spring **S63** to the feed bar ① and the vertical feed shaft ②.

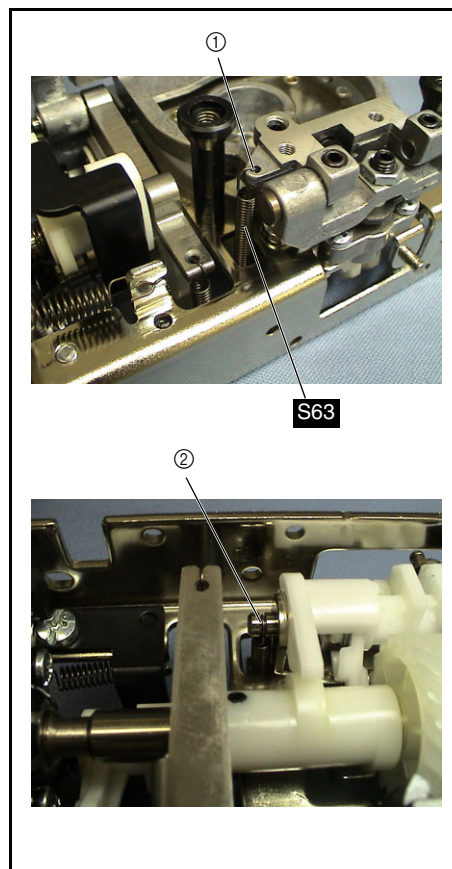

S63

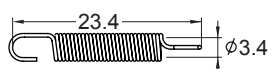
SPRING  
XZ0385\*\*\*

### 28 Outer rotary hook attachment

1. Apply a bead of MOLYKOTE EM-30L to the outer rotary hook attachment face of the shaft supporter ①.
2. Apply a small bead of EPNOC AP (N)0 to the groove on the outer rotary hook shaft ②.
3. Attach the spacer ④ to the outer rotary hook assembly ③, and then insert the outer rotary hook shaft ②.
4. Place washer 6 ⑤ and the spacer ④ onto the outer rotary hook shaft ② from the bottom.

**NOTE**

- The shape of the spacer ④ and the washer 6 ⑤ is the same. Be careful not to confuse them. The washer 6 ⑤ is thicker.
5. Rotate the outer rotary hook assembly ③ clockwise with the D-cut face of the lower shaft B ⑥ facing the top (the slit on the joint is horizontal) to insert the outer rotary hook assembly ③ into the shaft supporter ①.

**\*Key point**

- Hold the lower shaft B ⑥ with the D-cut face facing the top while inserting the outer rotary hook assembly ③.
  - Turn the outer rotary hook assembly ③ counterclockwise 45 degrees and insert it so that the reference hole ⑦ on the outer rotary hook faces the front.
6. Secure the outer rotary hook assembly with the screw ①.

Apply MOLYKOTE EM-30L to the outer rotary hook attachment face of the shaft supporter.	Bead
Apply EPNOC AP (N)0 to the groove on the outer rotary hook shaft.	Small bead XC8387***

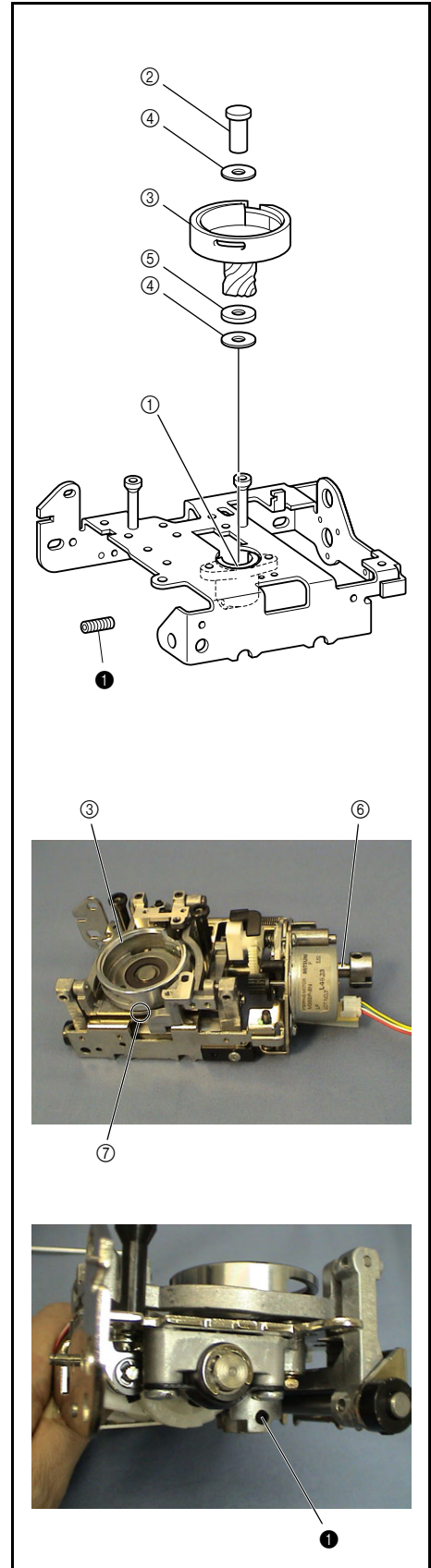

Assembly

①		Set Screw, Socket (CP) M4X6	Torque 0.78 – 1.18 N·m
---	--	--------------------------------	---------------------------

### 29 Feed dog attachment

1. Attach the feed dog ① to the feed dog base with the 2 screws ❶.

❶		Screw, Bind M3X6	Torque 0.78 – 1.18 N·m
---	---	---------------------	---------------------------

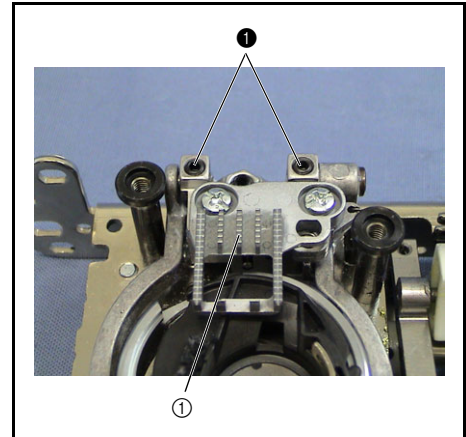

### 30 Needle plate A assembly

1. Attach the stopper plate ① to the rear of the needle plate A ② with the screw ❶.

**\*Key point**

- Engage the positioning tab on the stopper plate ① with the positioning hole on the needle plate A ②.

2. Attach the stopper plate ③ and then the needle plate supporting plate ④ to the rear of the needle plate A ② with the 2 screws ❶.

**\*Key point**

- Engage the positioning tab on the stopper plate ① with the positioning hole on the needle plate A ②.

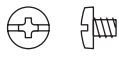
❶		Screw, Bind M2.6X3	Torque 0.59 – 0.78 N·m
---	---	-----------------------	---------------------------

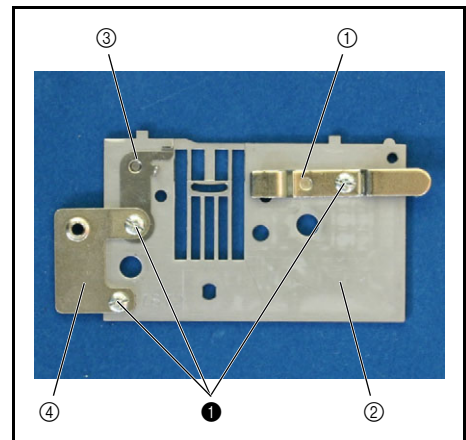

### 31 Needle plate A attachment

1. Attach needle plate A ① to the needle plate supporter shaft with the 2 screws ❶.

**\*Key point**

- Refer to "Feed dog height and squareness adjustment" on page 4 - 20 for the adjustment procedure.

❶		Screw M4	Torque 1.18 – 1.57 N·m
---	---	-------------	---------------------------

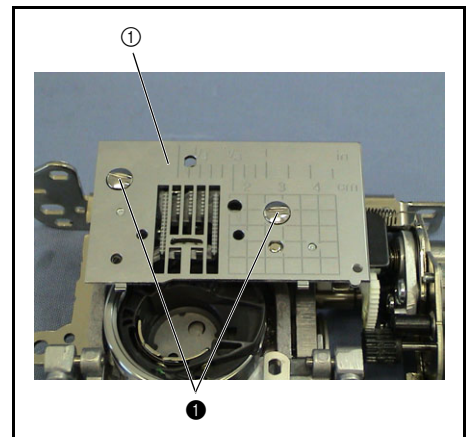



### 32 Photo diode holder ASSY assembly

- Engage the photo diode holder assembly ① with the 2 hooks on the photo diode holder ②.

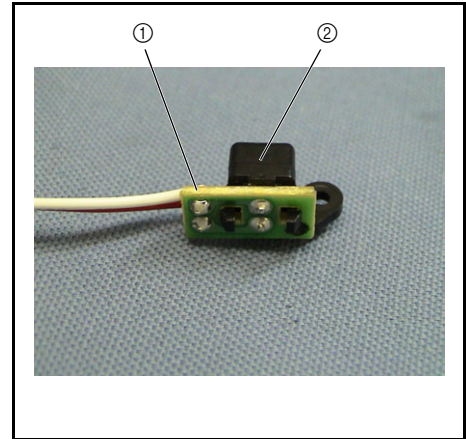



### 33 Photo diode holder assembly attachment

- Attach the photo diode holder assembly ① to the inner rotary hook bracket ② with the screw ③.

**\*Key point**

- Engage the positioning tab on the photo diode holder assembly ① with the positioning hole on the inner rotary hook bracket ②.

①	 	Screw, Bind M2X4	Torque 0.29 – 0.49 N·m
---	---	---------------------	---------------------------

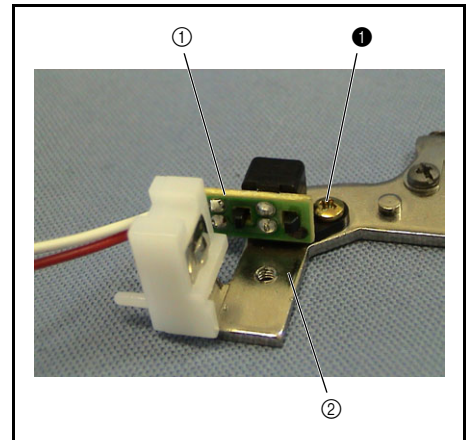

### 34 Needle plate switch ASSY attachment

- Insert the PLT SW D6 assembly ① into the needle plate switch holder ②.

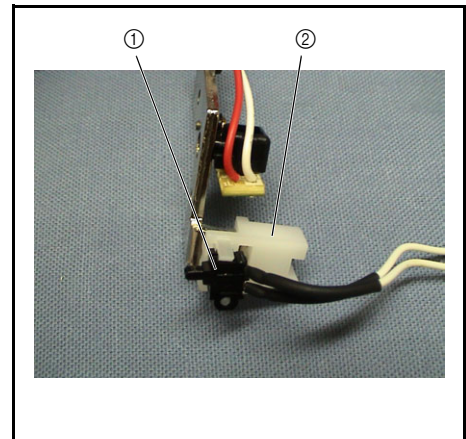

**\*Key point**

- Align the pin of the needle plate switch holder ② with the hole on the PLT SW D6 assembly ①, and then insert the assembly until it catches the hook on the needle plate switch holder ②.



### 35 Cord holder attachment

- Store the SW lead wire ① and the photo diode lead wire ② in the cord holder ③.
- Attach the cord holder ③ to the inner rotary hook bracket ④ with the screw ①.

①	 	Screw, Bind M2.6X3	Torque 0.29 – 0.49 N·m
---	---	-----------------------	---------------------------

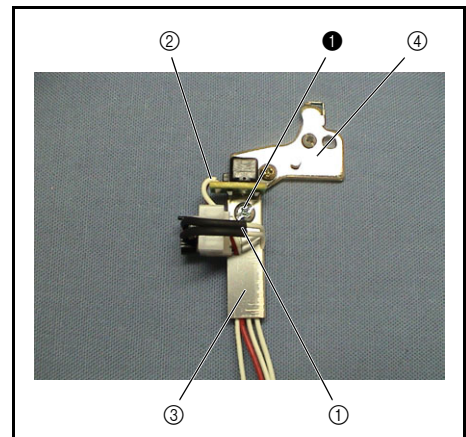



### 36 Inner rotary hook bracket assembly

1. Attach the inner rotary hook bracket ① to the stopper plate block ② with the screw ③.

**\*Key point**

- Engage the positioning tab on the inner rotary hook bracket ① with the positioning slot on the stopper plate block ②.
- Refer to "Inner rotary hook bracket position adjustment" on page 4 - 18 for the adjustment procedure.

③		Screw, Bind M3X8	Torque 0.78 – 1.18 N·m
---	---	---------------------	---------------------------

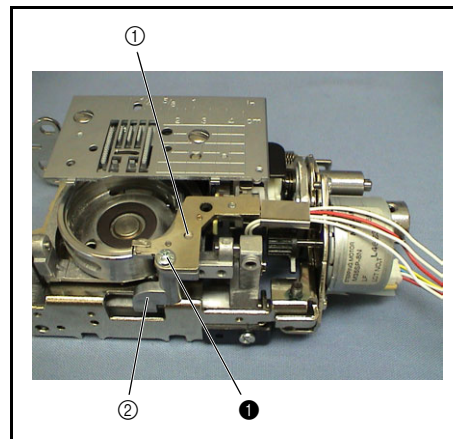

### 37 Drop lever attachment

1. Insert the base plate ② into the groove below the drop lever ①.
2. Position the drop lever ① and the vertical lever ③ as shown in the illustration on the right.
3. Attach a retaining ring (E2) to one end of the 2 slide shafts A ④.
4. Insert 2 slide shafts A ④ from the outside of the base plate, and attach the retaining ring (E2) from the inside of the base plate.
5. Apply a small bead of MOLYKOTE EM-30L to the 2 oscillating sections ⑤ of the drop lever and slide shaft A.

Apply MOLYKOTE EM-30L to the 2 oscillating sections of the drop lever and slide shaft A.
--

Small bead
------------

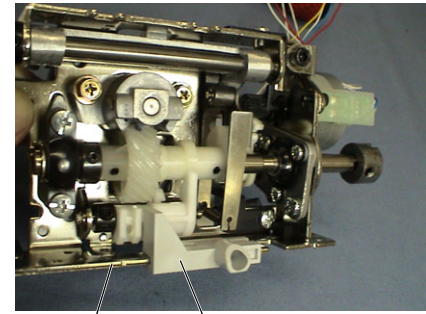

② ①

Retaining ring E2

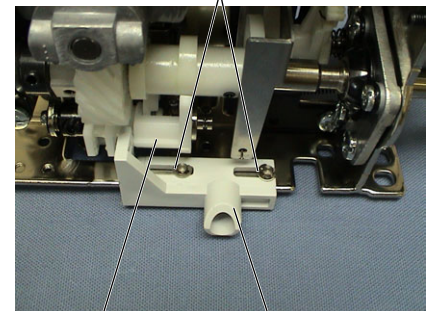

③ ①

Retaining ring E2

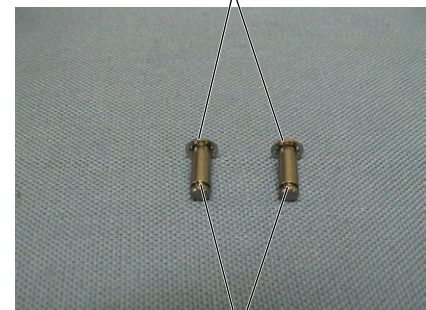

④

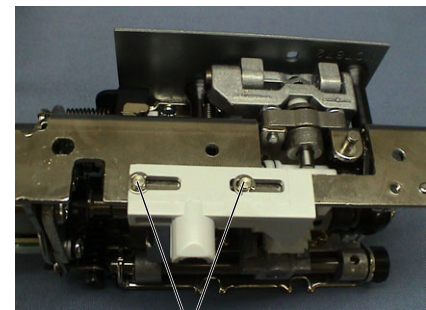

⑤

**38** Drop knob attachment

1. Place the drop knob ① onto the pin of the drop assembly, and then attach the retaining ring (E3).
2. Attach the plate spring ② with the screw ①.

**\*Key point**

- Hang the lower hook of the plate spring ② over the base plate.
- Move the drop knob ① vertically to check that it operates (a click can be heard).

①		<p>Screw, Bind M3x4</p> <p>Torque 0.78 – 1.18 N·m</p>
---	---	---

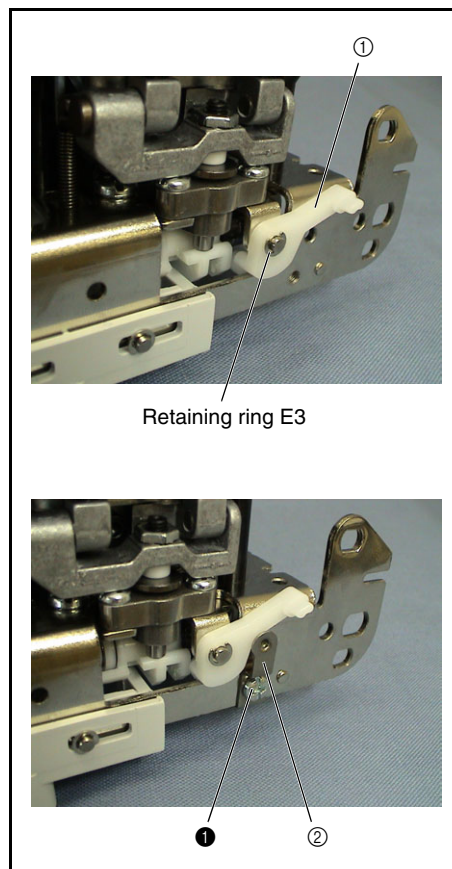

### Needle-presser module location diagram

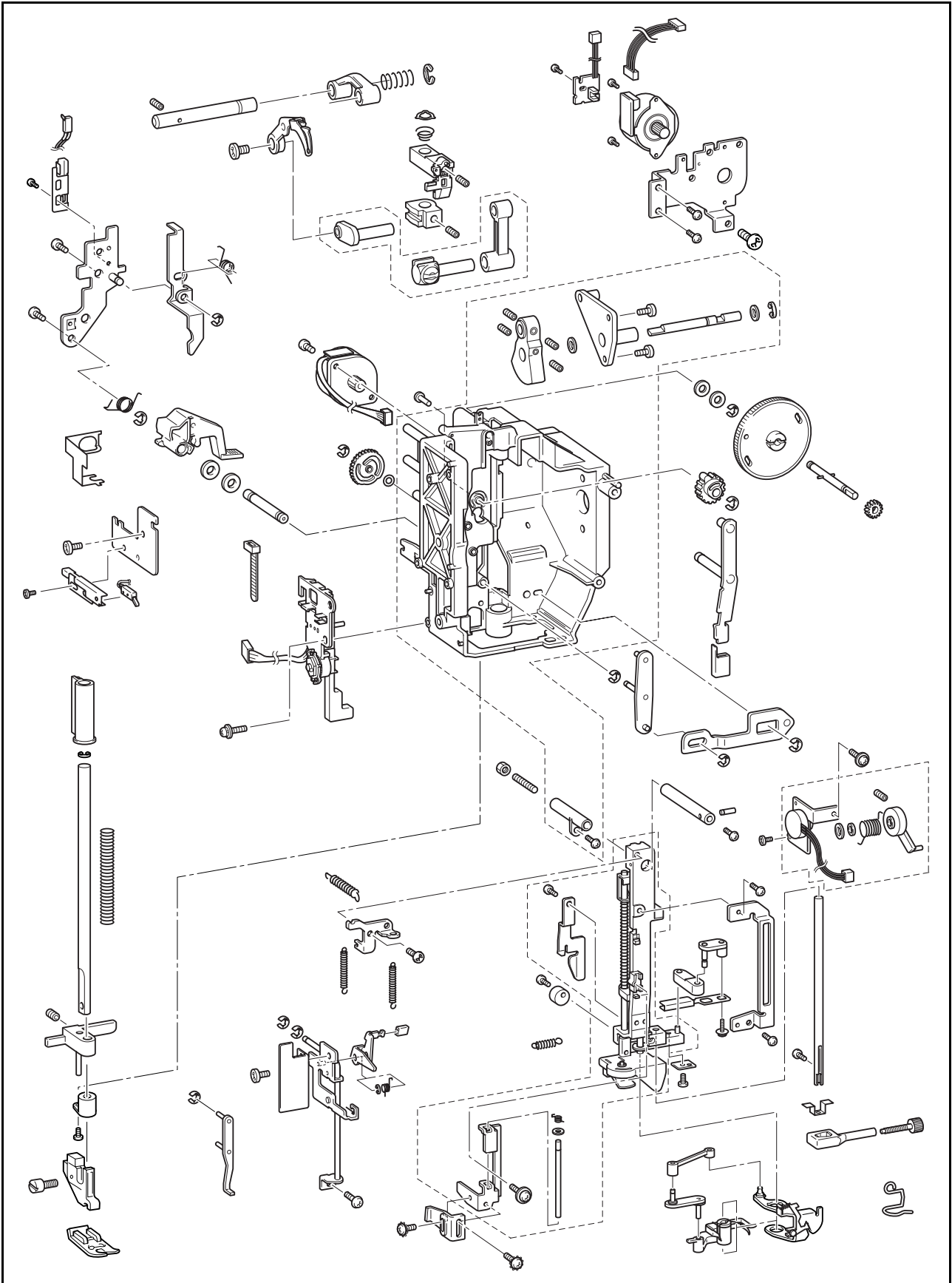

## 1 Presser dial gear attachment

1. Apply a light covering of MOLYKOTE EM30L to the oscillating sections of the presser foot rack ① gear and the unit holder ②.
2. Insert the presser foot rack ① into the unit holder ②.
3. Insert the presser dial gear ③ into the unit holder ②.

### \*Key point

- Align the mark (trough) ④ on the presser foot rack ① with the mark (ridge) ⑤ on the presser dial gear ③.

4. Insert the presser dial shaft assembly ⑥ into the presser dial gear ③ through the shaft hole on the unit holder ②.

### \*Key point

- Align the D-cut face of the presser dial shaft assembly ⑥ with the D-cut face of the presser dial gear ③.
- Insert the presser dial shaft assembly ⑥ until the hook of the presser dial gear ③ is caught in the groove on the presser dial shaft assembly ⑥.

Apply MOLYKOTE EM30L to the oscillating sections of the presser foot rack gear and the unit holder.
---

Light covering XC8385***
-----------------------------

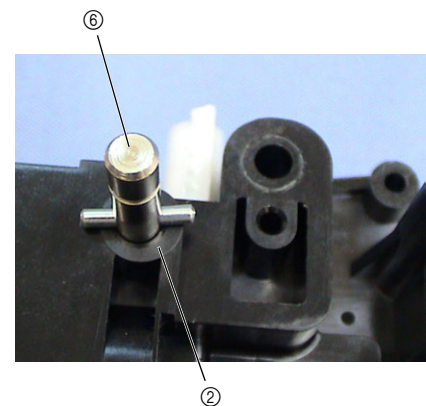
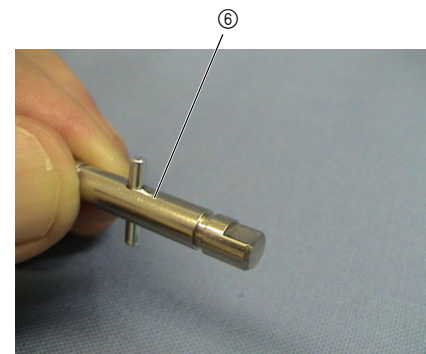
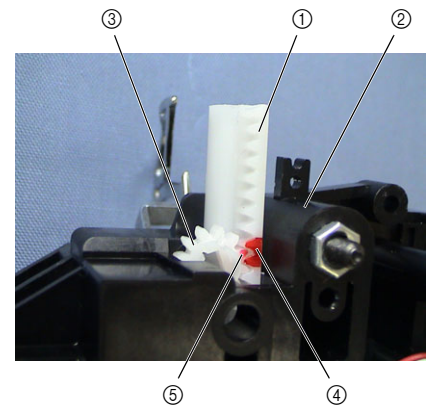
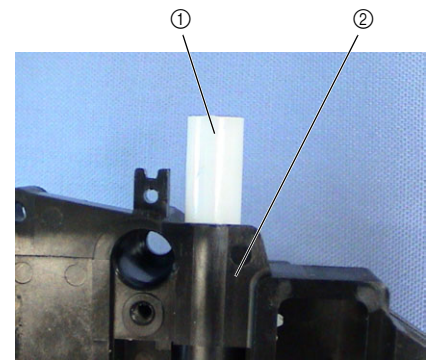

## 2 Shaft bushing attachment

1. Attach the shaft bushing ① to the unit holder with the 2 screws ①.

**\*Key point**

- Insert the shaft bushing from the inside of the unit holder.

①		Screw, Pan (SIP washer) M4X14	Torque 1.18 – 1.57 N·m
---	--	----------------------------------	---------------------------

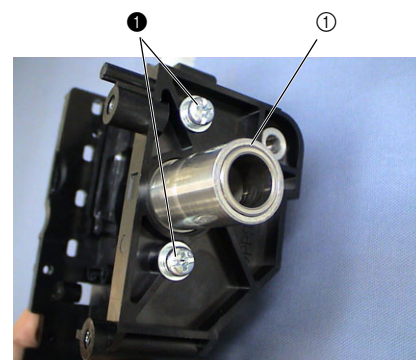
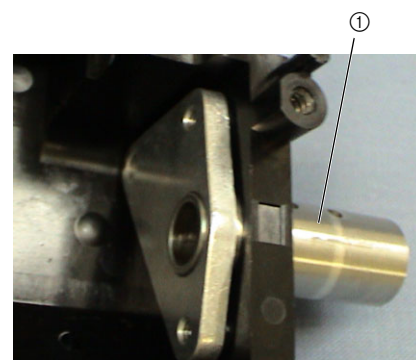



### 3 Thread take-up lever link attachment

1. Insert the shaft ① into the shaft hole on the shaft bushing ②.

**\*Key point**

- Insert the shaft ① from the end without a groove for a retaining ring.

2. Apply a light covering of MOLYKOTE EM30L to the circumference of the shaft hole on the thread take-up lever link ③.
3. Insert the spring S06 and the thread take-up lever link ③ into the shaft ①.

**\*Key point**

- Insert the end of the thread take-up lever link ③ with the larger cylindrical section.



4. Attach the retaining ring (E4) to the shaft ①.

**\*Key point**

- Move the spring S06 to the thread take-up lever link ③.
- Do not allow any clearance between the retaining ring (E4) and the shaft bushing ②.

5. Tighten the screw ❶ in the shaft ①, and then apply 1 or 2 drops of THREEBOND 1401 to the screw ❶ to secure it.

Apply MOLYKOTE EM30L to the circumference of the shaft hole on the thread take-up lever link.	Light covering XC8385***
Apply THREEBOND 1401 to the screw ❶ in the shaft.	1 - 2 drops

❶		Set Screw, Socket (CP) M3X5	Torque 0.49 N·m
S06			SPRING XC2441***

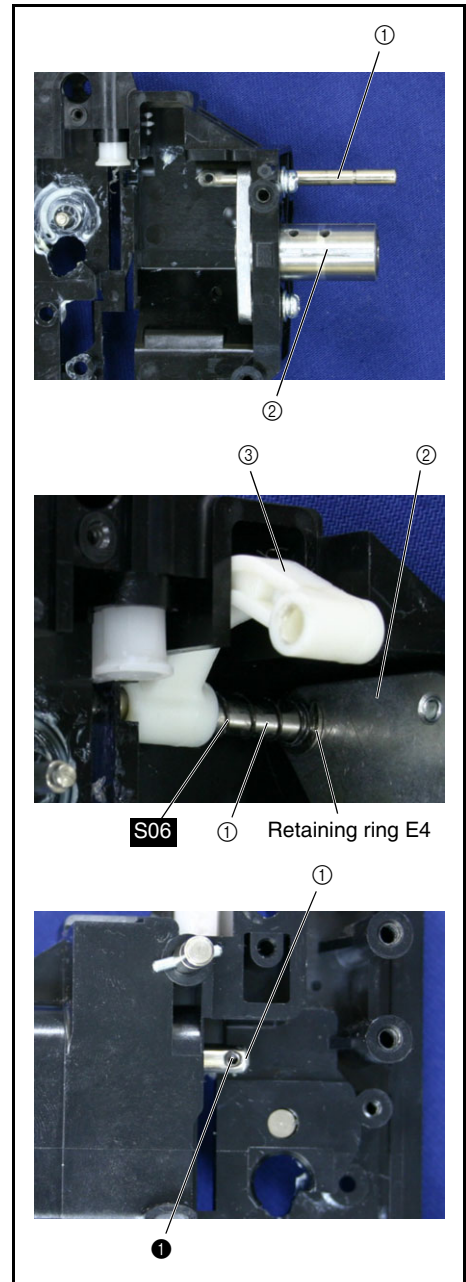

### 4 Presser bar attachment

1. Insert the presser bar bushing ① into the shaft hole on the bottom of the unit holder.
2. Attach the plate spring ② to the unit holder with the screw ①.

**\*Key point**

- Press the presser bar bushing ① with the plate spring ②.

3. Attach the retaining ring (E5) to the groove on the presser bar ③.
4. Dip the tip of the presser bar ③ (opposite end from the retaining ring) in FBK OIL RO 100.
5. Insert the presser bar ③ into the presser foot rack ④.
6. Temporarily attach the screw ② to the presser bar clamp ⑤.
7. Adjust the presser bar ③ height and parallel alignment, and then fully tighten the screw ②.

**\*Key point**

- Refer to "Presser bar height and parallelism adjustment" on page 4 - 12 for the adjustment procedure.



8. Apply a bead of MOLYKOTE EM30L to the groove on the stopper pin of the unit holder.
9. Insert the spring S60 and the presser bar clamp ⑤ into the presser bar ③.

**\*Key point**

- Engage the stopper pin ⑥ of the presser bar clamp ⑤ with the groove on the stopper pin of the unit holder.

10. Pass the presser bar ③ through to the presser bar bushing ①.

Dip the tip of the presser bar (opposite end from the retaining ring) in FBK OIL RO 100.	Dipping XC8388***
Apply MOLYKOTE EM30L to the groove on the stopper pin of the unit holder.	Bead XC8385***

①		Tapite, Bind B M3X8	Torque 0.58 - 0.78 N·m
②		Set Screw, Socket (CP) M5X10	Torque 0.58 - 0.78 N·m
S60			SPRING XC7810***

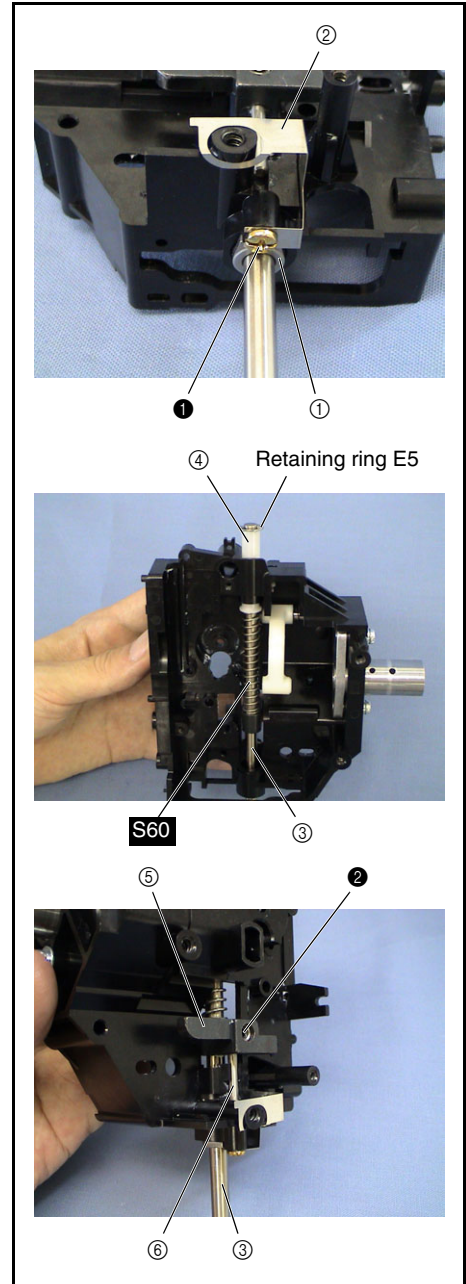

## 5 T cam attachment

1. Place the polyester slider ① onto the T cam attachment shaft ② of the unit holder.
2. Apply a small bead of MOLYKOTE EM30L to the T cam attachment shaft ②.
3. Apply a light covering of MOLYKOTE EM30L to the cam groove on the T cam ③.
4. Apply a light covering of MOLYKOTE EM30L to the gear of the T cam ③.
5. Place the T cam ③ onto the T cam attachment shaft ②.

### \*Key point

- Position the T cam ③ with the cam groove down.
- Press the cut face of the T cam ③ against the wall of the unit holder ④ to insert the T cam ③.

Apply MOLYKOTE EM30L to the T cam attachment shaft.	Small bead XC8385***
Apply MOLYKOTE EM30L to the cam groove on the T cam.	Light covering XC8385***
Apply MOLYKOTE EM30L to the gear of the T cam.	Light covering XC8385***

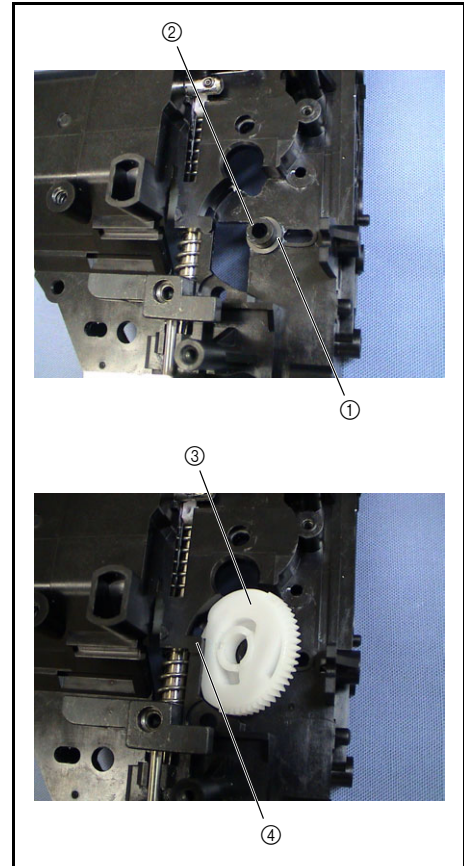

## 6 Shaft attachment

1. Insert the shaft ① from the rear of the unit holder.

### \*Key point

- Fully insert the shaft.

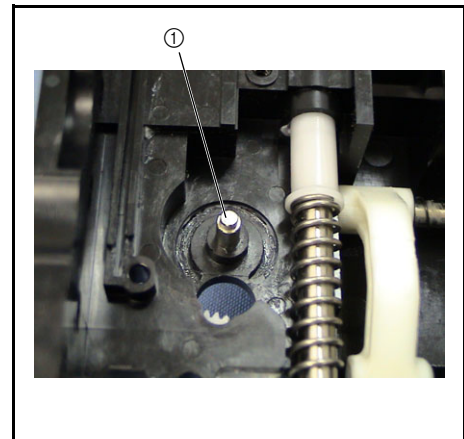

### 7 Z pulse motor assembly attachment

1. Apply 1 or 2 drops of FBK OIL RO 100 to the shaft of the Z pulse motor assembly ①.
2. Attach the insulation tape to the PCB of the Z pulse motor assembly ①.
3. Attach the Z pulse motor assembly ① to the unit holder with the screw ①.

**\*Key point**

- Align the mark (ridge) on the Z pulse motor assembly ① with the mark (trough) on the T cam ②.
- Rotate the Z pulse motor assembly ① clockwise to attach it.

Apply FBK OIL RO 100 to the shaft of the Z pulse motor assembly.	1 - 2 drops XC8388***
--	--------------------------

① 	Taptite, Bind B M3X10	Torque 0.78 – 1.18 N·m
---	--------------------------	---------------------------

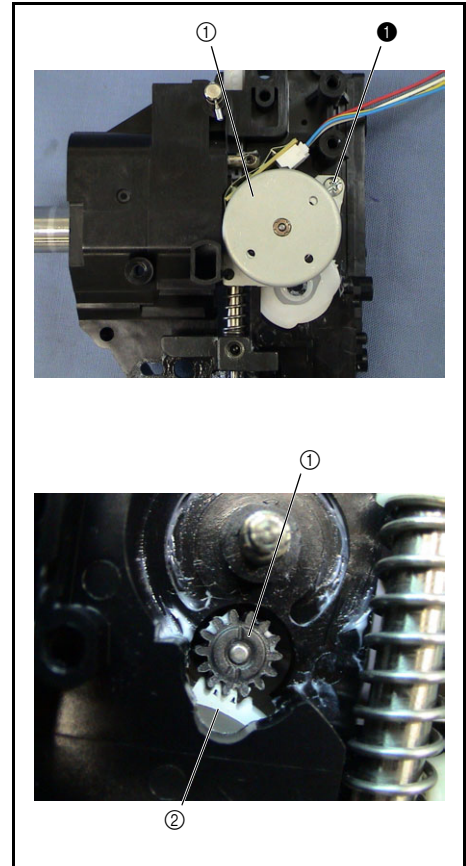

### 8 Z zigzag cam attachment

1. Apply a small bead of MOLYKOTE EM30L to the Z zigzag cam shaft ①.
2. Attach the Z zigzag cam ② to the Z zigzag cam shaft ①.

**\*Key point**

- Align the mark ③ (ridge) on the Z zigzag cam ② with the mark ④ (trough) on the Z pulse motor assembly.
3. Attach the retaining ring (E2) to the Z zigzag cam shaft ①.
  4. Apply a small bead of MOLYKOTE EM30L to the gear circumference of the Z zigzag cam ②.

Apply MOLYKOTE EM30L to the Z zigzag cam shaft.	Small bead XC8385***
Apply MOLYKOTE EM30L to the gear circumference of the Z zigzag cam.	Small bead XC8385***

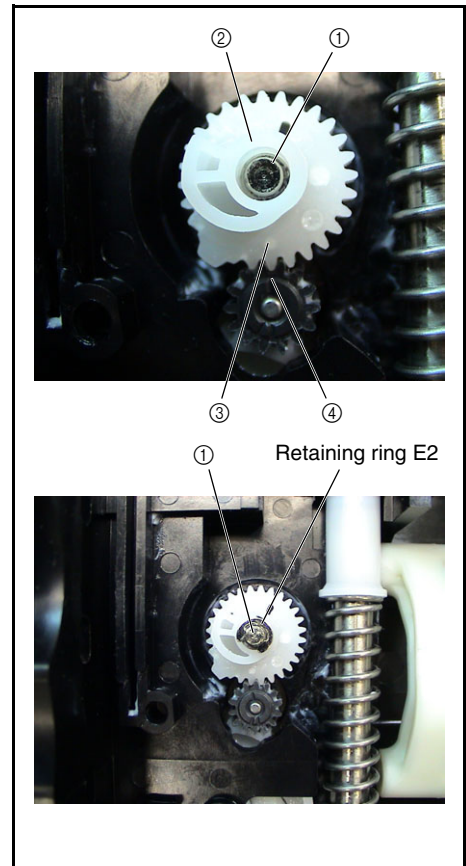



## 9 Thread release lever assembly attachment

1. Apply a small bead of MOLYKOTE EM30L to the calking shaft (center) ② of the thread release lever ①.
2. Insert the calking shaft (center) ② of the thread release lever ① into the shaft hole on the unit holder, and then attach the retaining ring (E3).

### \*Key point

- Check that the caulking shaft (upper) ④ is inserted into the groove on the T cam ③.
3. Apply a bead of MOLYKOTE EM30L to the calking shaft (lower) ③ of the thread release lever ①.

Apply MOLYKOTE EM30L to the calking shaft (center) of the thread release lever.	Small bead XC8385***
Apply MOLYKOTE EM30L to the calking shaft (lower) of the thread release lever.	Bead XC8385***

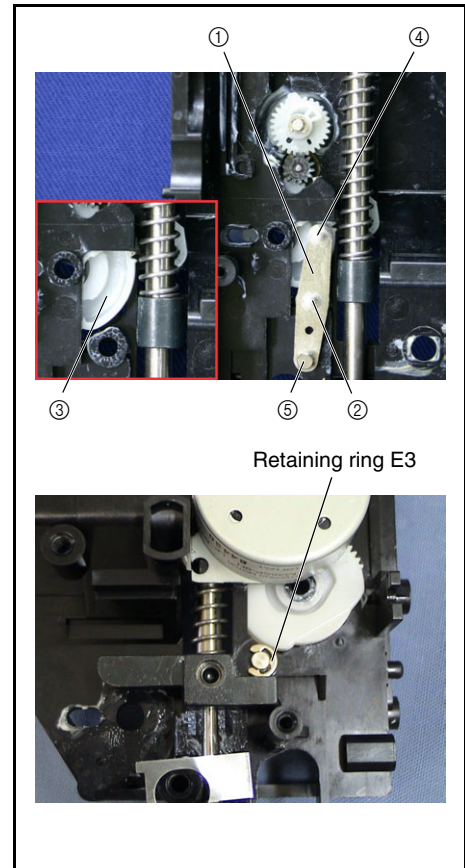

## 10 Z zigzag lever assembly attachment

1. Attach the cap ① to the tip of the Z zigzag lever assembly ② as shown in the illustration on the right.
2. Apply a small bead of MOLYKOTE EM30L to the calking shaft (center) of the Z zigzag lever assembly ②.
3. Insert the calking shaft (center) of the Z zigzag lever assembly ② into the shaft hole on the unit holder, and then attach the retaining ring (E3) from the rear of the unit holder.

### \*Key point

- Check that the boss ③ on the Z zigzag lever assembly ② is on the left side of the Z zigzag cam ④.
- Attach the retaining ring (E3) to the T cam ⑤.

Apply MOLYKOTE EM30L to the calking shaft (center) of the Z zigzag lever assembly.
--

Small bead XC8385***
-------------------------

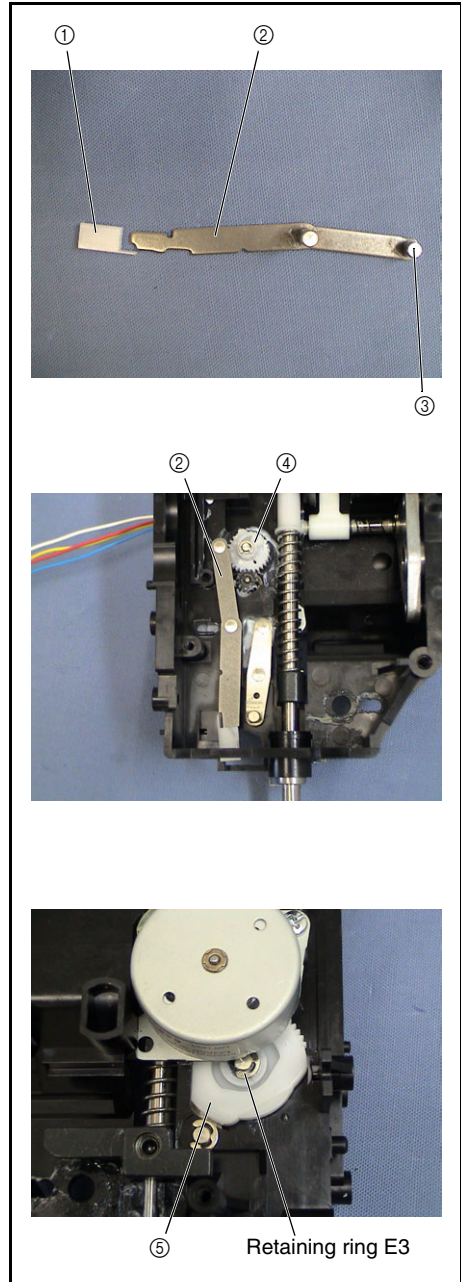



### 11 Thread take-up counter weight attachment

1. Temporarily attach the 4 screws ❶ to the thread take-up counter weight ❶.
2. Attach the retaining ring (E8) to the groove on the unit shaft ❷, and then insert the thrust washer ❸ from the D-cut face of the unit shaft ❷.
3. Apply 1 or 2 drops of FBK OIL RO 100 to the unit shaft ❷ and the shaft hole on the shaft bushing ❹.
4. Insert the D-cut face of the unit shaft ❷ into the shaft hole on the shaft bushing ❹.
5. Insert the thrust washer ❸ and the thread take-up counter weight ❶ from the D-cut face of the unit shaft ❷.
6. Fully tighten the 2 screws ❶ of the thread take-up counter weight ❶ with the D-cut face next to the unit shaft ❷ retaining ring (E8) and the screw hole face ❺ of the thread take-up counter weight ❶ facing the front. (See the illustration on the right.)

**\*Key point**

- Tighten the 2 face-to-face screws ❶ temporarily attached to the center of the thread take-up counter weight ❶.

Apply FBK OIL RO 100 to the unit shaft.	1 - 2 drops XC8388***
Apply FBK OIL RO 100 to the shaft hole on the shaft bushing.	1 - 2 drops XC8388***

❶		Set Screw, Socket (FT) M5X5	Torque 1.37 – 1.77 N·m
---	---	--------------------------------	---------------------------

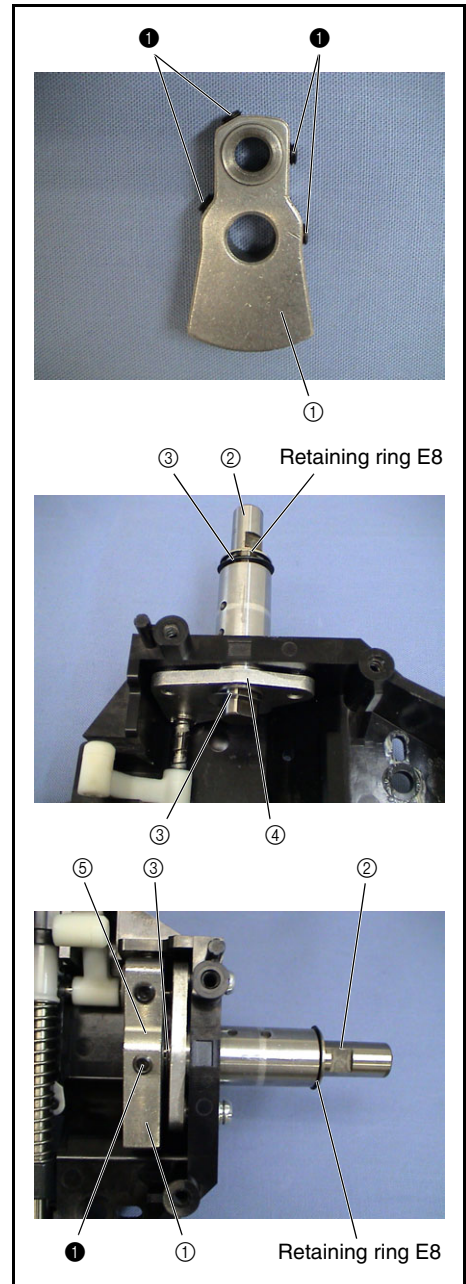

## 12 Thread take-up lever assembly attachment

1. Apply a bead of MOLYKOTE EM30L to the 2 calking shafts of the needle bar crank ①.
2. Apply a bead of MOLYKOTE EM30L to the calking shaft of the thread take-up lever assembly ②.
3. Insert the needle bar crank ③ rod (end with the larger diameter) into the calking shaft (longer) of the needle bar crank ①.
4. Apply a bead of MOLYKOTE EM30L to the screw attachment face of the needle bar crank ① (tip of the shorter calking shaft).
5. Insert the calking shaft (longer) of the needle bar crank ③ into the thread take-up counter weight ④.

**\*Key point**

- Align the D-cut face of the needle bar crank ③ calking shaft with the screw hole on the thread take-up counter weight ④.

6. Fully tighten the 2 screws ① temporarily attached to the thread take-up counter weight ④.
7. Insert the calking shaft of the thread take-up lever assembly ② into the shaft hole on the thread take-up lever link ⑤.
8. Insert the calking shaft (shorter) of the needle bar crank ① into the shaft hole on the thread take-up lever assembly ②, and then tighten the screw ②.

**\*Key point**

- The screw ② has a reverse helical flute thread.

Apply MOLYKOTE EM30L to the 2 calking shafts of the needle bar crank.	Bead XC8385***
Apply MOLYKOTE EM30L to the calking shaft of the thread take-up lever assembly.	Bead XC8385***
Apply MOLYKOTE EM30L to the screw attachment face of the needle bar crank (tip of the shorter calking shaft).	Bead XC8385***

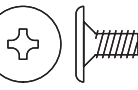
①		Set Screw, Socket (FT) M5X5	Torque 1.37 – 1.77 N·m
②		Screw, Flat SM3.57	Torque 1.18 – 1.57 N·m

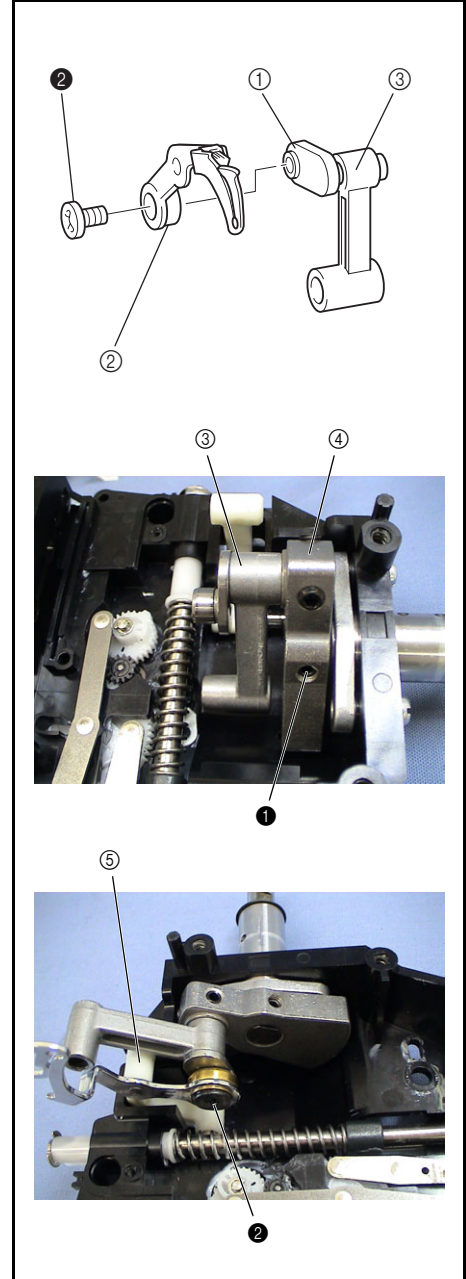

### 13 Tension release rod attachment

1. Apply a small bead of MOLYKOTE EM30L to the calking shaft of the tension release rod ①.
2. Insert the calking shaft of the thread release lever assembly ③ into the slot on the tension release rod ②, and then insert the calking shaft of the tension release rod ① into the shaft hole on the unit holder.
3. Attach the retaining ring (E3) to the calking shaft of the thread release lever assembly ③.

Apply MOLYKOTE EM30L to the calking shaft of the tension release rod.
---

Small bead XC8385***
-------------------------

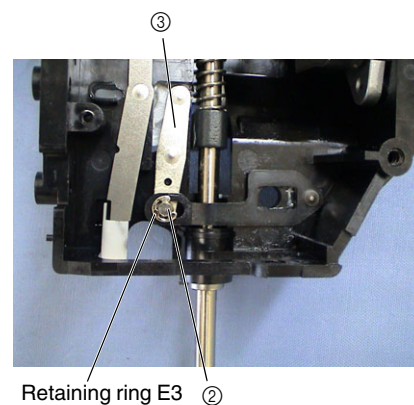
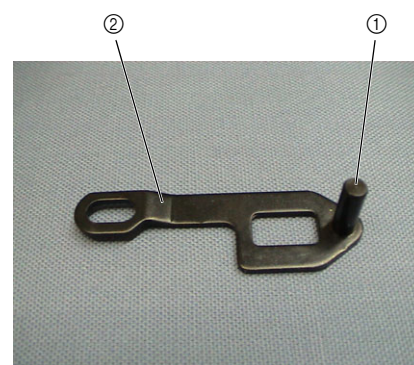

## 14 Press foot lifter attachment

1. Attach the retaining ring (E4) to the groove near the edge of the presser lift shaft ①.
2. Apply a light covering of MOLYKOTE EM30L to the surface of the presser lift shaft ①.
3. Insert the presser lift shaft ① from the thread release rod.
4. Insert the 2 washers ② into the presser lift shaft ① from the rear of the unit holder.

### \*Key point

- Lift the presser bar clamp slightly when inserting washers ②.
5. Apply a bead of MOLYKOTE EM30L to the section where the presser foot lever ③ contacts the presser bar clamp.
  6. Insert the presser foot lever ③ into the presser lift shaft ① from the rear of the unit holder, and then attach the retaining ring (E4).

Apply MOLYKOTE EM30L to the surface of the presser lift shaft.	Light covering XC8385***
Apply MOLYKOTE EM30L to the section where the presser foot lever contacts the presser bar clamp.	Bead XC8385***

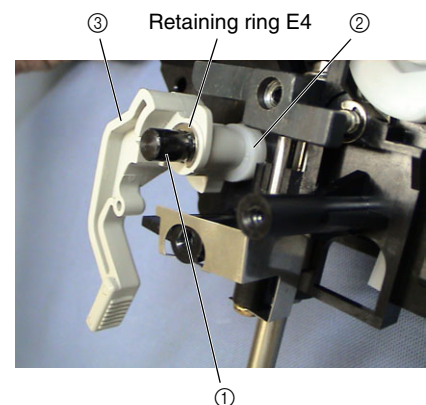
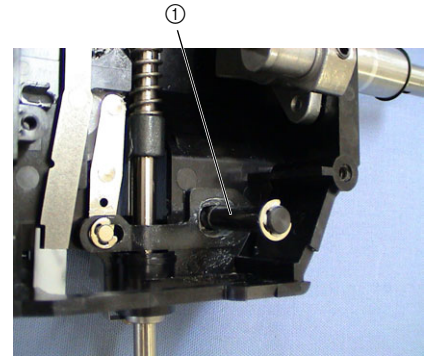
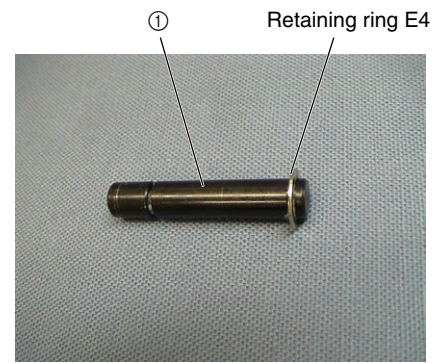

## 15 Release plate assembly attachment

1. Apply a small bead of MOLYKOTE EM30L to the calking shaft at the end of the release plate assembly ①.
2. Insert the release plate assembly ① into the shaft hole on the unit holder.

**\*Key point**

- Move the Z zigzag cam ② to the position of the photo.
3. Attach the retaining ring (E2) to the calking shaft of the release plate assembly ① from the rear of the unit holder.

Apply MOLYKOTE EM30L to the calking shaft at the end of the release plate assembly.
---

Small bead XC8385***
-------------------------

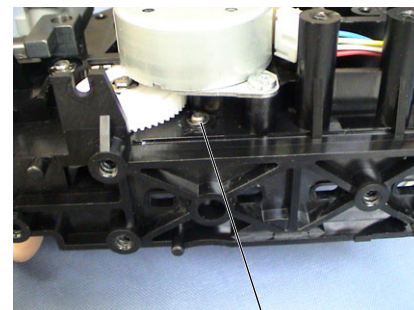
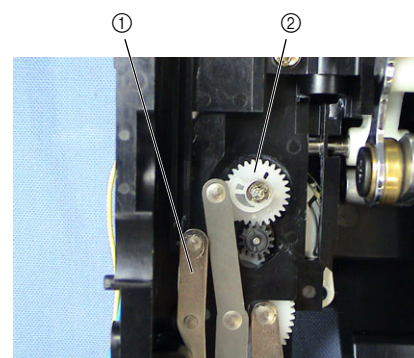
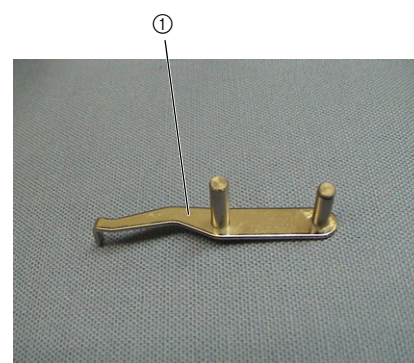

Retaining ring E2



### 16 Adjusting plate ASSY assembly

1. Apply a small bead of EPNOC AP (N)0 to the calking shaft of the adjusting plate ①.
2. Place the switch lever ② and the spring **S68** onto the calking shaft of the adjust plate ①, and then attach the retaining ring (E3).

Apply EPNOC AP (N)0 to the calking shaft of the adjusting plate.

Small bead  
XC8387\*\*\*

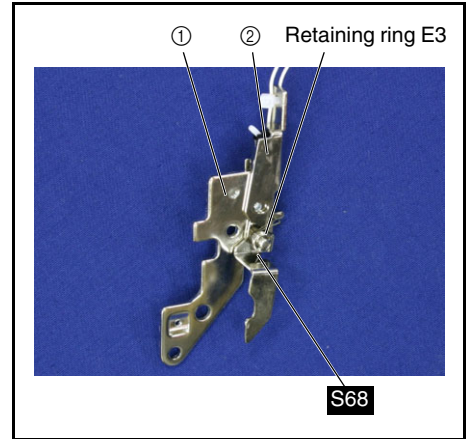
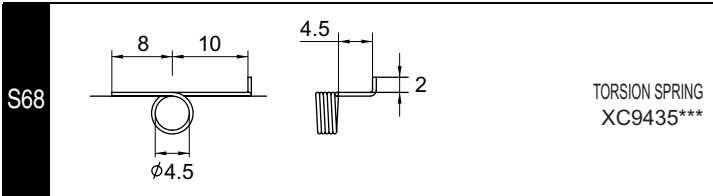

### 17 PF switch D6M assembly attachment and adjustment

1. Attach the PF switch assembly ② to the adjusting plate assembly ① with the screw ①.

**\*Key point**

- Insert a 1.0 mm thickness gauge into the section between the PF switch assembly ② and the switch lever.

	<p>Screw, Bind M3X4</p>	<p>Torque 0.78 - 1.18 N·m</p>
--	-----------------------------	-----------------------------------

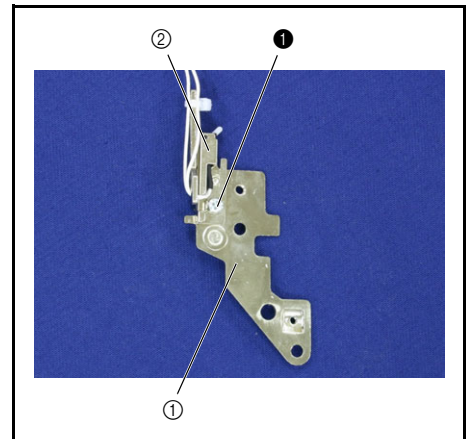



### 18 Adjusting plate assembly attachment

1. Place the spring **S58** onto the presser lift shaft ①.
2. Attach the L-shaped section of the spring **S58** to the groove on the presser foot lifter ②.
3. Attach the adjusting plate assembly ③ to the unit holder with the 2 screws ④.

**\*Key point**

- Attach the hook ④ of the spring **S58** to the adjusting plate assembly ②.
- Press the indicated section ⑤ of the adjusting plate assembly to the indicated section ⑥ of the unit holder to prevent any clearance.

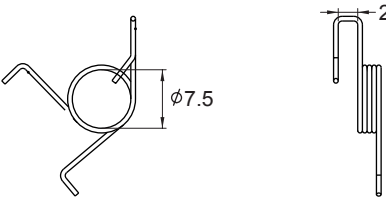
①		Taptite, Bind B M4X10	Torque 1.18 - 1.57 N·m
S58		SPRING XC7813***	

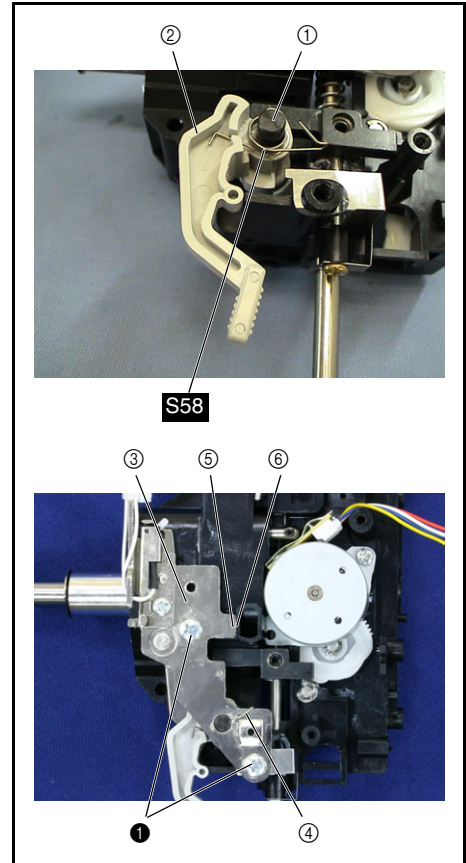

### 19 Adjust plate attachment

1. Attach the adjust plate ① to the bottom of the needle holder assembly with the screw ①.

**\*Key point**

- Align the bottom of the needle roller pin with the slot on the adjust plate ①, and then move them so that the adjust plate ① is level with the side face of the needle holder assembly.

①		Screw, Bind M2.6X5	Torque 0.20 - 0.49 N·m
---	---	-----------------------	---------------------------

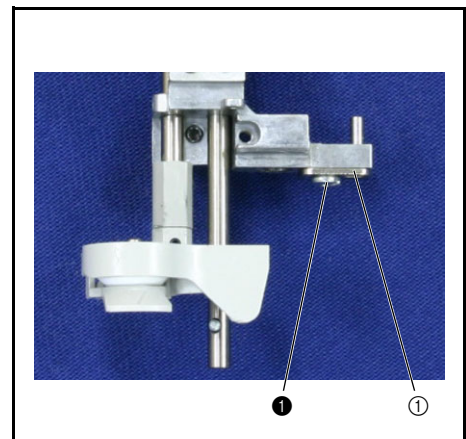

### 20 Shaft bushing A attachment

1. Attach the shaft bushing A ① to the unit holder with the screw ①.

**\*Key point**

- Insert the shaft bushing A into the unit holder.

①		Taptite, Bind B M3X8	Torque 0.58 - 0.78 N·m
---	---	-------------------------	---------------------------

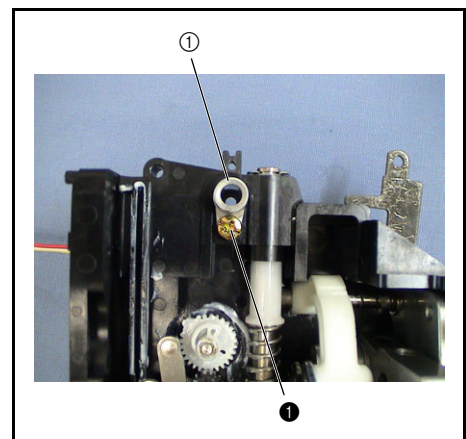

### 21 Lever AB unit assembly

1. Attach the needle threader driving plate ② to the lever AB assembly ① with the screws ①.

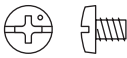
<b>①</b>		Screw, Bind M3X4	Torque 0.78 – 1.18 N·m
----------	---	---------------------	---------------------------

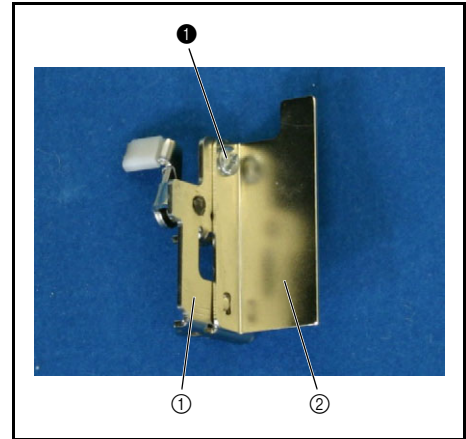

### 22 Lever AB ASSY assembly

1. Attach the cap ② to the lever B ①.
2. Attach the lever B ① and the spring S08 to the lever A assembly ③, and then attach the retaining ring (E3).

<b>S08</b>		TORSION SPRING XC2460***
------------	---	-----------------------------

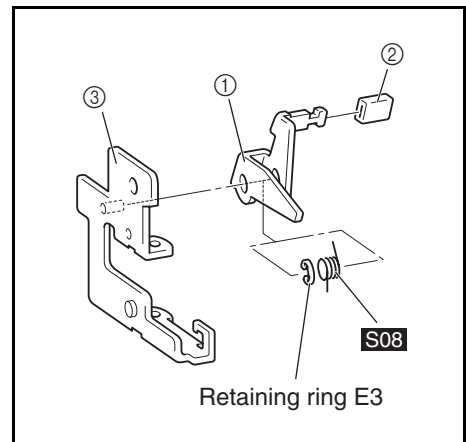

Assembly

**23** Lever AB assembly attachment

1. Attach the retaining ring (E2) to the groove on the inside of the lever guide shaft ①.
2. Apply a light covering of EPNOC AP (N)0 to the surface of the lever guide shaft ①.
3. Place the lever AB assembly ② onto the lever guide shaft ①.
4. Apply a light covering of MOLYKOTE EM30L to the slide groove ③ of the unit holder.
5. Insert the lever guide shaft ① into the shaft hole on the unit holder, and then insert the slider ④ of the lever AB assembly ② into the slide groove ③ of the unit holder.
6. Place the lever supporter plate ⑤ beneath the lever guide shaft ①, and then attach the lever supporter plate ⑤ to the unit holder with the screw ①.
7. Attach the retaining ring (E2) to the lever guide shaft ① from the rear of the unit holder.

Apply EPNOC AP (N)0 to the surface of the lever guide shaft.	Light covering XC8387***
Apply MOLYKOTE EM30L to the slide groove of the unit holder.	Light covering XC8385***

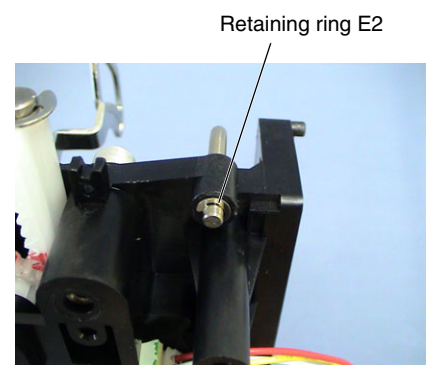
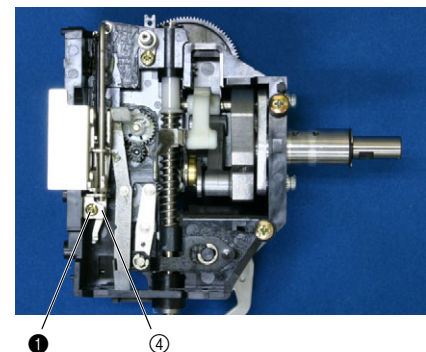
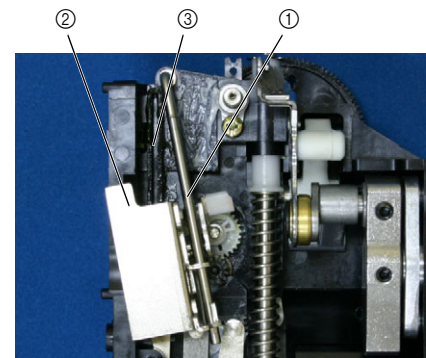
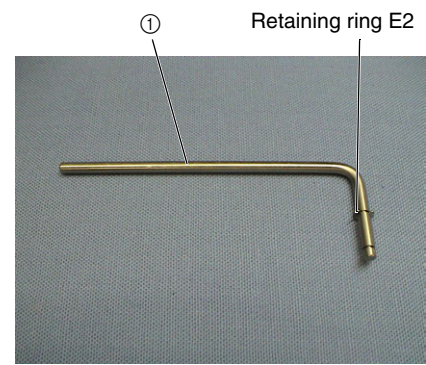

<b>①</b>		Taptite, Pan B M3X6	Torque 0.58 – 0.78 N·m
----------	---	------------------------	---------------------------

### 24 Threader lever SW unit attachment

1. Attach the threader lever switch ② and the presser switch holder ③ to the switch lever plate ① with the screw ①.
2. Attach the unit holder ④ with the screw ②.

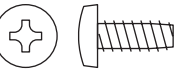
①		Screw, Bind M3X4	Torque 0.78 - 1.18 N·m
②		Tapite, Bind B M4X10	Torque 1.18 - 1.57 N·m

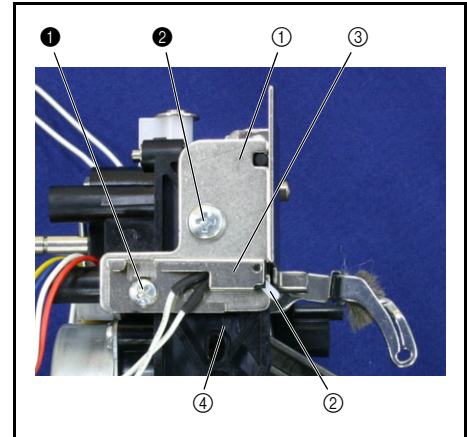

### 25 Needle bar assembly

1. Attach the needle thread plate ① to the needle block ②.
2. Attach the needle block ② to the needle bar ③ with the screw ①.

**\*Key point**



- The screw ① is on the right-hand side when the needle bar groove is facing the front.

3. Attach the needle bar thread guide ④ to the needle bar ③ with the screw ②.

**\*Key point**

- There should be no clearance ⑤ on the right side of the needle bar thread guide ④ and the needle block ②.
- There should be a clearance of 0.2 mm to 0.5 mm on the left side of the needle bar thread guide ④ and the needle block ②.

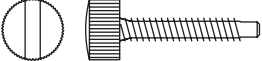
Clearance on right side of needle bar thread guide and needle block	None
Clearance on left side of needle bar thread guide and needle block	0.2 mm to 0.5 mm

①		Needle Clamp Screw	—
②		Screw SM2.38	Torque 0.39 - 0.78 N·m

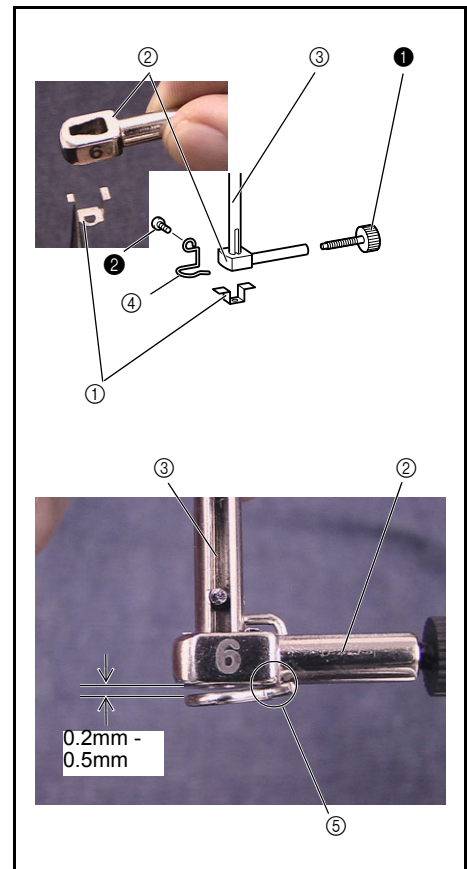

Assembly

## 26 Needle holder ASSY assembly

1. Apply a bead of MOLYKOTE EM30L to the needle bar hook ② of the needle bar block ①.
2. Insert the needle bar assembly ③ from the bottom of the needle holder assembly, and then insert the needle bar block ①.
3. Apply a small bead of EPNOC AP (N)0 to the groove on the needle thread block ④.
4. Insert the needle thread block ④ into the needle bar assembly ③, and then tighten the screw ① temporarily.
5. Adjust the needle threader, and then fully tighten the screw ①.

**\*Key point**

- Refer to "Needle threader adjustment" on page 4 - 10 for the adjustment procedure.

6. Insert the needle bar hook stand assembly ⑤ into the needle bar assembly ③, and then tighten the screw ① temporarily.
7. Adjust the needle bar height, and then fully tighten the screw ①.

**\*Key point**

- Refer to "Needle bar height adjustment" on page 4 - 9 for the adjustment procedure.

8. Attach the spring S43 and the thrust washer ⑥ to the needle bar assembly ③, and then pass the needle bar assembly completely through the shaft hole on the needle holder assembly.

**\*Key point**

- Position the spring S43 with the end with the smaller diameter facing up.

9. Dip the needle bar operating section of the needle holder assembly in OILER B ASSY.

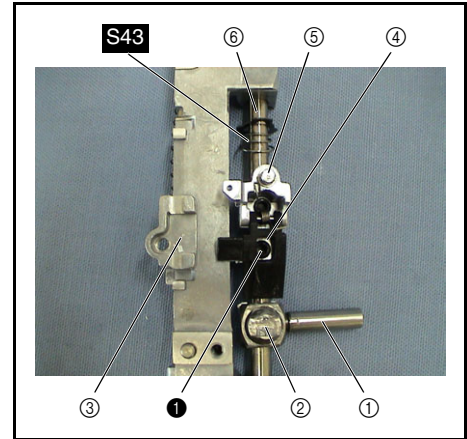

Apply MOLYKOTE EM30L to the needle bar hook of the needle bar block.	Bead XC8385***
Apply EPNOC AP (N)0 to the groove on the needle thread block.	Small bead XC8387***
Dip the needle bar operating section of the needle holder assembly in OILER B ASSY.	Dipping XZ0206***

①		Set Screw, Socket (FT) M4X4	Torque 0.98 N·m
S43		NEEDLE BAR PRESSER SPRING XC6254***	



### 27 Release lever ASSY assembly

1. Attach the retaining ring (E2.5) to the groove on the release lever shaft ①.
2. Attach the thrust washer ② and the release lever ③ to the release lever shaft ①.
3. Apply a light covering of MOLYKOTE EM30L to the oscillating section of the release lever's needle bar hook stand assembly ④.
4. Apply a small bead of EPNOC AP (N)0 to the tab on the rear of the oscillating section of the release lever's needle bar hook stand assembly ⑤.

Apply MOLYKOTE EM30L to the oscillating section of the release lever's needle bar hook stand assembly.	Light covering XC8385***
Apply EPNOC AP (N)0 to the tab on the rear of the oscillating section of the release lever's needle bar hook stand assembly.	Small bead XC8387***

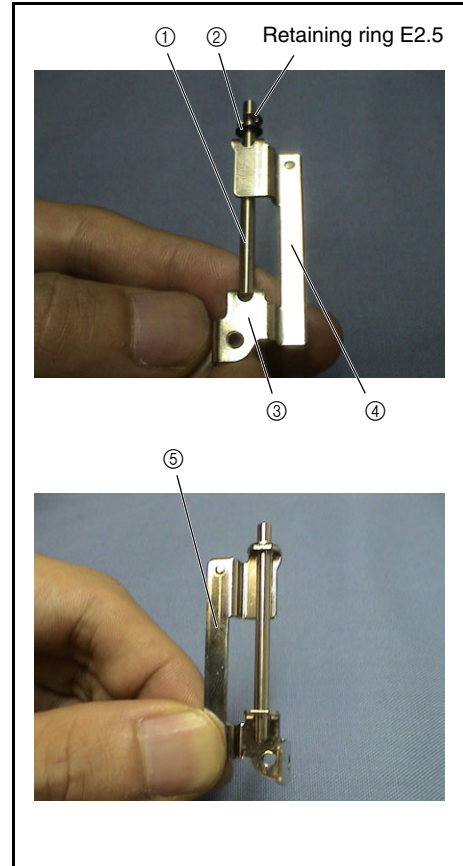

Assembly

### 28 Release lever assembly attachment

1. Attach the release lever assembly ① to the needle holder assembly (the position shown in the illustration on the right) with the screw ①.

**\*Key point**

- Tighten the screw ① while lightly pressing the release lever shaft of the release lever assembly ① from the top.

①		Screw, Pan (SIP washer) M3X6B	Torque 0.58 – 0.78 N•m
---	--	----------------------------------	---------------------------

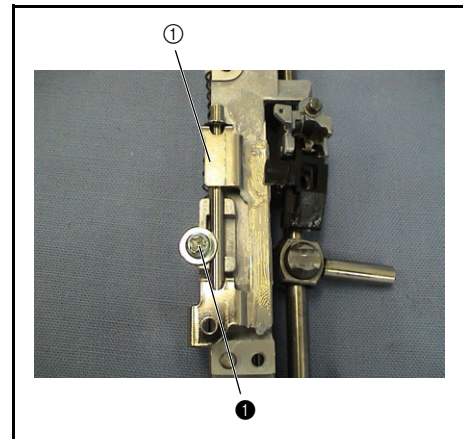

### 29 Release lever spring attachment

1. Attach the spring S40 from the top of the release lever shaft ③.

**\*Key point**

- Attach the straight section of the spring S40 to the groove on the needle holder assembly ①.
- Attach the hook of the spring S40 to the release lever ②.

S40		RELEASE LEVER SPRING XC3448***
-----	--	-----------------------------------

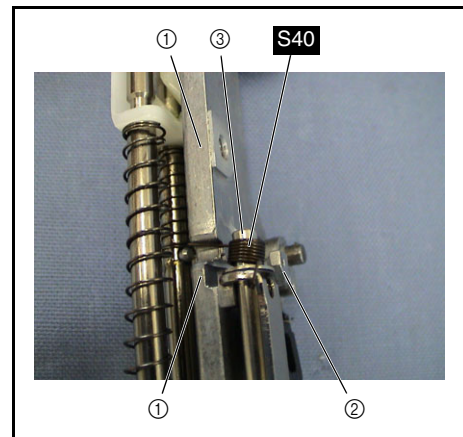



### 30 Release guide plate attachment

1. Apply a light covering of EPNOC AP (N)0 to the groove on the release guide plate ①.
2. Attach the release guide plate ① to the needle holder assembly (in the position shown in the photo on the right) with the screw ❶.

**\*Key point**

- Engage the tab on the needle bar hook stand assembly ② with the groove on the release guide plate ①.

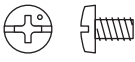
Apply EPNOC AP (N)0 to the groove on the release guide plate.		Light covering XC8387***	
❶		Screw, Bind M3X5	Torque 0.79 – 1.18 N·m

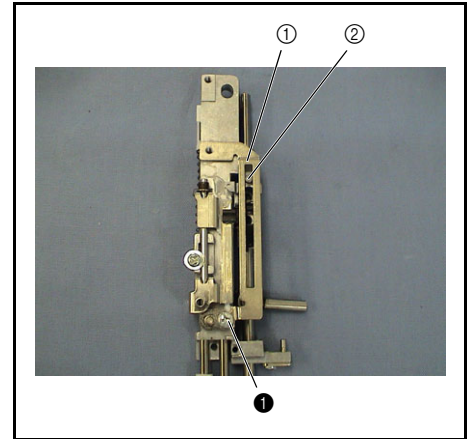

### 31 Release adjuster attachment

1. Attach the release adjuster ① to the needle holder assembly (the position shown in the illustration on the right), and then tighten the 2 screws ❶ temporarily.
2. Adjust the needle bar hook height, and then fully tighten the 2 screws ❶.

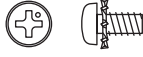
❶		Screw, Pan (T washer) M3X6	Torque 0.19 – 0.29 N·m
---	---	----------------------------	------------------------

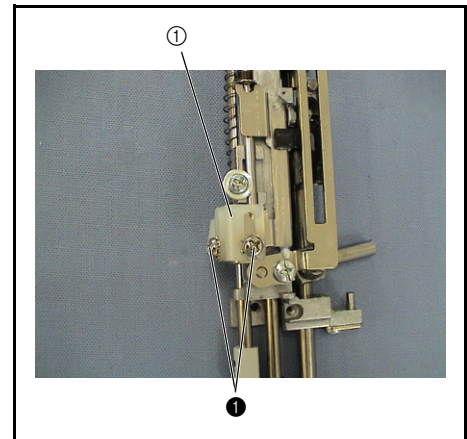

### 32 Hook release plate attachment

1. Attach the hook release plate ① to the rear of the needle holder assembly with the screw ❶.

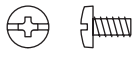
❶		Screw, Bind M2.6X5	Torque 0.20 – 0.49 N·m
---	---	--------------------	------------------------

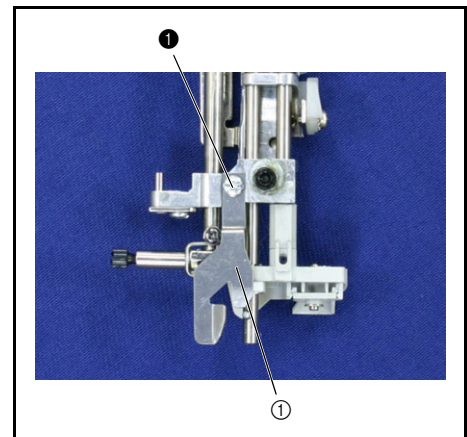

### 33 Needle holder assembly attachment

1. Apply 1 or 2 drops of MOLYKOTE (OILER B ASSY 90% + MOLYKOTE M DISPERSION 10%) to the shaft of the needle bar block ②.
2. Insert the needle holder assembly ① from the top of the unit holder.
3. Insert the shaft of the needle bar block ② into the crank rod ③.
4. Apply 1 or 2 drops of FBK OIL RO 100 to the shaft A ④.
5. Insert the shaft A ④ into the shaft bushing ⑤ of the unit holder from the shaft hole on the top of the needle holder assembly.

**\*Key point**

- Insert the shaft A ④ from the end without a shaft hole.

6. Insert the shaft C ⑥ into the shaft hole at the upper right side of the needle holder assembly ①, and pass it through the shaft hole on the shaft A ④.

**\*Key point**

- Insert the shaft C ⑥ from the end with a groove.
- Cross the shaft A ④ and the shaft C ⑥.

7. Attach the plate ⑦ to the needle holder assembly ① with the screw ①.

**\*Key point**

- Attach the U-shaped section of the plate ⑦ to the groove on the shaft C ⑥.

8. Attach the screw ② to the tip of the shaft A ④.

Apply MOLYKOTE (OILER B ASSY 90% + MOLYKOTE M DISPERSION 10%) to the shaft of the needle bar block.	1 - 2 drops XZ0206*** XC8386***
Apply FBK OIL RO 100 to the shaft.	1 - 2 drops XC8388***

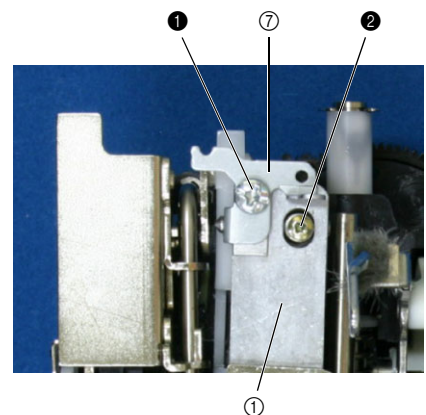
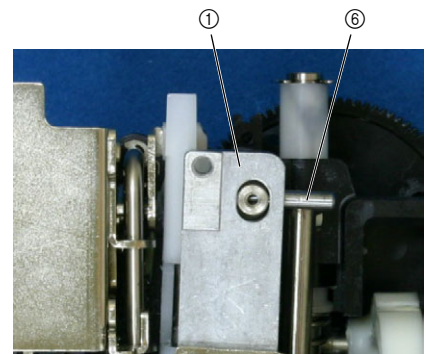
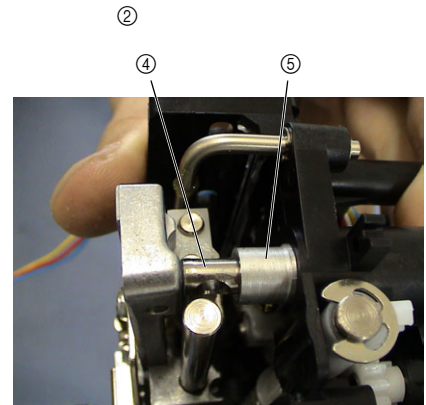
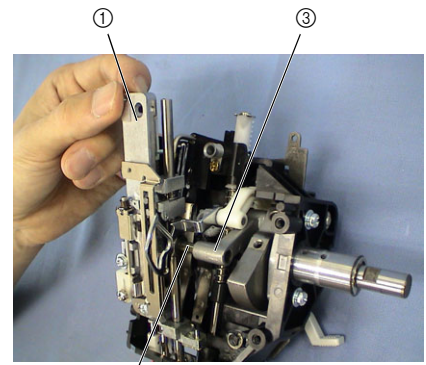

①		Screw, Bind M3X5	Torque 0.78 – 1.18 N·m
②		Screw, Bind M2X4	Torque 0.39 – 0.78 N·m

### 34 Spring attachment

1. Attach the spring **S42** to the plate ① and the needle bar hook stand assembly ②.
2. Attach the guard plate ③ with the screw ①.

**\*Key point**

- Attach the spring **S42** in the following direction:  
 Plate ① ⇒ From the left side  
 Needle bar hook stand assembly ② ⇒ From the front side

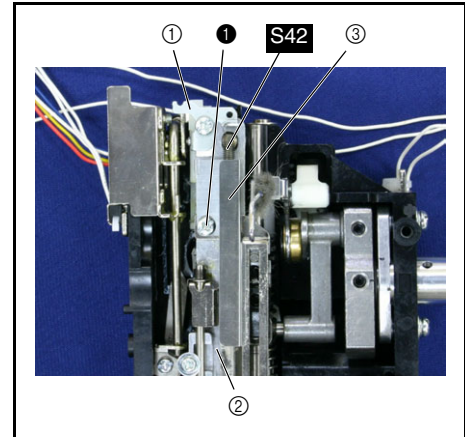
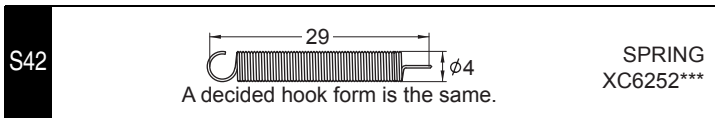

### 35 Spring attachment

1. Attach the spring **S62** to the plate ① and the lever AB assembly ②.

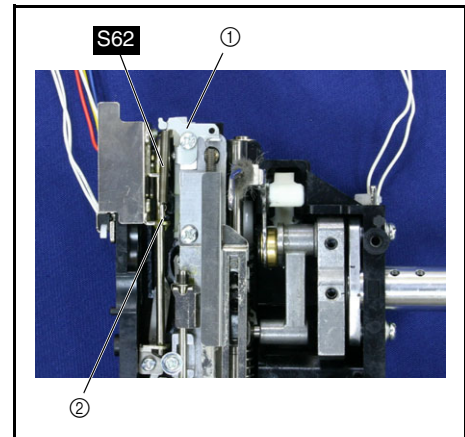
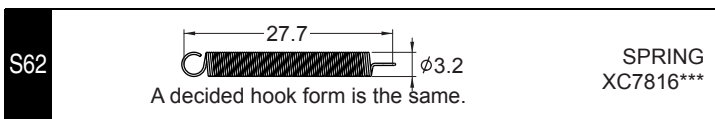

### 36 Needle holder shaft block attachment

1. Apply a small bead of EPNOC AP (N)0 to the needle roller ① of the needle holder assembly.
2. Insert the needle holder block ② into the needle roller ①.

**\*Key point**

- Position the needle holder block ② with the flat face on the bottom.

3. Apply a small bead of EPNOC AP (N)0 to the shaft of the needle holder shaft block ③.
4. Attach the thread guide plate ④ to the unit holder
5. Insert the shaft of the needle holder shaft block ③ into the shaft hole on the needle holder block ② and the slot on the unit holder.
6. Temporarily tighten the screw ❶ to the needle holder shaft block ③ from the bottom of the unit holder.
7. Adjust the clearance between the needle and the rotary hook point, and then fully tighten the screw ❶.

**\*Key point**

- Refer to "Clearance between needle and rotary hook point adjustment" on page 4 - 11 for the adjustment procedure.

Apply EPNOC AP (N)0 to the needle roller of the needle holder assembly.	small bead XC8387***
Apply EPNOC AP (N)0 to the shaft of the needle holder shaft block.	small bead XC8387***

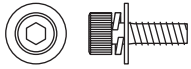
❶		Screw 3X10	Torque 0.98 N·m
---	---	---------------	--------------------

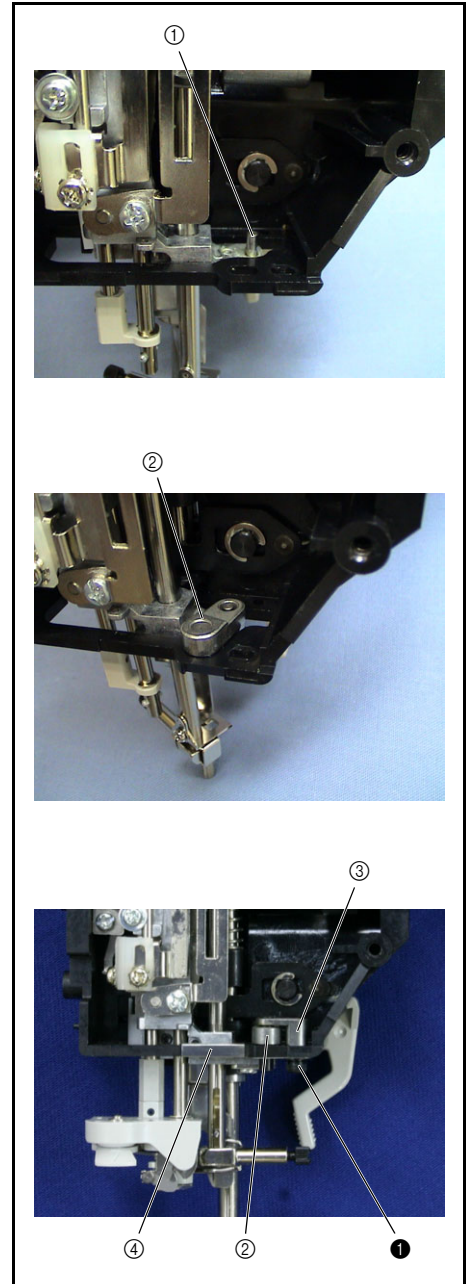

### 37 Spring-Z attachment

1. Attach the spring **S20** to the left side of the unit holder ① and the needle holder ②.

**\*Key point**

- Attach the unit holder end of the spring **S20** to the position below the tab on the left side of the unit holder.

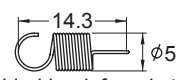
<b>S20</b>		SPRING-Z XC2748***
A decided hook form is the same.		

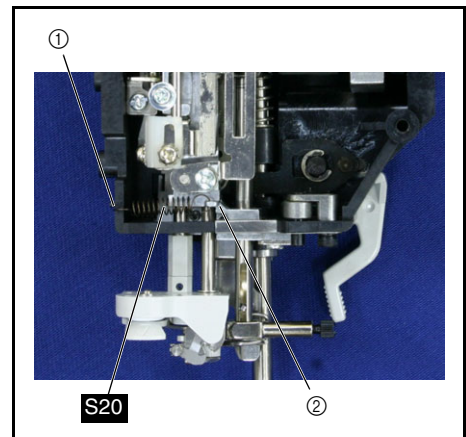



### 38 Spring attachment

1. Attach the spring **S10** to the plate ① and the groove at the upper section of the unit holder ②.

**\*Key point**

- Attach the end with the shorter hook to the plate ① and the end with the long hook to the unit holder ②.

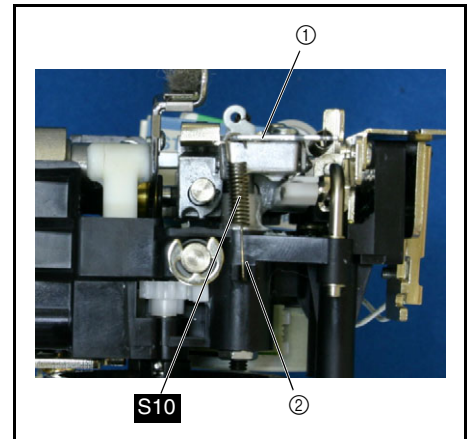
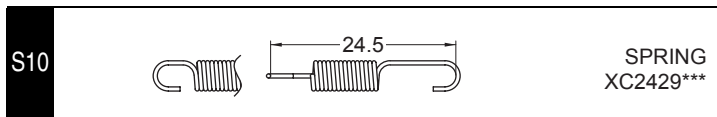

### 39 Zigzag adjusting nut attachment

1. Apply a light covering of EPNOC AP (N)0 to the cylindrical section of the zigzag adjusting nut ①.
2. Attach the zigzag adjusting nut ① to the rear of the needle holder, and then tighten the screw ❶ temporarily.

**\*Key point**

- Position the zigzag adjusting nut ① with the larger eccentric section (section shifted from the center) on the top.

3. Adjust the 3 needle drop points, and then fully tighten the screw ❶.

**\*Key point**

- Refer to "Three point needle drop adjustment" on page 4 - 6 for the adjustment procedure.

Apply EPNOC AP (N)0 to the entire circumference of the zigzag adjusting nut's cylindrical section.	Light covering XC8387***
--	-----------------------------

❶		Bolt, Socket M3X10	Torque 0.78 – 1.18 N·m
---	--	-----------------------	---------------------------

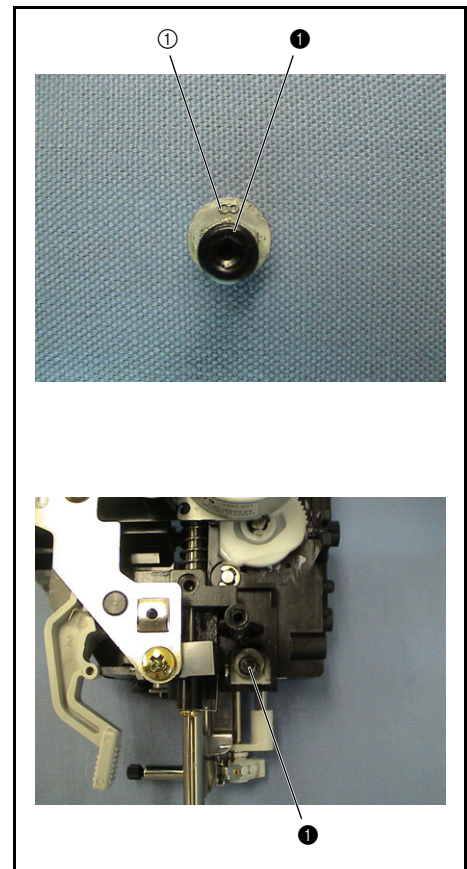

## 40 Lock nut attachment

1. Attach the lock nut ① to the screw ①.

**\*Key point**

- Thread the lock nut ① to the mid point of the screw ①.

2. Attach the screw ① to the upper rear section of the unit holder.

**\*Key point**

- Tighten the screw ① until the lock nut ① contacts the unit holder.

①		Set Screw, Socket (CP) M4X12	Torque 0.39 – 0.49 N·m
---	---	---------------------------------	---------------------------

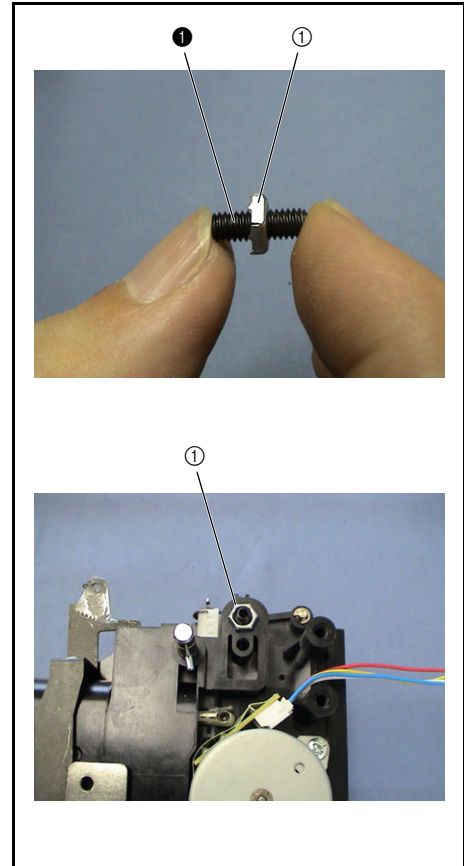



**41 PT holder ASSY**

1. Insert the cloth thickness sensor assembly ① from the bottom of the PT holder ②.
2. Attach the plain washer (M6) ③ and the #1 nut ④ to the shaft of the cloth thickness sensor assembly ①, and then tighten the #1 nut ④.
3. Attach the spring S61 to the shaft of the cloth thickness sensor assembly ①.

**\*Key point**

- Position the spring S61 with the end that has an obtuse hook on the bottom.

4. Attach the lower hook of the spring S61 to the spring hole ⑤ on the PT holder ②.
5. Attach the upper hook of the spring S61 to the PT lever ⑥, and then insert the PT lever ⑥ into the shaft of the cloth thickness sensor assembly ①.
6. Secure the PT lever ⑥ with the screw ①.

**\*Key point**

- Align the shaft end of the cloth thickness sensor assembly ① with the top face of the PT lever ⑥.

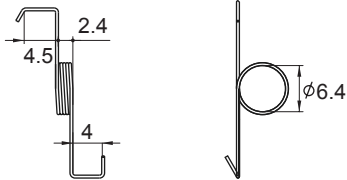
①		Set Screw, Socket (FT) M3X6	Torque 0.59 – 0.78 N·m
S61			SPRING XA1894***

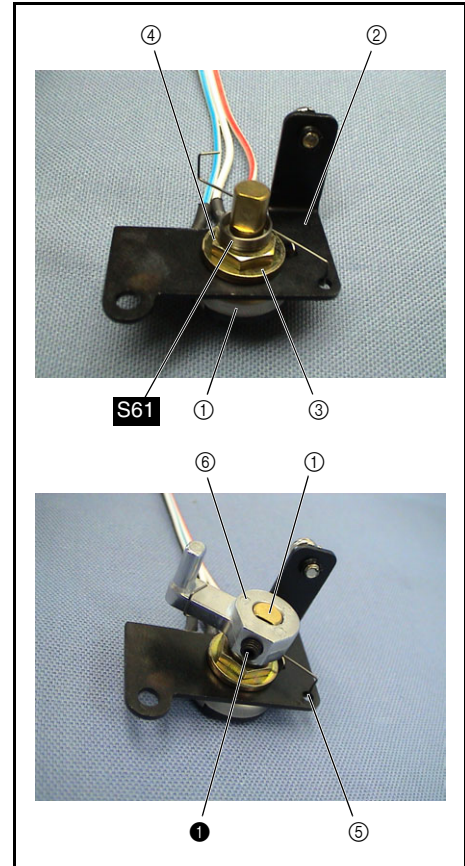



## 42 PT holder assembly attachment

1. Temporarily attach the screw ❶ to the screw hole on the side face of the PT holder assembly ❶.
2. Attach the PT holder assembly ❶ to the unit holder with the screw ❷.

### \*Key point

- Place the PT lever ❷ of the PT holder assembly ❶ on the presser bar clamp ❸.
3. Fully tighten the screw ❶.

❶		Screw, Pan (S/P washer) M3X5	Torque 0.39 – 0.58 N·m
❷		Taptime, Bind B M3X8	Torque 0.58 – 0.78 N·m

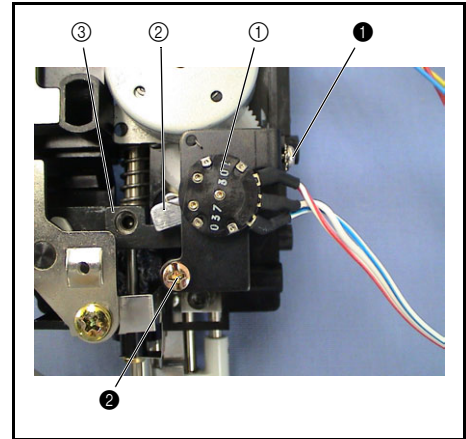

## 43 BHSW D6 switch assembly and LED PCB D6 assembly attachment

1. Attach the BHSW D6 switch assembly ❶ with the screw ❶.

### \*Key point

- Engage the positioning tab on the side of the unit holder with the positioning hole on the BHSW D6 switch assembly ❶.
2. Attach the lamp holder ❷ and the LED PCB D6 assembly ❸ with the screw ❶.

❶		Taptime, Pan B M4X12	Torque 0.39 – 0.58 N·m
---	---	-------------------------	---------------------------

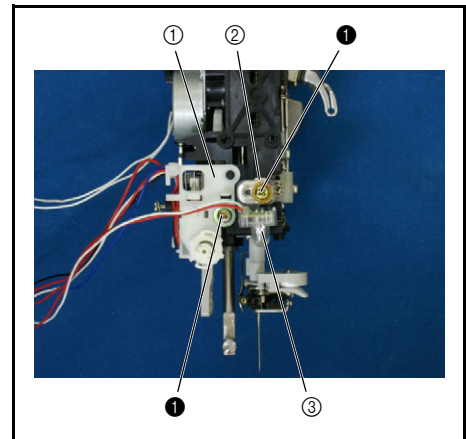

### 44 Presser dial attachment

1. Raise the presser foot ①.
2. Insert the presser dial ② into the presser dial shaft assembly ③ on the rear of the unit holder, and then attach the retaining ring (E4).
3. Insert the 2 plain washers ④ and the spring washer ⑤ into the presser dial ②.

**\*Key point**

- Engage the pin of the presser dial shaft assembly ③ with the positioning groove on the rear of the presser dial ②.
- Attach the presser dial ② so that the shutter ⑥ of the presser dial is on the left.

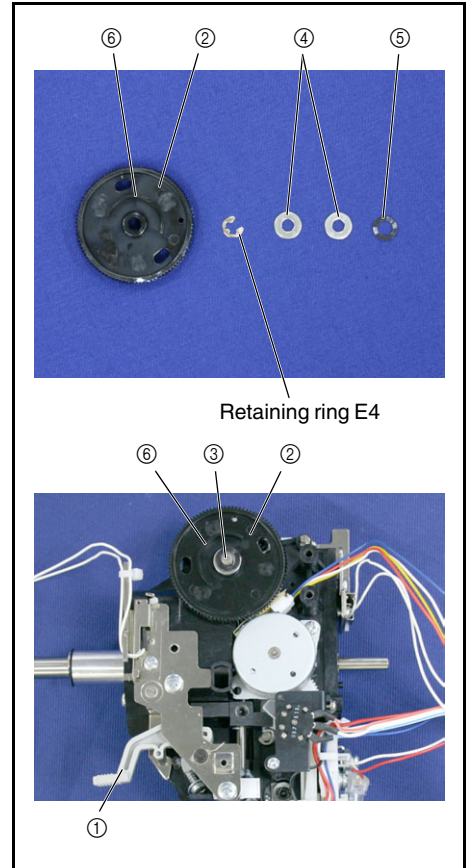

### 45 Presser pulse motor holder ASSY assembly

1. Apply 1 or 2 drops of FBK OIL RO 100 to the shaft of the presser pulse motor ①.
2. Insert the presser pulse motor lead wire assembly ② into the connector of the presser pulse motor ①.
3. Attach the presser pulse motor assembly ② to the presser pulse motor holder ④ with the 2 screws ①.

**\*Key point**

- Position the PCB of the presser pulse motor ① to the right.

4. Attach the ATPF INIT PCB assembly ③ to the presser pulse motor holder ④ with the screw ②.

**\*Key point**

- Engage the positioning tab on the presser pulse motor holder ④ with the U-shaped notch (the one far from the screw) on the ATPF INIT PCB assembly ③.
- Tighten the screw ② at the center of the slot on the ATPF INIT PCB assembly ③.

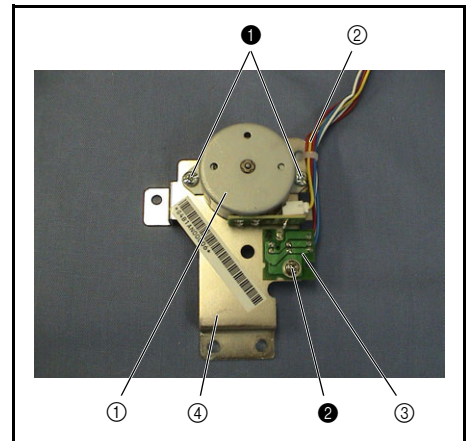

Apply FBK OIL RO 100 to the shaft of the presser pulse motor.	1 - 2 drops XC8388***
---	-----------------------

①		Screw, Bind M3X4	Torque 0.58 – 0.78 N·m
②		Screw, Pan (SIP washer) M3X5	Torque 0.58 – 0.78 N·m

## 46 Presser pulse motor holder assembly attachment



1. Attach the presser pulse motor holder assembly ① to the unit holder with the screws ① and ② (2 for ②).

### \*Key point

- Tighten the screws ① and ② in the following order: ① (temporarily tighten), ② (fully tighten both), and ① (fully tighten).

### NOTE

- Check that there is no grease adhered to the shutter of the presser dial.
- Check that the shutter of the presser dial is almost centered relative to the sensor of the ATPF INIT PCB assembly.

①		Screw, Bind M4X5	Torque 1.18 – 1.57 N·m
②		Tapite, Bind B M4X10	Torque 0.58 – 0.78 N·m

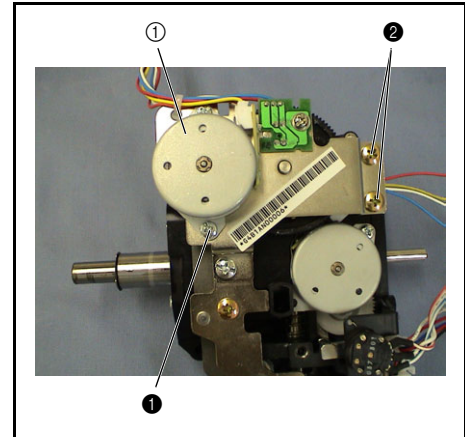

### 47 Threader hook assembly attachment

1. Assemble the threader hook assembly ①, link A assembly ②, link B assembly ③, and thread guide assembly ④.
2. Align the pin of needle threader shaft A ⑤ with the shaft hole on the threader hook assembly ①, and then attach the threader hook assembly ① to needle threader shaft ⑤.

**\*Key point**

- Assemble the link A assembly ②, link B assembly ③, and thread guide assembly ④ so that a triangle is formed.

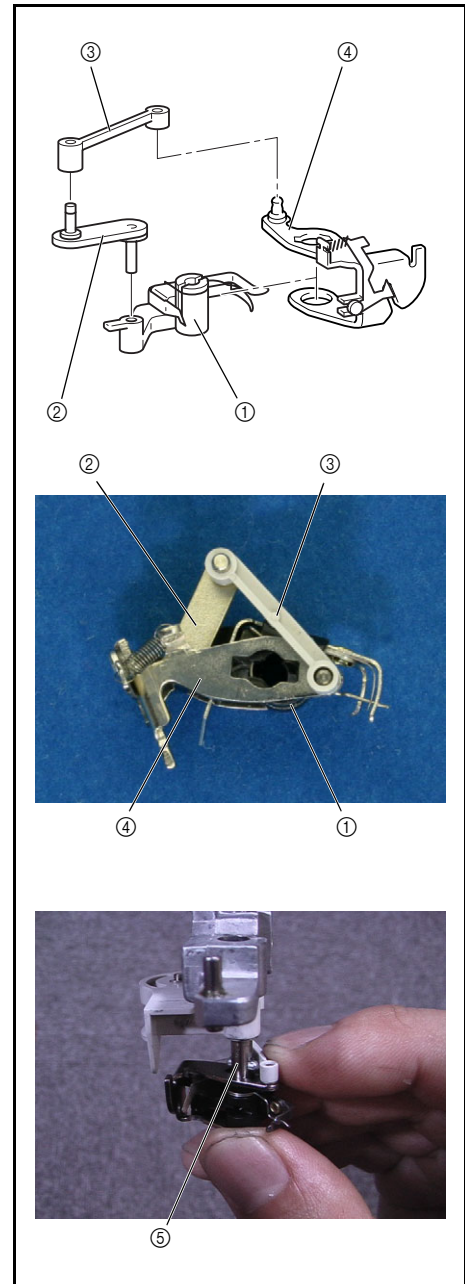

### 48 Presser feed holder attachment

1. Temporarily attach the screw ❶ to the presser feed holder assembly ①.
2. Move the presser feed holder assembly ① upward, and then tighten the screw ❶.
3. Attach the presser foot ②.

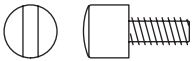
❶		Screw 3.57	Torque 1.18 – 1.57 N·m
---	---	---------------	---------------------------

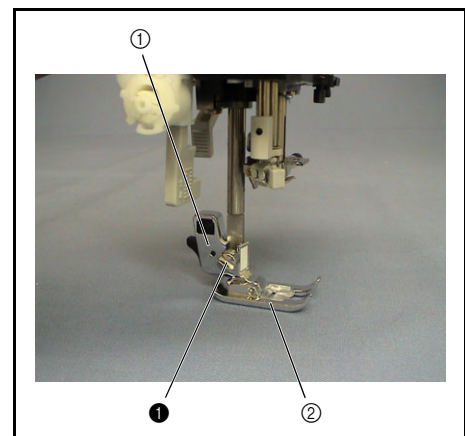



Main parts location diagram

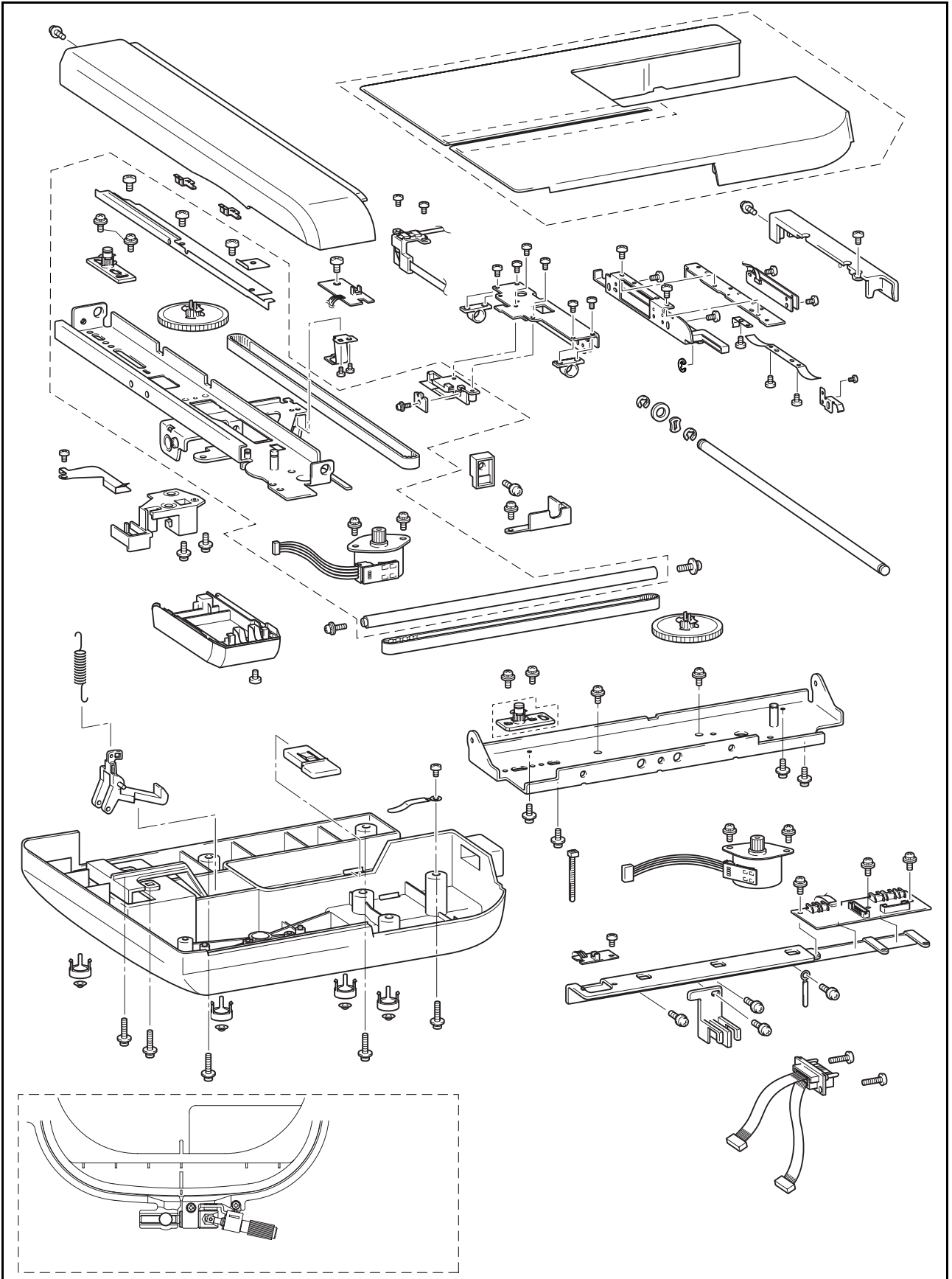



Assembly

### 1 Y sensor PCB assembly attachment

1. Attach the Y sensor PCB ① assembly to the X carriage assembly ② with the screws ①.

**\*Key point**

- Engage the positioning tab on the X carriage assembly with the positioning notch on the Y sensor PCB assembly ①.

①	 	Screw, Bind M3X6	Torque 0.59 – 0.79 N·m
---	---	---------------------	---------------------------

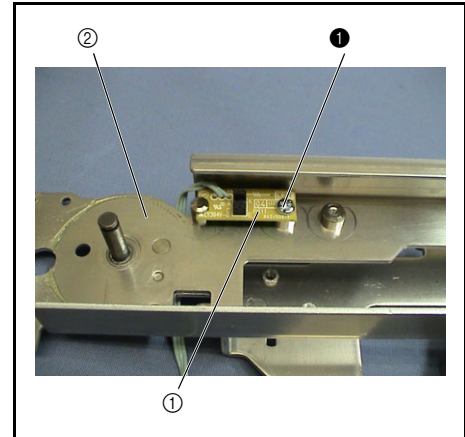



### 2 FFC cord guide attachment

1. Attach the FFC cord guide ① and the FCC cord supporter ② to the inside of the X carriage assembly ③ with the 3 screws ①.

**\*Key point**

- Secure the FFC cord supporter ② to the screw on the left.
- Tighten the screws ① in the following order: ①-1 (temporarily tighten), ①-2 (fully tighten), ①-3 (fully tighten), and ①-1 (fully tighten).

①	 	Screw, Bind M3X6	Torque 0.59 – 0.79 N·m
---	---	---------------------	---------------------------

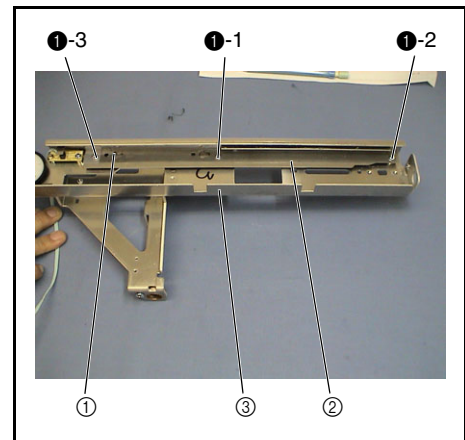

### 3 Y driving gear pulley assembly attachment

1. Apply a bead of EPNOC AP (N)0 to the shaft of the X carriage assembly.
2. Place the driving gear pulley assembly ① onto the shaft of the X carriage assembly.

**\*Key point**

- Position the driving gear pulley assembly ① with the pulley on the top.
- Slide the driving gear pulley assembly ① until the hook catches in the groove on the shaft of the X carriage assembly (a click can be heard).

Apply EPNOC AP (N)0 to the shaft of the X carriage assembly.	Bead XC8387***
--	-------------------

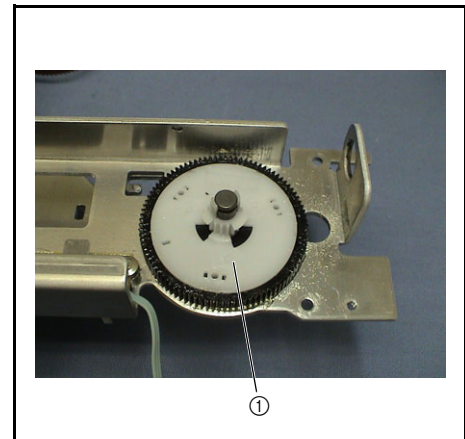

#### 4 Y slider assembly attachment

1. Attach the YT belt presser plate ① to the Y slider ③ with the tab ② on the bottom.
2. Temporarily tighten the screw ❶ in the YT belt presser plate ①.
3. Place the timing belt (Y belt) ④ between the Y slider ③ and the YT belt presser plate ①.

**\*Key point**

- Align the ridge on the Y slider ③ with the trough on the timing belt (Y belt) ④.
4. Fully tighten the screw ❶.

❶		Screw, Pan (SIP washer) M4X8	Torque 1.18 – 1.57 N·m
---	--	---------------------------------	---------------------------

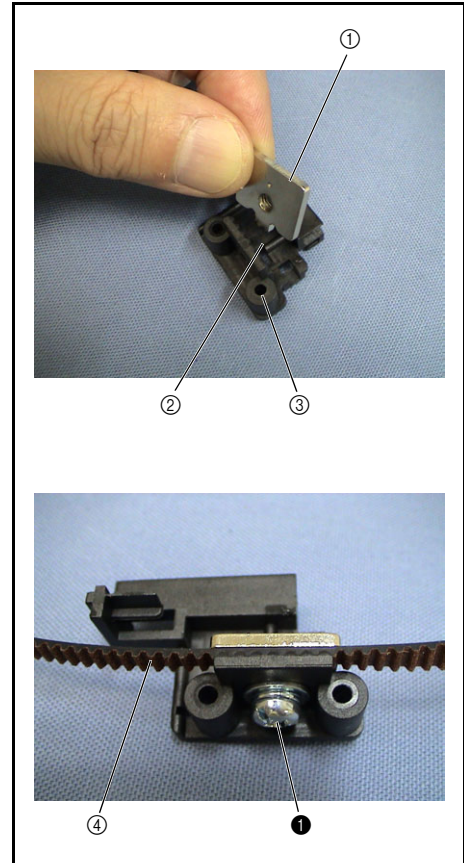

#### 5 Y tension pulley assembly attachment

1. Hang one end of the timing belt (Y belt) ① over the driving gear pulley assembly ②.
2. Place the Y slider ③ over the Y sensor PCB assembly ④, and then insert the guide ⑥ on the X carriage assembly into the groove ⑤ on the Y slider ③.
3. Hang the other end of the timing belt ① over the tension pulley assembly ⑦, and then attach the tension pulley assembly ⑦ to the left side of the X carriage assembly with the 2 screws ❶.

**\*Key point**

- Move the tension pulley assembly ⑦ to the left to attach it.
- Tighten the screw ❶ on the right lightly (0.19 - 0.39 Nm).
- Refer to "Y-belt tension adjustment" on page 4 - 29 for the tension adjustment procedure.

❶		Screw, Pan (SIP washer) M4X8	Torque 0.19 – 0.39 N·m 1.18 – 1.57 N·m
---	---	---------------------------------	--

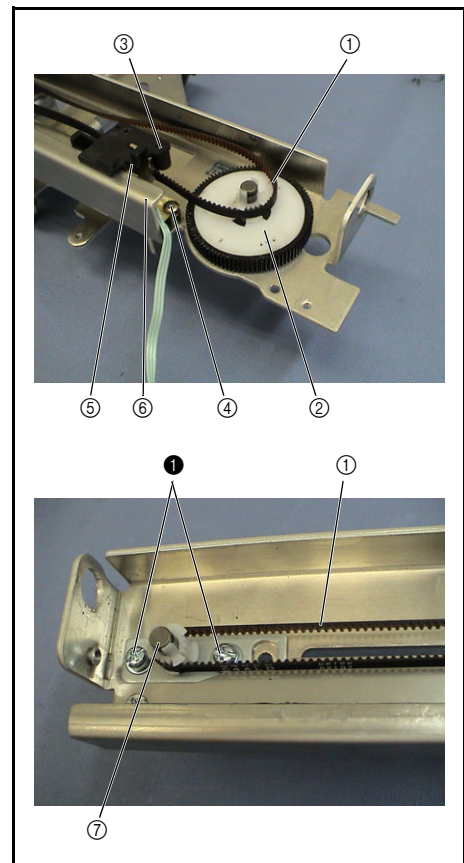

## 6 Y pulse motor attachment

1. Apply 1 or 2 drops of FBK OIL RO 100 to the bushing ① of the Y pulse motor assembly ②.
2. Attach the Y pulse motor assembly ② to the X carriage assembly with the 2 screws ①.

### \*Key point

- Position the Y pulse motor assembly ② so that the PCB is at the lower right section.
  - Insert the Y pulse motor assembly ② from the bottom of the X carriage assembly.
3. Apply a small bead of EPNOC AP (N)0 to 4 locations on the gear of the driving gear pulley assembly ③.

Apply of FBK OIL RO 100 to the bushing of the Y pulse motor.	1 - 2 drops XC8388***
Apply EPNOC AP (N)0 to 4 locations on the gear of the driving gear pulley assembly.	1 - 2 drops XC8387***

①		Screw, Pan (SIP washer) M3X7	Torque 0.79 – 1.18 N·m
---	---	---------------------------------	---------------------------

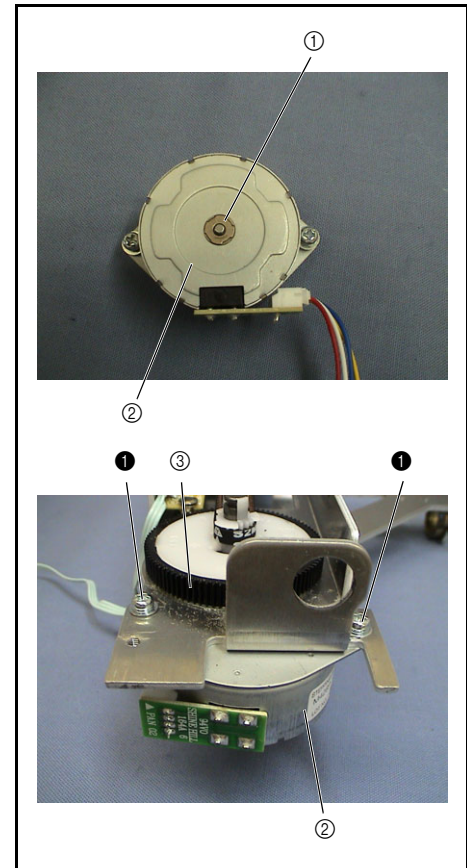

## 7 XC sub cover attachment

1. Attach the XC sub cover ① to the end of the X carriage assembly with the screw ①.

### \*Key point

- Hang the hook ② of the XC sub cover ① over the groove of the X carriage assembly.

①		Screw, Pan (SIP washer) M3X7	Torque 0.49 – 0.69 N·m
---	---	---------------------------------	---------------------------

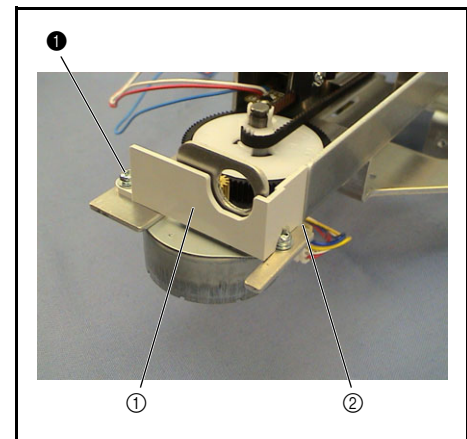



## 8 E hoop stay plate ASSY assembly

1. Attach the frame PCB assembly ① and the insulation sheet ② to the E hoop stay plate sub assembly ③ with the 2 screws ①.

### \*Key point

- Engage the positioning tab on the E hoop stay plate sub assembly ③ with the positioning hole on the frame PCB assembly ① and the insulation sheet ②.
  - Tighten the screws ① in the following order: ①-1 (temporarily tighten), ①-2 (fully tighten), and ①-1 (fully tighten).
2. Place the E hoop lock lever ④ onto the shaft of the E hoop stay plate sub assembly ③, and then attach the retaining ring (E4).
  3. Set the E hoop lock lever ④ horizontal, and then attach the E hoop lock lever spring ⑤ to the E hoop stay plate sub assembly ③ with the screw ②.

### \*Key point

- Engage the positioning pin on the E hoop stay plate sub assembly ③ with the positioning hole on the E hoop lock lever spring ⑤.
- Align the E hoop lock lever spring ⑤ with the bottom of the slot on the E hoop stay plate sub assembly ③.

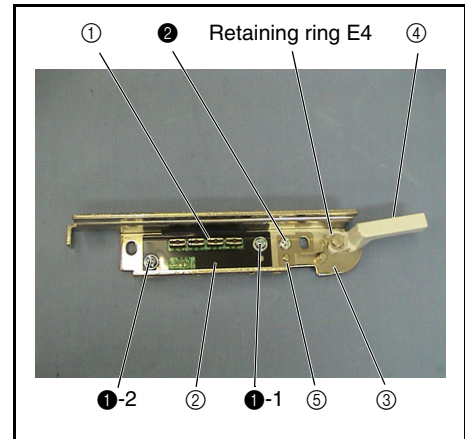

①		Screw, Pan (SIP washer) M3X7	Torque 0.59 – 0.79 N·m
②		Screw, Bind M3X4	Torque 0.98 – 1.18 N·m

## 9 E hoop pressure plate ASSY assembly

1. Attach E hoop presser spring C ① to the E hoop presser plate ② with the screw ①.

### \*Key point

- Engage the positioning tab on the E hoop presser plate ② with the positioning hole on E hoop presser spring C ①.
2. Attach E hoop presser spring A ③ to the E hoop presser plate ② with the 2 screws ①.

### \*Key point

- Engage the 2 positioning tabs on the E hoop presser plate ② with the corresponding positioning holes on E hoop presser spring A ③.

①		Screw, Bind M3X4	Torque 0.98 – 1.18 N·m
---	--	---------------------	---------------------------

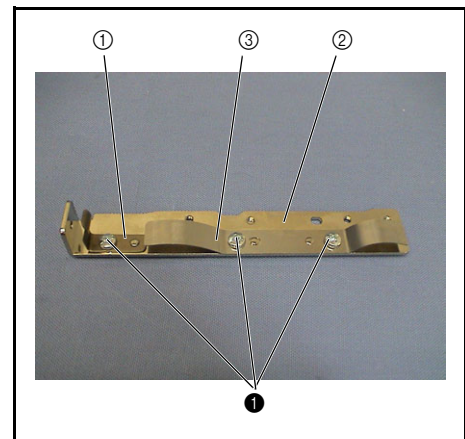



## 10 E hoop stay plate assembly attachment

1. Attach the E hoop stay plate ① to the Y carriage assembly with the 2 screws ①.

### \*Key point

- Align the 3 screws on the rear of the E hoop stay plate ① with the corresponding holes on the Y carriage assembly.
- Tighten the screws ① in the following order: ①-1 (temporarily tighten), ①-2 (fully tighten), and ①-1 (fully tighten).

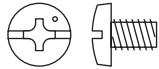
①		Screw, Bind M4X6	Torque 0.98 – 1.18 N·m
---	---	---------------------	---------------------------

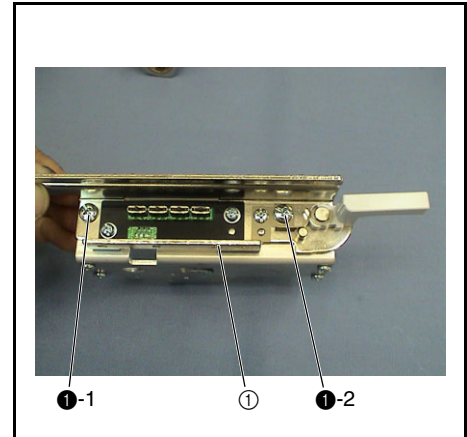

## 11 E hoop presser plate assembly attachment

1. Attach the E hoop presser plate assembly ① to the E hoop stay plate assembly ② with the 2 screws ①.

### \*Key point

- Attach the E hoop presser plate assembly ① to the lower section of the E hoop stay plate assembly ②.
- Engage the positioning tab on the E hoop presser plate assembly ① with the positioning hole on the E hoop stay plate assembly ②.
- Tighten the screws ① in the following order: ①-1 (temporarily tighten), ①-2 (fully tighten), and ①-1 (fully tighten).

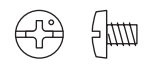
①		Screw, Bind M3X4	Torque 0.98 – 1.18 N·m
---	---	---------------------	---------------------------

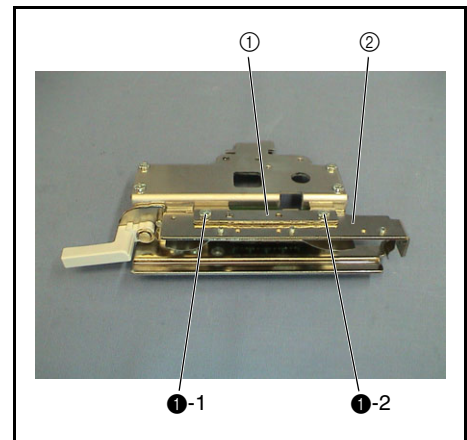

## 12 FFC support ASSY assembly

1. Bend the FFC cord ① (50 mm from the tip) with the black line facing out.
2. Insert the end of the FFC cord ① into the guide ③ on the FFC support ②, and pull the tip of the FFC cord ① until the black line passes through the guide ③.
3. Insert the end of the FFC cord ① into the guide ④ on the FFC support ②, and pull the tip of the FFC cord ① until a fold is created in the black line between the guide ③ and the guide ④.
4. Insert the other end of the FFC cord ① into the guide ⑥ and then pull the tip of the FFC cord ① until a fold ⑦ is created immediately before the guide ⑥.

### \*Key point

- Insert the other end of the FFC cord ① into the guide ⑥ with the rear of the cord (surface without the blue tag) facing you so that a fold is created as shown in the illustration on the right.
5. Fold the FFC cord ① back to the left at the exit of the guide ⑥.
  6. Fold the other end of the FFC cord ① with the red line facing in, and fold it back at a point 20 mm from the red line to create an N-shape.

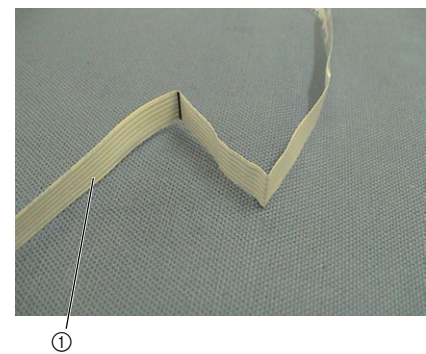
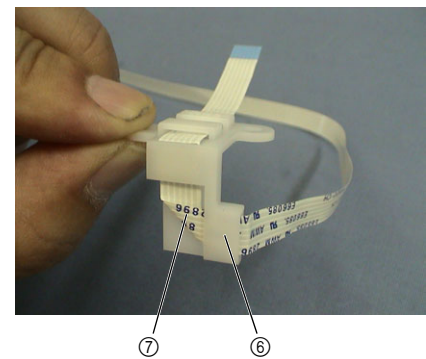
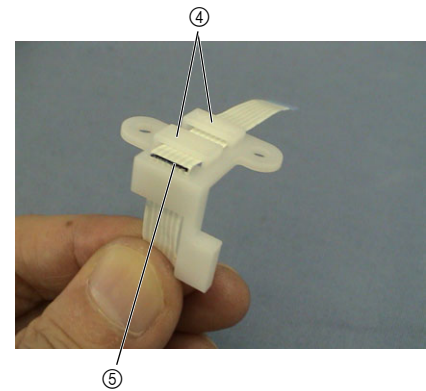
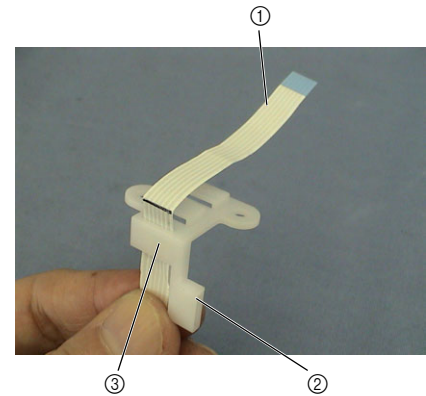

### 13 FFC support assembly attachment

1. Insert the FFC cord of the FFC support assembly ① into the connector of the frame PCB assembly ②.
2. Attach the FFC support assembly ① to the Y carriage assembly ③ with the 2 screws ①.

**\*Key point**

- Tighten the screws ① in the following order: ①-1 (temporarily tighten), ①-2 (fully tighten), and ①-1 (fully tighten).

①		Screw, Bind M3X6	Torque 0.59 – 0.79 N·m
---	---	---------------------	---------------------------

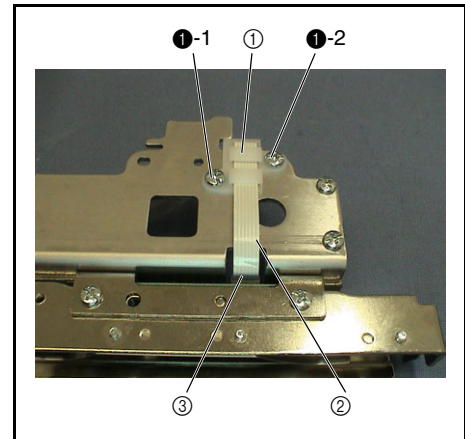

## 14 Y carriage assembly attachment

1. Attach the spring washer ② and the plain washer ③ to the Y guide shaft ① (from the end with the groove), and then attach the stop ring (10.69) to the outer groove.
2. Slide the Y slider ④ to the top of the Y sensor PCB ⑤.
3. Temporarily attach the Y carriage assembly ⑥ to the Y slider④.

### \*Key point

- Slide the frame ⑦ of the Y carriage assembly into the 2 grooves on the Y slider ⑧ to attach it.
- Do not tighten the screw at this point.

4. Insert the Y guide shaft ① (the end without the retaining ring) into the shaft hole on the left end of the X carriage assembly until it reaches the shaft hole at the right end.
5. Press the left end of the Y guide shaft ① to the right, and then attach the stop ring (10.69) to the inner groove.
6. Secure the Y carriage assembly ⑥ with the 2 screws ①.

### \*Key point

- Tighten the screws ① in the following order: ①-1 (temporarily tighten), ①-2 (fully tighten), and ①-1 (fully tighten).

### NOTE

- Check that the shutter of the Y slider ④ is almost centered relative to the sensor of the Y sensor PCB ⑤.

stop ring (10.69)

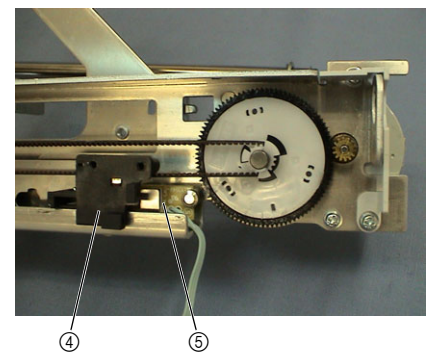
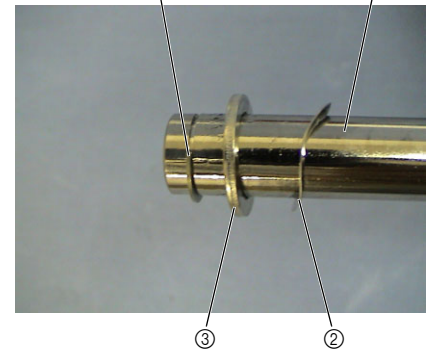

stop ring(10.69)

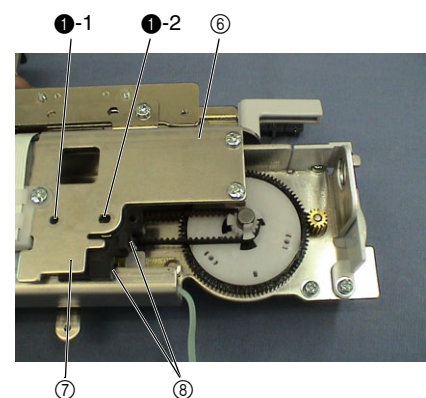
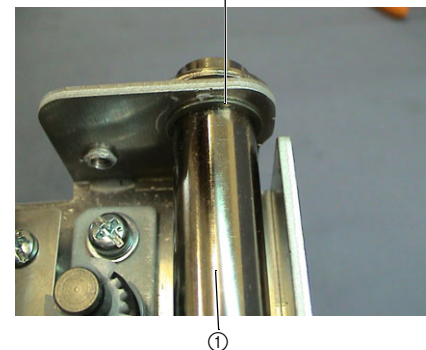

①			Taprite, Bind P M3X10	Torque 0.59 – 0.79 N·m
---	--	--	--------------------------	---------------------------

**15 FFC cord arrangement**

1. Slide the Y carriage assembly ① to the left as far as possible.
2. Thread the tip of the FFC cord ② from the left end of the X carriage assembly ③ into the Y slider.
3. Pull the tip of the FFC cord ② until the FFC cord ② is inside the screw ④ on the left end of the X carriage assembly ③.

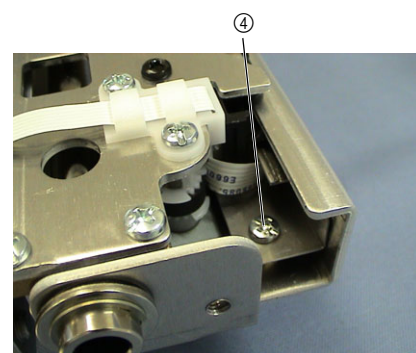
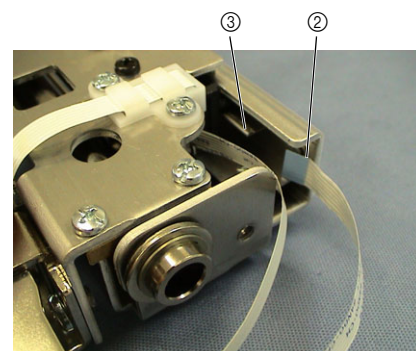
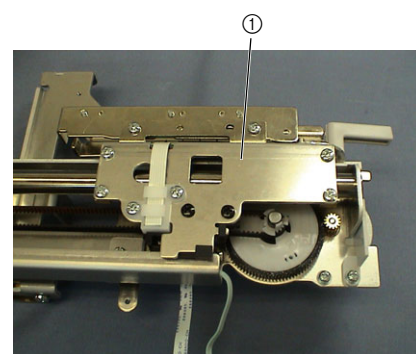



## 16 Cord clip attachment

1. Cord clip ① to be attached to the right: Hang the FFC cord ② (folded into N-shape) over the left guide ③ of the cord clip. Hold this section with the guide, and attach the cord clip ① to the hole ④ on the right side the XY carriage assembly.

**\*Key point**

- Insert the tab on the rear of the cord clip ① into the hole on the XY carriage assembly (larger hole), and then slide the cord clip ① to the left to secure it.
2. Cord clip ① to be attached to the left: Hold the FFC cord ② with the guide on the cord clip ①, and attach the cord clip ① to the hole ⑤ on the left side the XY carriage assembly.

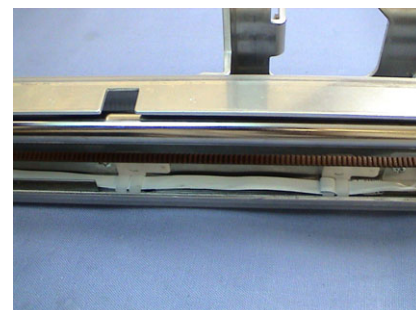
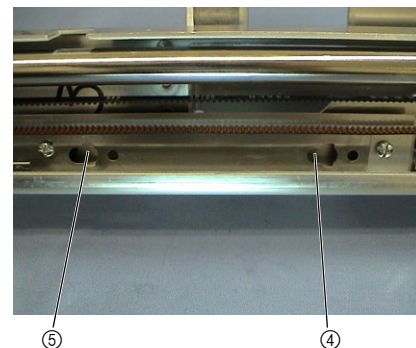
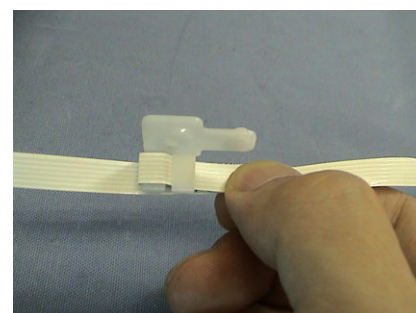
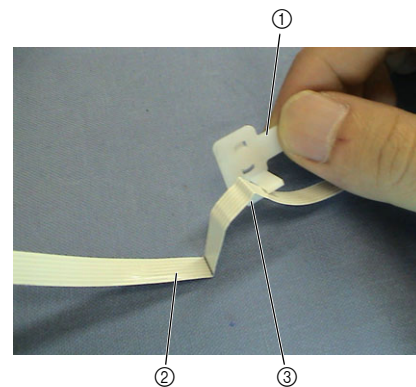

**17** YPM lead wire assembly attachment

1. Insert the YPM lead wire assembly ① into the connector of the Y pulse motor ②.

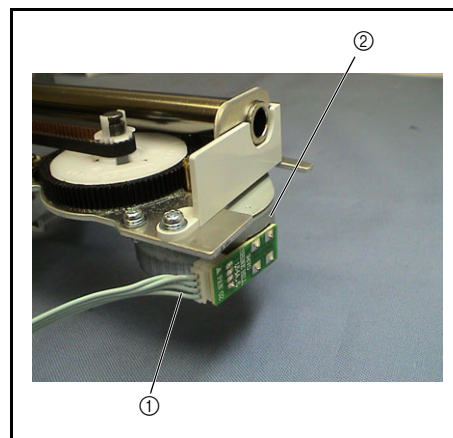

## 18 Cord grip attachment

1. Pass the FFC cord ① under the Y sensor PCB ②.
2. Bend the Y sensor PCB ② lead wire (3-wire cord) inward, and pass it under the Y sensor PCB ②.
3. Bundle the FFC cord ①, Y sensor PCB ② lead wire (3-wire cord), and YPM lead wire ③ (4-wire cord) in this order, and thread them through the cord grip ④.
4. Attach the cord grip ④ to the lower right of the X carriage assembly with the screw ①.

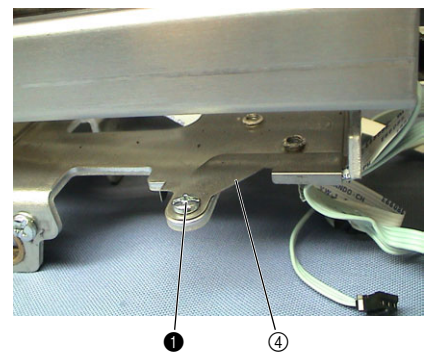
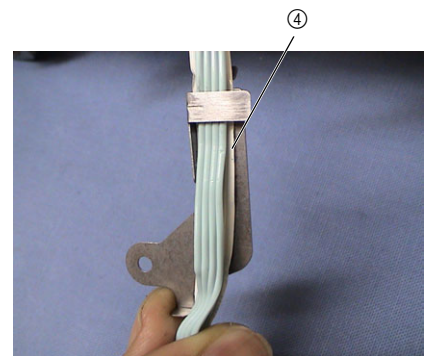
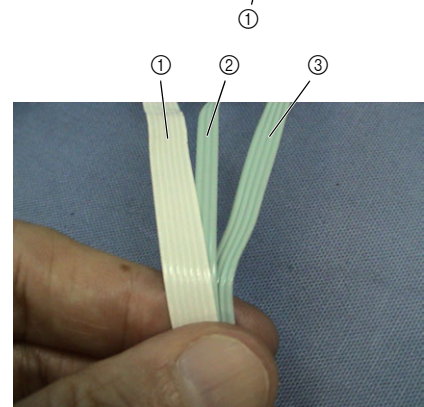
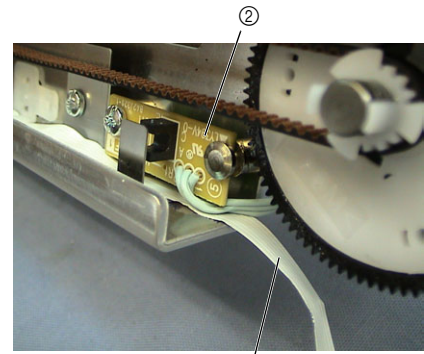

①		Screw, Bind M3X6	Torque 0.59 – 0.79 N·m
---	---	---------------------	---------------------------

## 19 X slider attachment

1. Insert the X guide shaft ① into the shaft hole on the XY carriage assembly ②.

### \*Key point

- Insert the end of the X guide shaft ① with the tab from the connector face of the Y pulse motor.

2. Pass the 3 cords from the cord grip ③ along the guide on the X slider ④.
3. Attach the X slider ④ to the X carriage assembly ⑤ with the 2 screws ①.

### \*Key point

- Tighten the screws ① in the following order: ①-1 (temporarily tighten), ①-2 (fully tighten), and ①-1 (fully tighten).
- Pull the FFC cord and Y sensor PCB lead wire (3-wire cord) to make them taut. Leave enough slack in the YPM lead wire (4-wire cord) so that it contacts the X carriage.

4. Place the lead wires over the FFC cord, with the Y sensor PCB lead wires on the left and the YPM lead wires on the right.
5. Pass the 3 cords through the lower guide and then the upper guide of the X slider ④.

### \*Key point

- Pull the 3 lead wires from the top of the X slider ④ to make them taut.

①		Screw, Pan (S/P washer) M4X8	Torque 0.19 – 0.39 N·m 1.18 – 1.57 N·m
---	--	---------------------------------	--

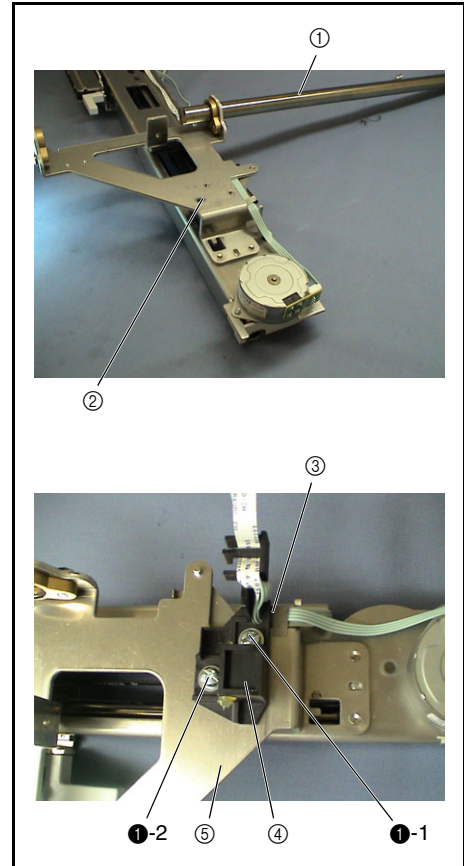

## 20 X guide shaft presser attachment

1. Insert the tab ② on the X guide shaft presser ① into the square hole ④ on the X guide shaft presser plate ③, and tighten the 2 screws ①.

### \*Key point

- Tighten the screws ① in the following order: ①-1 (temporarily tighten), ①-2 (fully tighten), and ①-1 (fully tighten).

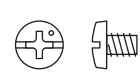
①		Screw, Bind M3X4	Torque 0.59 – 0.79 N·m
---	---	---------------------	---------------------------

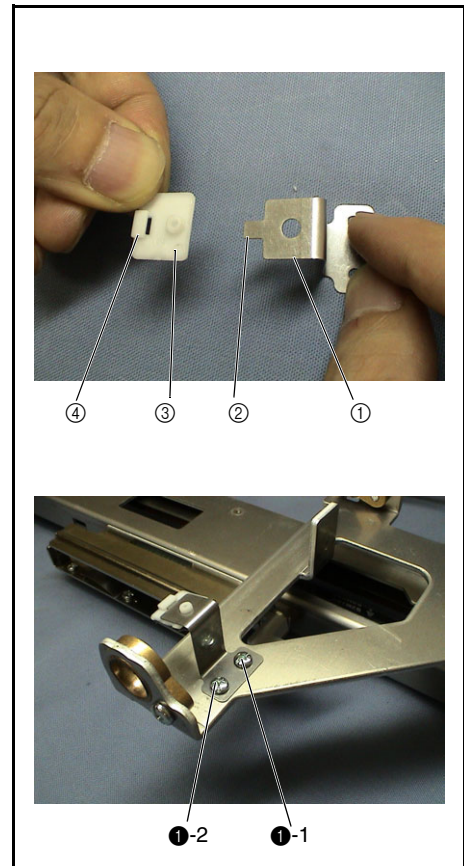

## 21 X driving gear pulley assembly attachment

1. Apply a bead of EPNOC AP (N)0 to the shaft of the main frame sub assembly.
2. Insert the driving gear pulley assembly ① into the shaft of the main frame sub assembly.

### \*Key point

- Position the driving gear pulley assembly ① with the pulley on the top.
- Insert the driving gear pulley assembly ① until the hook is caught in the groove on the shaft of the main frame sub assembly (a click can be heard).

Apply EPNOC AP (N)0 to the shaft of the main frame sub assembly.

Bead  
XC8387\*\*\*

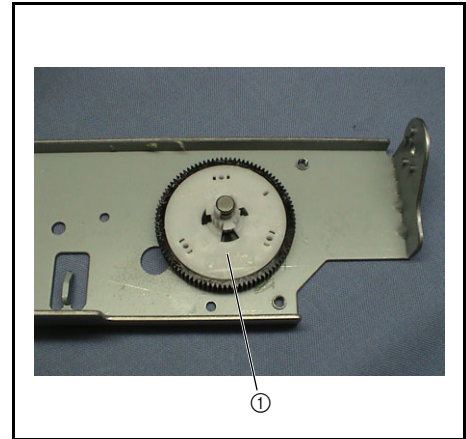

## 22 X tension pulley assembly attachment

1. Hang the timing belt (X belt) ① over the driving gear pulley assembly ②.
2. Hang the other end of the timing belt ① over the tension pulley assembly ③, and then attach the tension pulley assembly ③ to the left side of the main frame assembly with the 2 screws ④.

### \*Key point

- Move the tension pulley assembly ③ to the left to attach it.
- Tighten the screw ④ on the right lightly (0.19 - 0.39 Nm).
- Refer to "X-belt tension adjustment" on page 4 - 28 for the tension adjustment procedure.

④		Screw, Pan (SIP washer) M4X8	Torque 0.19 - 0.39 N·m 1.18 - 1.57 N·m
---	---	---------------------------------	--

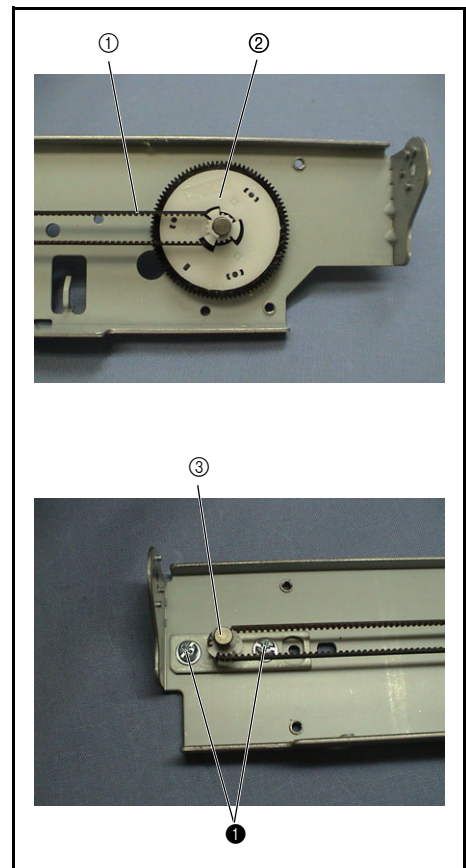



## 23 X pulse motor attachment

1. Attach the XPM lead wire assembly ① to the X pulse motor ②.
2. Apply 1 or 2 drops of FBK OIL RO 100 to the bushing ③ of the X pulse motor ②.
3. Attach the X pulse motor assembly to the main frame assembly with the 2 screws ①.

### \*Key point

- Insert the X pulse motor assembly from the bottom of the main frame assembly.
  - Bend the XPM lead wire assembly of the X pulse motor assembly toward you .
4. Apply a small bead of EPNOC AP (N)0 to 4 locations on the gear of the driving gear pulley assembly.

Apply FBK OIL RO 100 to the bushing of the X pulse motor.	1 - 2 drops XC8388***
Apply EPNOC AP (N)0 to 4 locations on the gear of the driving gear pulley assembly.	XC8387***

①		Screw, Pan (S/P washer) M3X7	Torque 0.79 – 1.18 N·m
---	--	---------------------------------	---------------------------

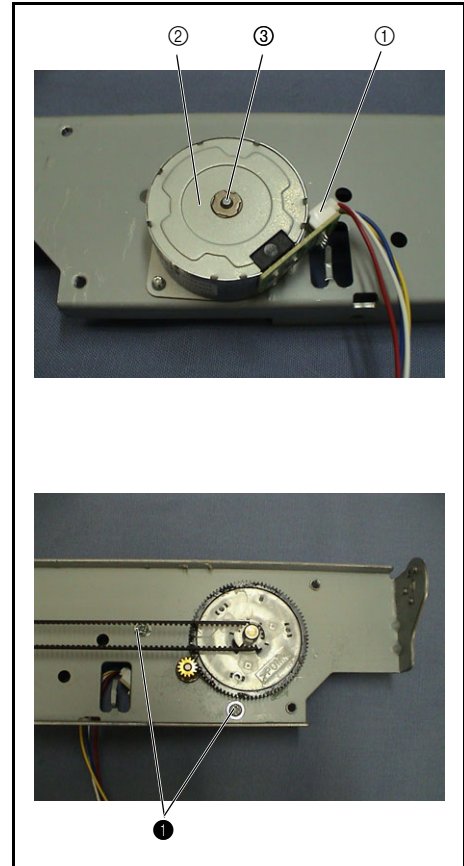

## 24 X guide plate attachment

1. Attach the X guide plate ① to the main frame, and temporarily tighten the 3 screws ①.  
Adjust the X-carriage height, and then fully tighten the 3 screws ①.

### \*Key point

- Refer to "X-carriage height adjustment" on page 4 - 30 for the adjustment procedure.
- Attach a coating clip.

①		Screw, Pan (S/P washer) M4X8	Torque 0.19 – 0.35 N·m 1.18 – 1.57 N·m
---	---	---------------------------------	--

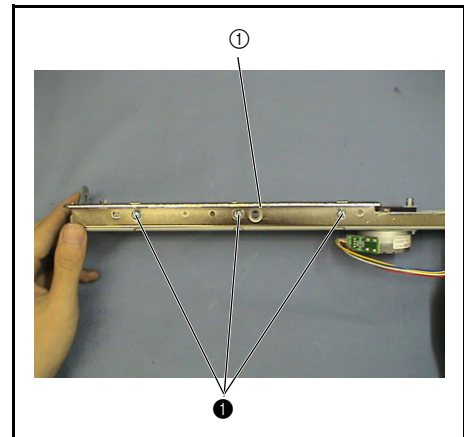

## 25 XY carriage unit attachment

1. Insert the X guide plate ② of the main frame assembly into the groove on the X slider ①.
2. Place the left end of the X guide shaft ③ over the left bushing ④ of the main frame assembly.
3. Position the tab on the right end of the X guide shaft ③ at an angle, and then insert the tab downward at an angle relative to the right bushing ⑤.
4. Hold both ends of the X guide shaft ③, and then rotate the shaft away from the operator to secure it.
5. Tighten the screws ① at both ends of the X guide shaft ③.

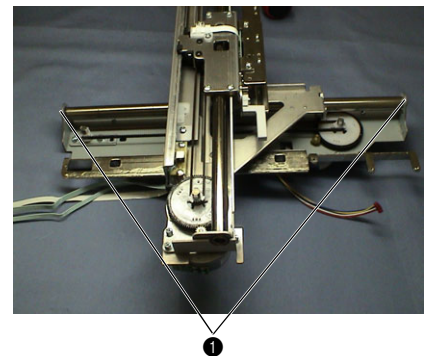
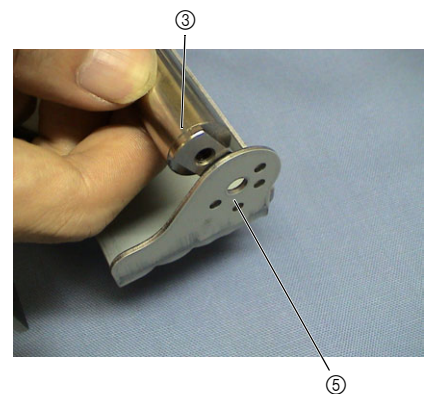
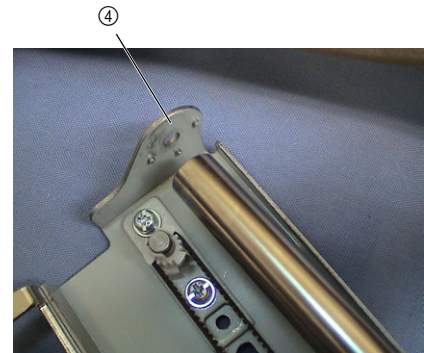
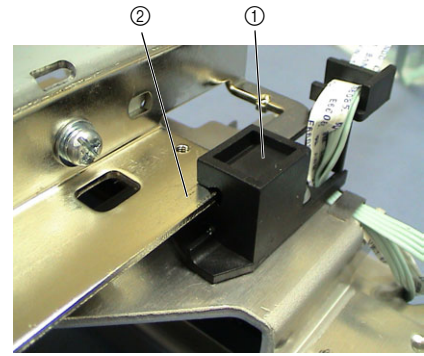

①		Screw, Pan (SiP washer) M4X8	Torque 1.18 – 1.57 N·m
---	---	---------------------------------	---------------------------

## 26 X belt presser attachment

1. Attach the X belt presser ① to the X carriage assembly, and then temporarily tighten the screw ❶.

### \*Key point

- Hold the X belt with the X belt presser, and align the ridge with the trough.
2. Slide the XY carriage assembly left and right to check that the belt is secured to the X belt presser, and then fully tighten the screw ❶.

❶		Screw, Pan (SIP washer) M4x8	Torque 1.18 – 1.57 N·m
---	---	---------------------------------	---------------------------

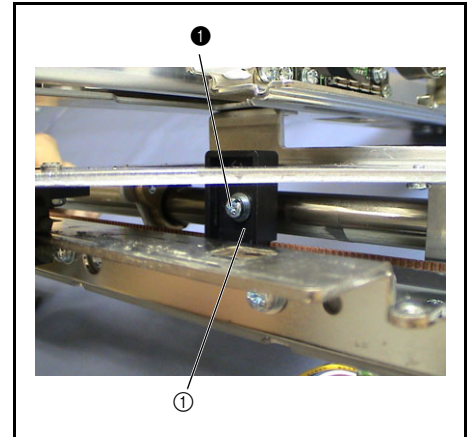

## 27 X sensor PCB assembly attachment

1. Slide the X carriage assembly of the main frame assembly to the right as far as possible.
2. Attach the X sensor PCB assembly ① to the X guide plate ② with the screw ❶.

### \*Key point

- Engage the positioning tab at the left end of the X guide plate ② with the positioning notch on the X sensor PCB assembly ①.

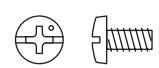
❶		Screw, Bind M3x6	Torque 0.59 – 0.79 N·m
---	---	---------------------	---------------------------

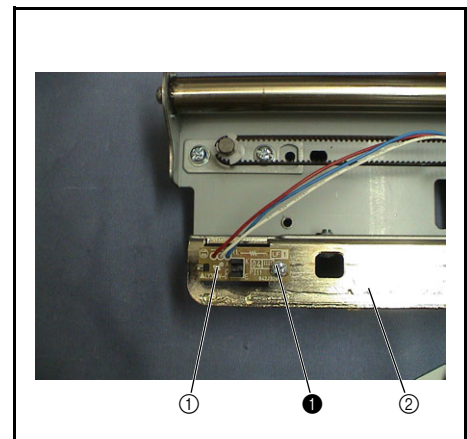

## 28 X sensor PCB assembly cord arrangement

1. Slide the X carriage assembly ① of the main frame assembly to the right as far as possible.
2. Hang the lead wire of the X sensor PCB assembly ② over the left hook ③ on the bottom of the main frame, and then tie it with a band.
3. Slide the X carriage assembly ① of the main frame assembly to the left as far as possible
4. Hang the lead wire of the X sensor PCB assembly ② over the right hook ④ on the bottom of the main frame.

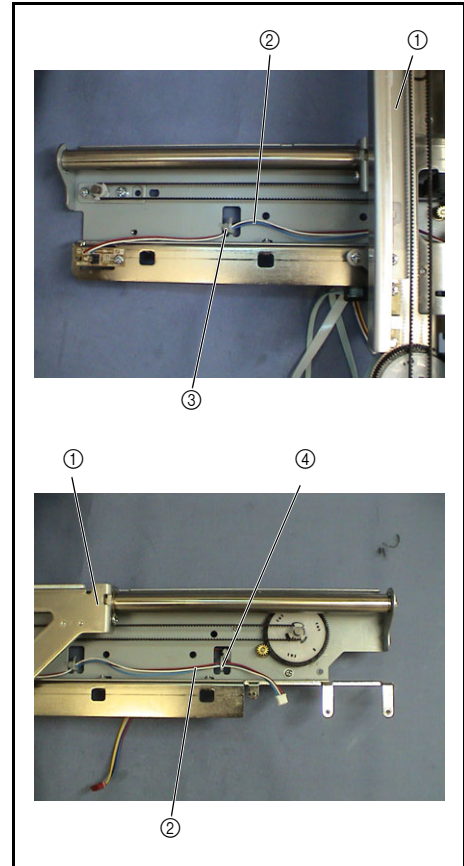

## 29 E cord supporter attachment

1. Attach the E cord support ① to the X guide plate with the screw ①.

### \*Key point

- Attach the screw ① to the hole at the left side of the screw ②.

①		Screw, Pan (SIP washer) M4X8	Torque 0.79 – 0.98 N·m
---	---	---------------------------------	---------------------------

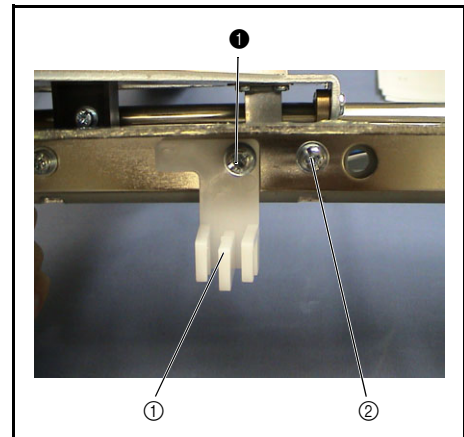

### 30 E cord supporter cord arrangement

1. Slide the X carriage assembly ① to the left as far as possible.
2. Arrange the YPM lead wires ② (4-wire cord) on the front side and the Y sensor PCB lead wire ③ (3-wire cord) on the rear side so that they are parallel, and then place the FFC cord ④ over them.
3. Thread the 3 cords through the E cord support ⑤, and then pull them to the right so they are taut.

**\*Key point**

- Bend the 3 cords to thread them through the E cord supporter guide.

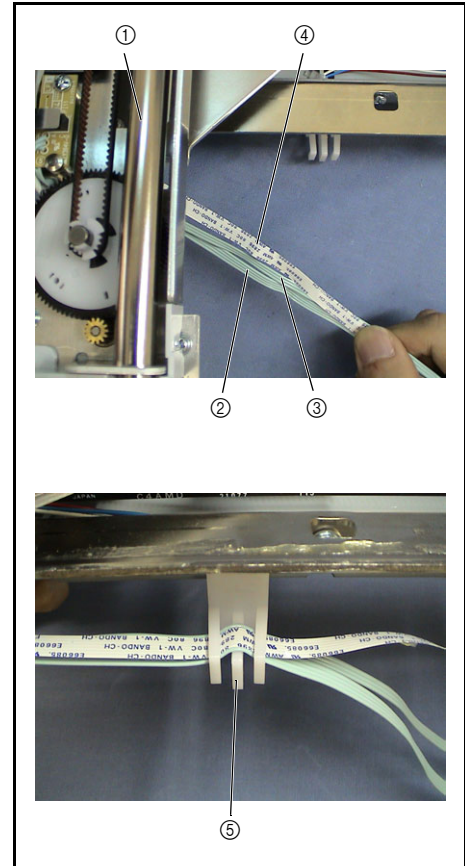

### 31 EMB relay PCB assembly attachment

1. Connect the X sensor PCB assembly connector ①, Y sensor PCB assembly connector ②, FFC cord connector ③, XPM connector ④, and YPM connector ⑤ to the EMB relay PCB assembly ⑥.
2. Attach the EMB relay PCB assembly ⑥ to the X guide plate with the 3 screws ①.

**\*Key point**

- Tighten the screws ① in the following order: ①-1 (temporarily tighten), ①-2 (fully tighten), ①-3 (fully tighten), and ①-1 (fully tighten).

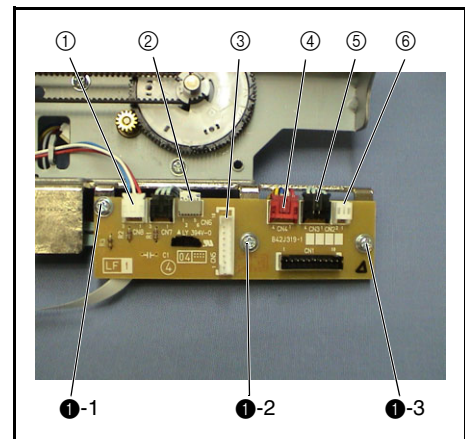

<b>1</b>		Screw, Pan (SIP washer) M3X7	Torque 0.49 – 0.69 N·m
----------	--	---------------------------------	---------------------------



**32** Drop trigger attachment

1. Attach the drop trigger ①.

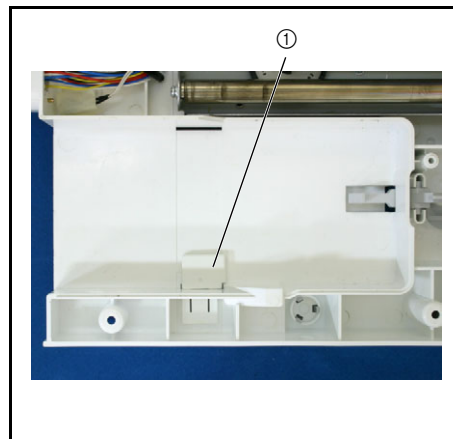
**33** Lock release lever ASSY assembly

1. Attach the lock finger ① to the lock release lever ②.

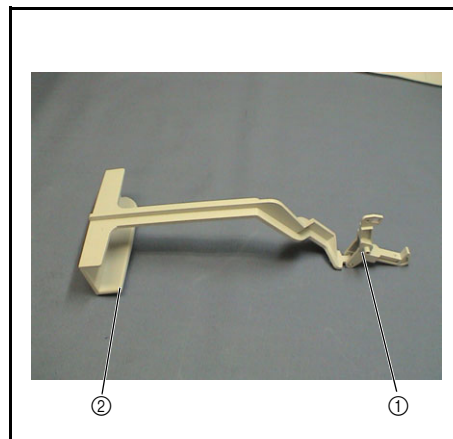

### 34 Lock release lever assembly attachment

1. Hook one end of the spring **S64** onto the spring hole ② on the ES base cover ①.
2. Insert the lock finger ④ and the lock release lever ⑤ of the lock release lever assembly ③ into the corresponding holes on the EX base cover ①.
3. Hook the other end of the spring **S64** onto the hole on the lock finger ④.

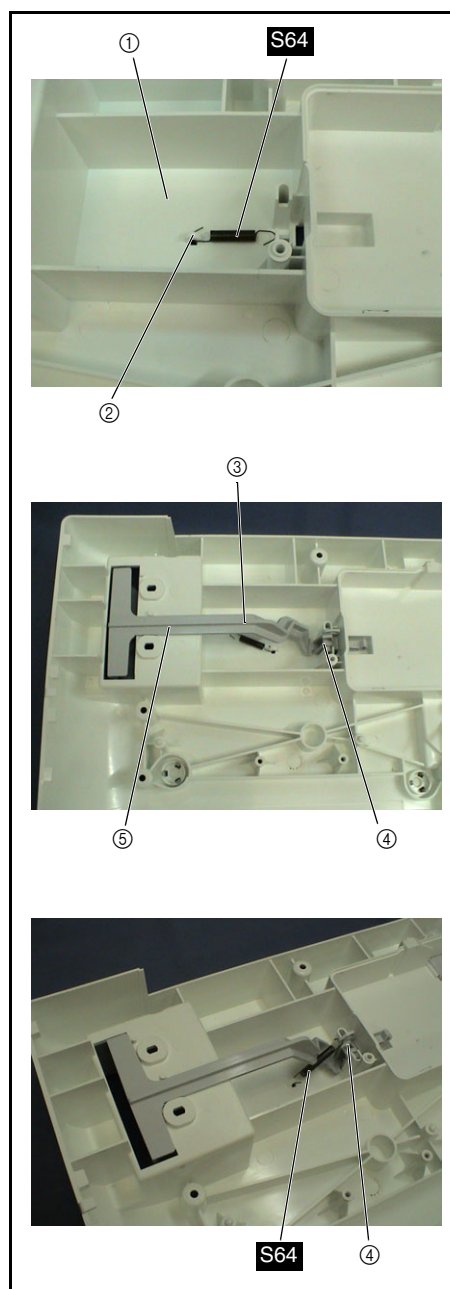

S64



SPRING  
XC8096\*\*\*

### 35 ES base cover assembly attachment

1. Attach the ES base cover assembly ① to the main frame assembly ② with the 2 screws ①.

**\*Key point**

- Set the ES base cover assembly ① first, and then attach the main frame assembly ② to it.
- Engage the 2 positioning tabs on the EX base cover assembly ① with the corresponding positioning holes on the main frame assembly ②.
- Pass the FFC cord, Y sensor PCB assembly lead wire, and YPM lead wire under the main frame assembly.

①		Taplite, Cup B M4X14	Torque 0.79 – 1.18 N·m
---	---	-------------------------	---------------------------

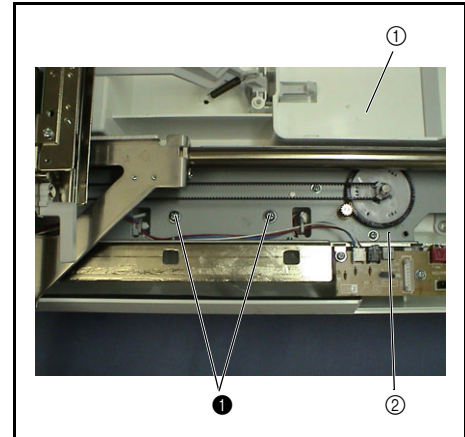

### 36 EMB unit lead wire assembly attachment

1. Attach the EMB unit lead wire assembly ① to the ES base cover ② with the 2 screws ①.

**\*Key point**

- Insert the black connector of the EMB unit lead wire assembly ① into the square hole on the ES base cover from the outside.

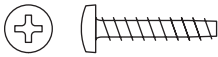
①		Taplite, Bind P M3X16	Torque 0.59 – 0.79 N·m
---	---	--------------------------	---------------------------

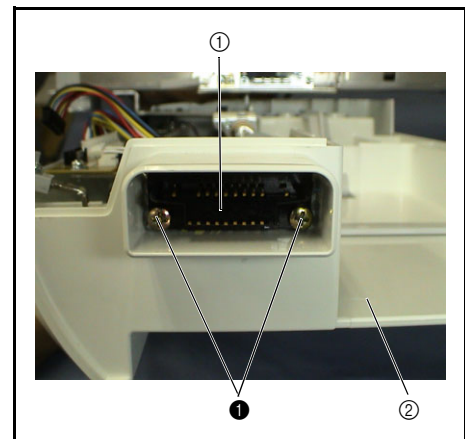

### 37 EMB relay PCB assembly attachment

1. Insert the lead wire connector ① of the drop switch assembly into the EMB relay PCB assembly ②.
2. Insert the lead wire connector (white) ③ of the EMB unit lead wire assembly into the EMB relay PCB assembly ②.
3. Wind the lead wire connector (black) ④ of the EMB unit lead wire assembly over the lead wire connector (white) ③ one turn, and then insert it into the EMB relay PCB assembly ②.
4. Tie the 3 lead wires with a band, and attach the coating clip ⑤.

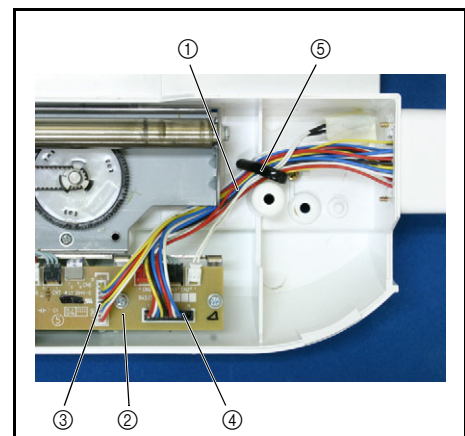

### 38 ES main cover assembly attachment

1. Position the embroidery unit assembly with the main unit attachment section on the right, and then slide the X carriage assembly ② to the left as far as possible.
2. Attach the ES main cover assembly ③ to the ES base cover assembly ① with the 10 screws (①x5 and ②x5).

#### \*Key point

- Push the X carriage assembly ② to the felt of the ES main cover assembly ③, and then slide the ES main cover assembly ③ to the left.
- Slide the X carriage assembly ② to the center, and then tighten the 10 screws (①x5 and ②x5) to the bottom of the ES base cover assembly ①.
- Tighten the screws ① in the following order: ①-1, ①-2, ①-3, ①-4, and ①-5.  
Tighten the screws ② in the following order: ②-1, ②-2, ②-3, ②-4, and ②-5.

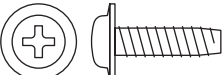
①		Screw, Pan (S/P washer) M4X8	Torque 0.79 – 1.18 N·m
②		Taprite, Cup B M4X14	Torque 0.79 – 1.18 N·m

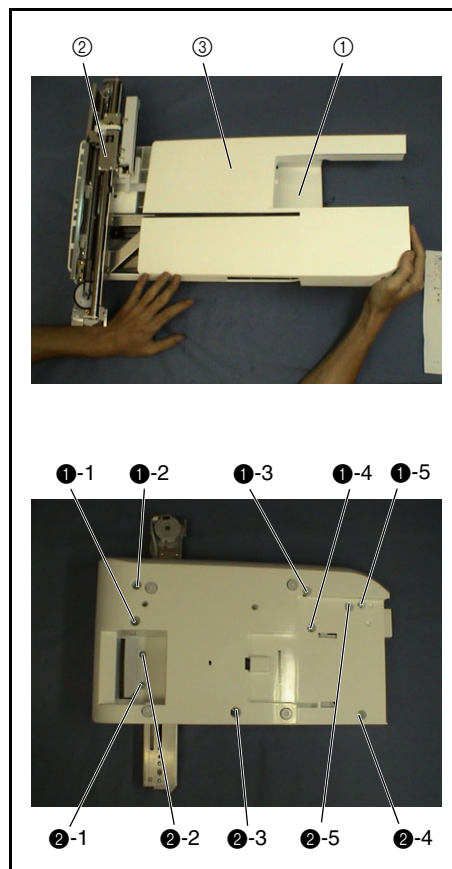

### 39 E hoop stay cover attachment

1. Position the embroidery unit assembly with the main unit attachment section on the left.
2. Attach the E hoop stay cover ① to the Y carriage assembly with the screws (① and ②).

#### \*Key point

- Engage the positioning tab on the E hoop stay cover ① with the positioning hole on the Y carriage assembly.
- Slide the E hoop stay cover ① to the right.
- Tighten the screws ①② in the following order: ① (temporarily tighten), ② (fully tighten), and ① (fully tighten).

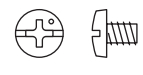
①		Screw, Pan (S/P washer) M3X7	Torque 0.59 – 0.79 N·m
②		Screw, Bind M3X4	Torque 0.59 – 0.79 N·m

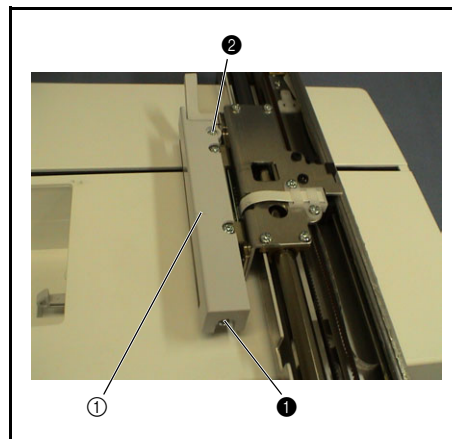



## 40 X carriage cover attachment

1. Position the embroidery unit assembly with the main unit attachment section ① on the left.
2. Attach the X carriage cover ② to the X carriage assembly ③ with the screw ④.

### \*Key point

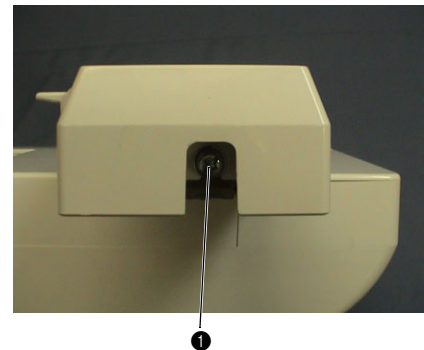
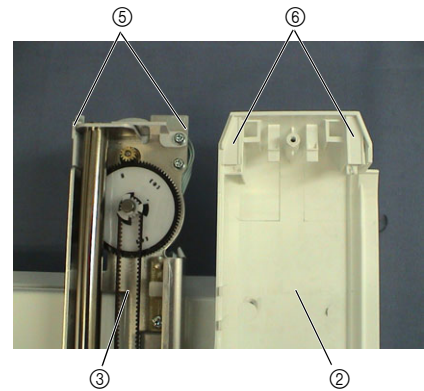
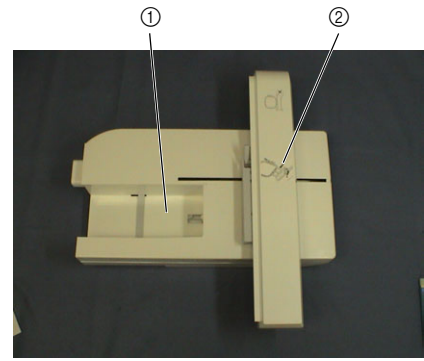
- Insert the 2 tabs ⑤ on the X carriage assembly ③ into the corresponding grooves ⑥ inside the X carriage cover ②.
- Press the indicated section of the X carriage cover ② from the top, and then tighten the screw ④.



④		Screw, Pan (S/P washer) M4X8	Torque 0.79 – 1.18 N·m
---	---	---------------------------------	---------------------------





## 41 YPM cover attachment

1. Position the embroidery unit assembly with the main unit attachment section ① on the right.
2. Attach the YPM cover ② to the indicated section ④ of the X carriage cover ③ with the screw ①.

### \*Key point

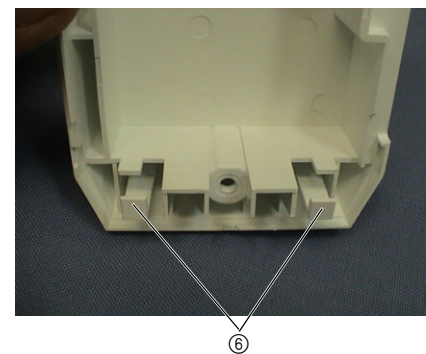
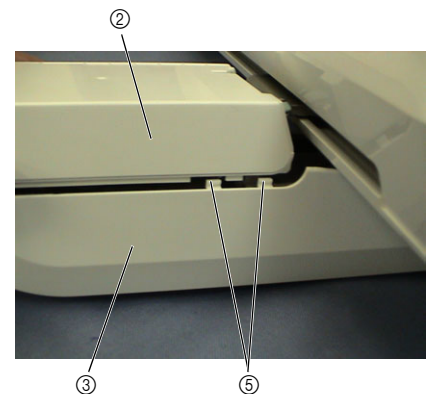
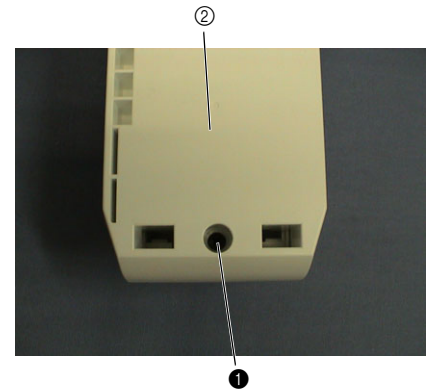
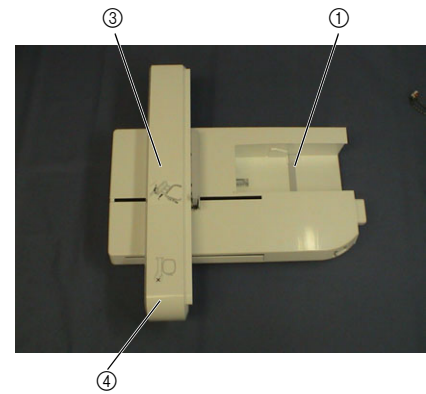
- Hang the hooks ⑤ on the side face of the X carriage cover ③ over the YPM cover ②.
- Hang the 2 hooks ⑥ inside the YPM cover ② over the X carriage cover ③.
- Press the YPM cover ② until you hear a click.
- Tighten the screw ① from the bottom of the YPM cover ②.



①		Taptite, Bind P M3X10	Torque 0.59 – 0.78 N·m
---	---	--------------------------	---------------------------

# 4 Adjustment

---

Touch panel adjustment.....	4 - 2
Timing belt tension adjustment .....	4 - 3
Motor belt tension adjustment.....	4 - 4
Upper shaft rotation shutter angle adjustment... ..	4 - 5
Three point needle drop adjustment .....	4 - 6
Needle clearance left/right adjustment....	4 - 7
Needle bar rising adjustment .....	4 - 8
Needle bar height adjustment .....	4 - 9
Needle threader adjustment.....	4 - 10
Clearance between needle and rotary hook point adjustment	4 - 11
Presser bar height and parallelism adjustment	4 - 12
Needle and presser front/back position adjustment	4 - 13
Fine tension adjustment.....	4 - 14
Upper thread tension adjustment.....	4 - 15
Thread guide shutter clearance adjustment	4 - 16
Inner rotary hook tension adjustment....	4 - 17
Inner rotary hook bracket position adjustment.	4 - 18
Cloth pressure setting adjustment .....	4 - 19
Feed dog height and squareness adjustment .	4 - 20
Front/back and left/right position of feed dog adjustment	4 - 21
Feed forward/backward adjustment.....	4 - 22
Side feed straight stitch adjustment .....	4 - 23
One point adjustment.....	4 - 24
Bobbin winder adjustment.....	4 - 25
Knee lifter position adjustment.....	4 - 26
BH lever switch position adjustment .....	4 - 27
X-belt tension adjustment .....	4 - 28
Y-belt tension adjustment .....	4 - 29
X-carriage height adjustment .....	4 - 30

1. Turn the power on while holding down the [Start/Stop], [Reverse stitch], and [Needle position] buttons.
2. Touch the positions marked with crosses (+) on the touch panel in order from 1 to 5.

**NOTE**

- Setting is successful if a single beep sounds when "5" is pressed.
  - An error has occurred if two beeps sound when "5" is pressed. Repeat from position 1 again.
3. Turn the power off and then on again. Check that the screen display matches the positions on the touch panel.

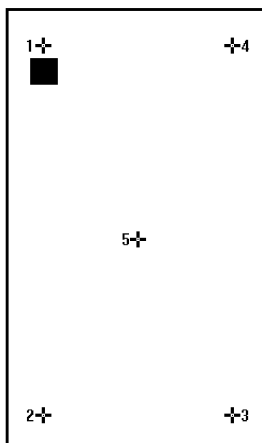

1. Loosen the pan head screw (S/P washer, M4X10) securing the tension pulley assembly.
2. Adjust the position of the tension pulley so that the belt deflects 2.95 to 3.05 mm when a force of 1.96N (200g) is applied to the center of the belt.
3. Tighten the pan head screw (S/P washer, M4X10) to secure the tension pulley assembly.

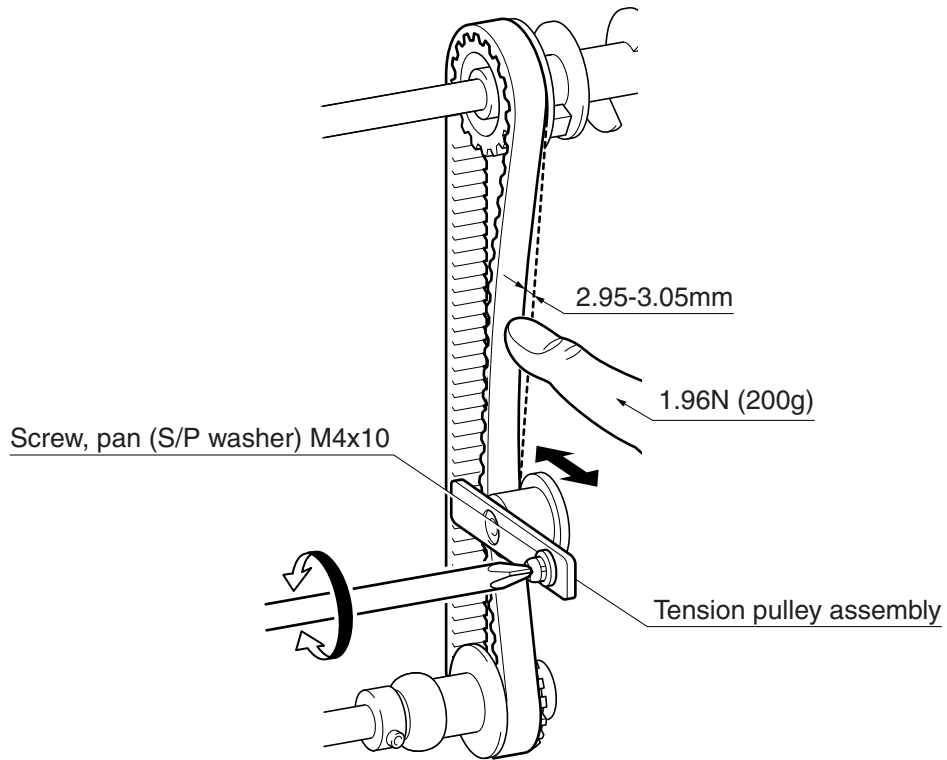

1. Loosen the Upset M4X12DB securing the motor holder.
2. Adjust the position of the motor holder so that the belt deflects 1.5 to 3.5 mm when a force of 0.98N (100g) is applied to the center of the belt.
3. Tighten the Upset M4X12DB to secure the motor holder.

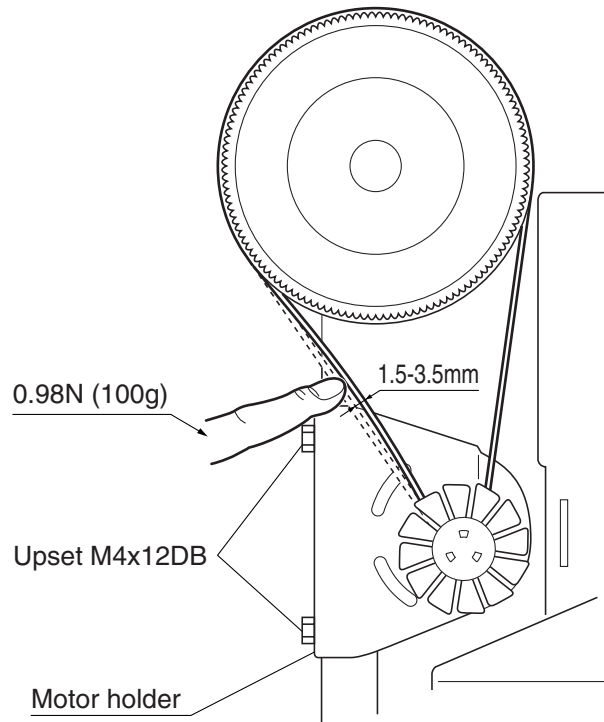



1. Start the test mode.
2. Select test mode "22". (NP sensor mode)
3. Turn the pulley to raise the needle bar to the limit.
4. Loosen the screws securing the upper shaft rotation shutter.
5. Turn the pulley to lower the needle bar  $1.3\text{mm} \pm 0.1\text{mm}$
6. Rotate the upper shaft rotation shutter in the shaft rotation direction, and secure the rotation shutter at the position the buzzer stops (position the shutter at the far right enters the sensor).

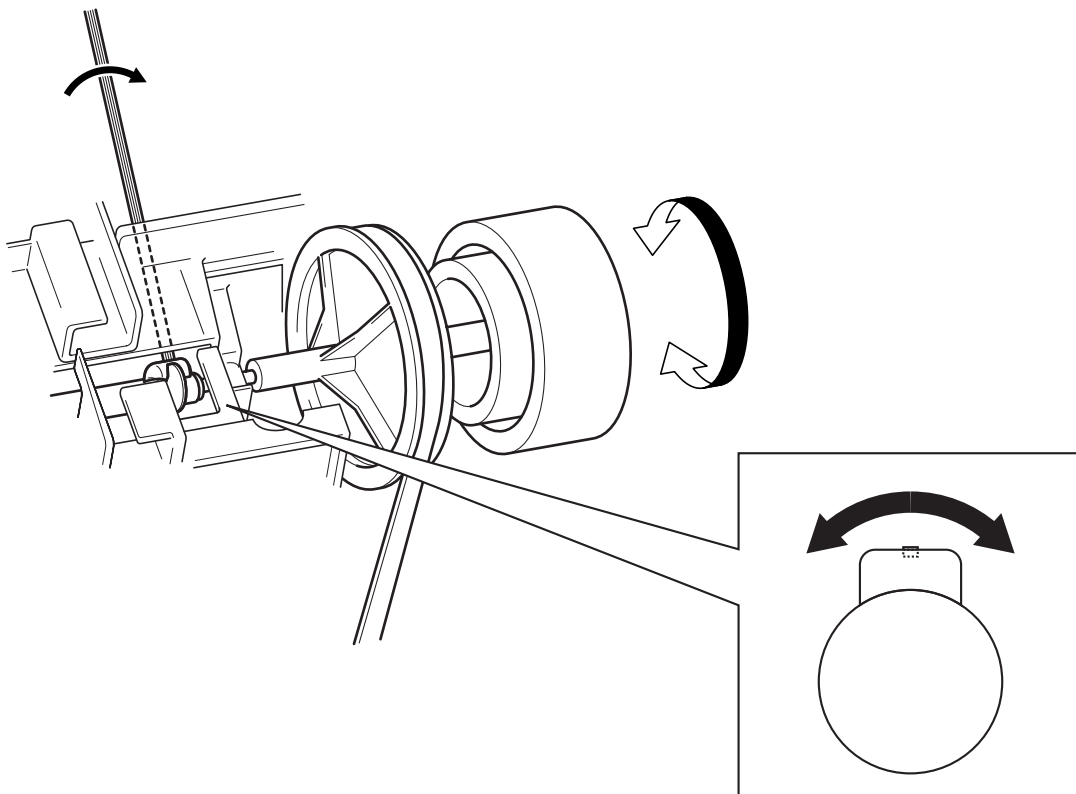
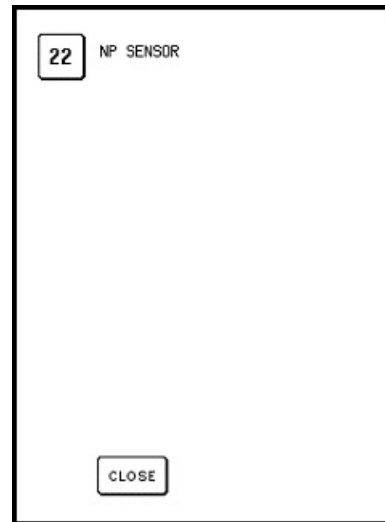
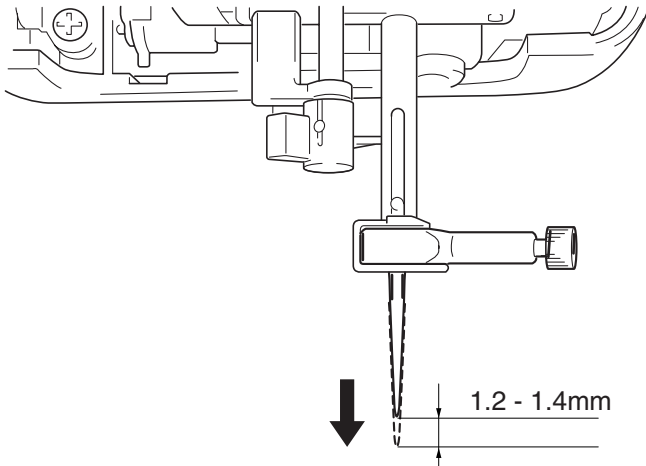

1. Remove the front cover, and turn the power on while pressing [SW3] and [SW4] on the main PCB assembly.
2. Press [SW4] (select test mode "4" when the front cover is attached).
3. Turn the pulley by hand until the tip of the needle enters the needle hole.
4. Loosen the socket bolt (M3X10) of the zigzag adjusting nut.
5. Adjust the zigzag adjusting nut so that the needle drop is centered over the needle hole on needle plate A at the left base line, center base line, and right base line.
6. Tighten the socket bolt (M3X10).

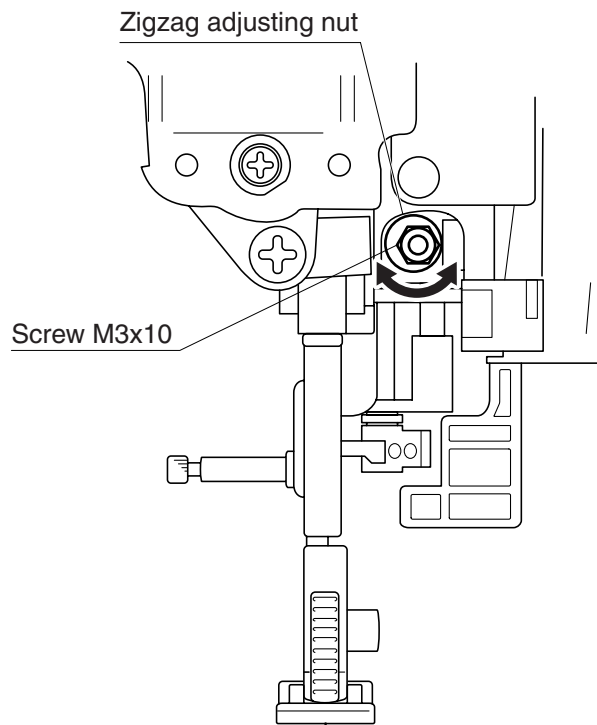
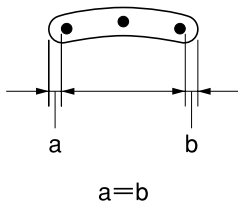

1. Turn the pulley by hand until the tip of the needle enters the needle hole.
2. Loosen the screw (3X10).
3. Move the needle holder shaft block to the left or right so that the needle drop is centered over the needle hole on needle plate A at the left base line and right base line.
4. Tighten the screw (3X10).

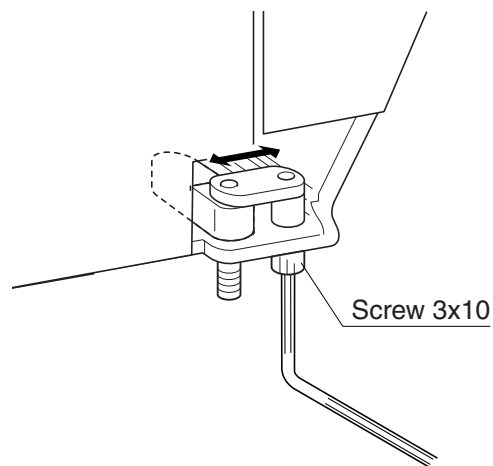
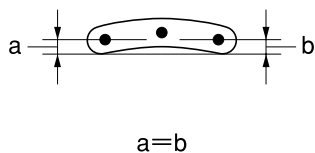

1. Remove the front cover, and turn the power on while pressing [SW3] and [SW4] on the main PCB assembly.
2. Press [SW4] four times (select test mode "4" and then " ← " when the front cover is attached) to move the needle bar to the left base line.
3. Turn the power off.
4. Remove the 2 flat screws (M4), and then remove needle plate A from the feed base.
5. Turn the pulley by hand to lower the needle bar to the limit.
6. Loosen the 3 socket set screws (FT, M5X5) securing the lower shaft pulley D.
7. Move the lower shaft pulley D and the lower shaft A assembly so that the right edge of the needle is aligned with the tip of the outer rotary hook when the needle bar is raised 2.9 to 3.3 mm from the reference line of the lowest point. (Set a ruler on the left side and measure the distance.)
8. Tighten the 3 socket set screws (FT, M5X5) to secure the lower shaft pulley D.

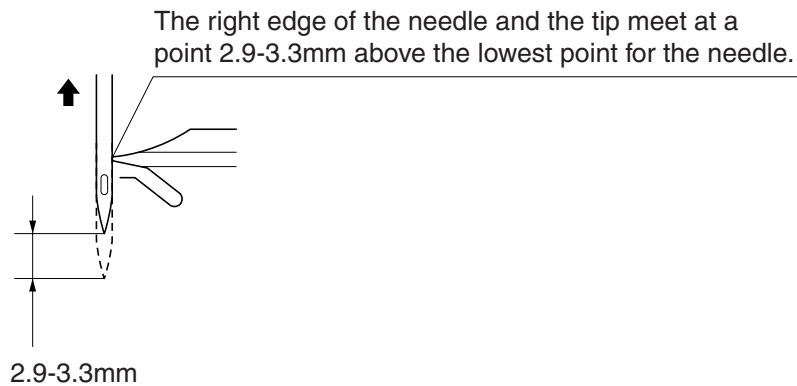
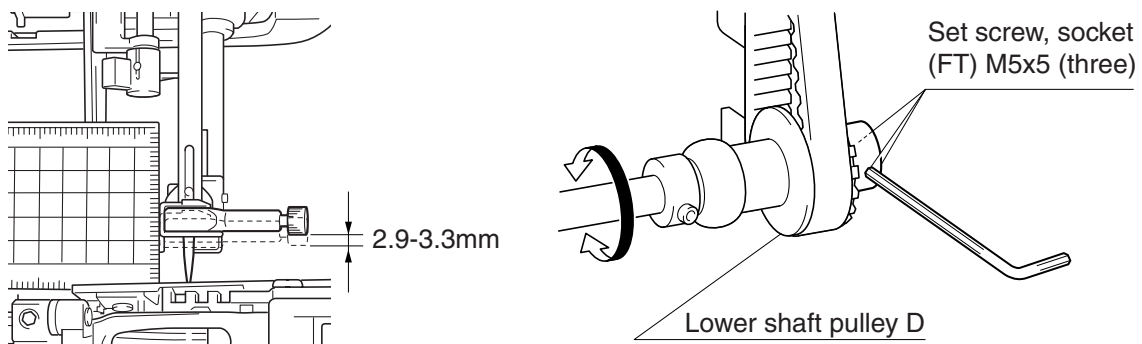

1. Remove the front cover, and turn the power on while pressing [SW3] and [SW4] on the main PCB assembly.
2. Press [SW4] four times (select test mode "4" and then " ← " when the front cover is attached) to move the needle bar to the left base line.
3. Turn the power off.
4. Remove the 2 flat screws (M4), and then remove needle plate A from the feed base.
5. Turn the pulley by hand until the right edge of the needle is aligned with the tip of the outer rotary hook.
6. Loosen the socket set screw (CP, M4X4) securing the needle bar block.
7. Adjust the height of the needle bar so that the clearance between the top of the needle hole and the lower edge of the outer rotary hook tip is 1.0 to 1.4 mm.

**NOTE**

- Make sure the needle block is straight.
8. Tighten the socket set screw (CP, M4X4) to secure the needle bar block.
  9. Attach needle plate A to the feed base with 2 flat screw (M4).

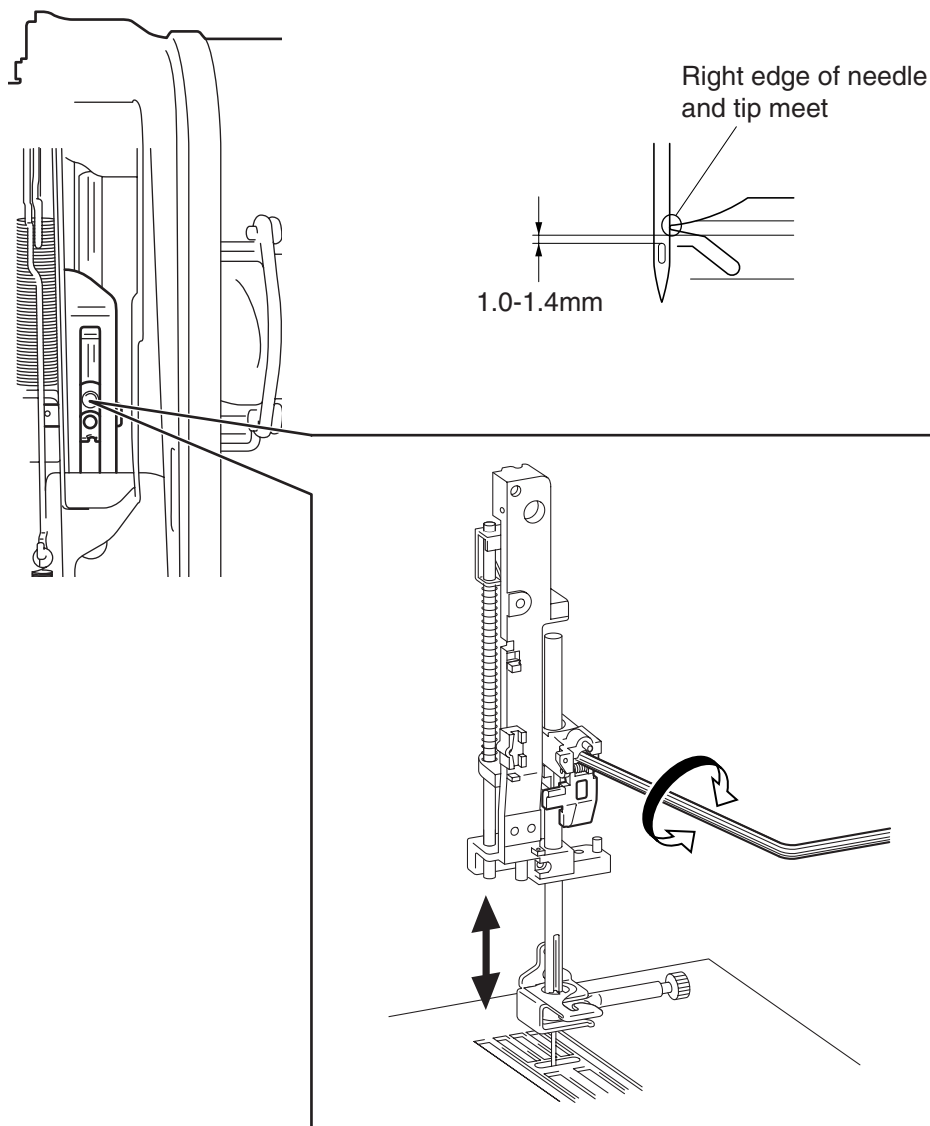

1. Attach a needle.
2. Turn the pulley to raise the needle bar to the limit.
3. Loosen the socket set screw (FT, M4X4) securing the needle thread block.
4. Adjust the height of the needle thread block so that the threading hook passes through the needle hole, and secure the needle thread block with the socket set screw (FT, M4X4).

**\*Key point**

- Secure the socket set screw (FT, M4X4) at a position slightly to the left when viewed from the front of the machine.
- Adjust the height so that the upper edge of the threading hook is level with the upper edge of the needle hole.

**NOTE**

- If the position of the needle thread block socket set screw is too far to the left, the hook will not operate and treading is not possible.
- If the position of the needle thread block socket set screw is too far to the right, the needle thread block will contact the needle bar supporter assembly, resulting in damage.

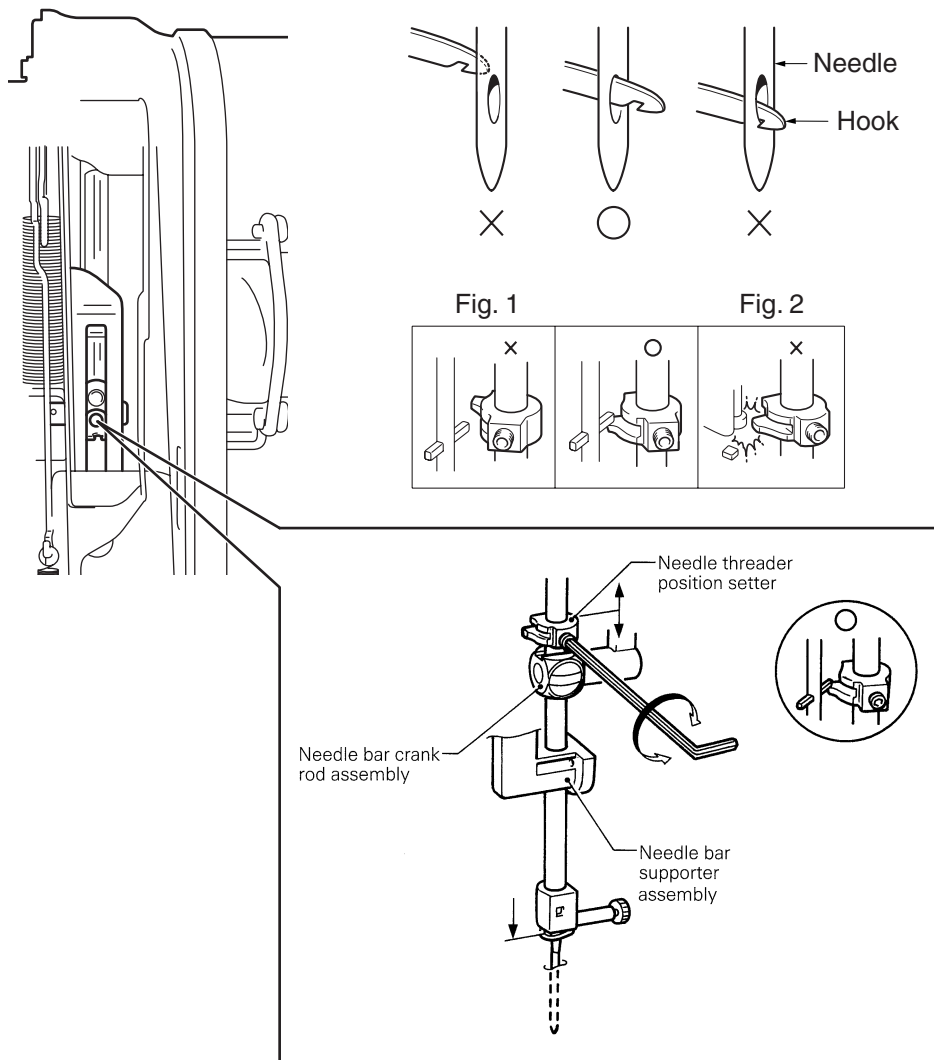



1. Remove the front cover, and turn the power on while pressing [SW3] and [SW4] on the main PCB assembly.
2. Press [SW4] four times (select test mode "4" and then " ← " when the front cover is attached) to move the needle bar to the left base line.
3. Turn the power off.
4. Remove the 2 flat screws (M4), and then remove needle plate A from the feed base.
5. Loosen the screw (M3X20).
6. Turn the pulley by hand until the right edge of the needle is aligned with the tip of the outer rotary hook.
7. Adjust the clearance between the needle and the outer rotary hook (front and back) to 0.1 mm or less using the adjusting screw.
8. Tighten the screw (M3X20) to secure the adjusting screw.

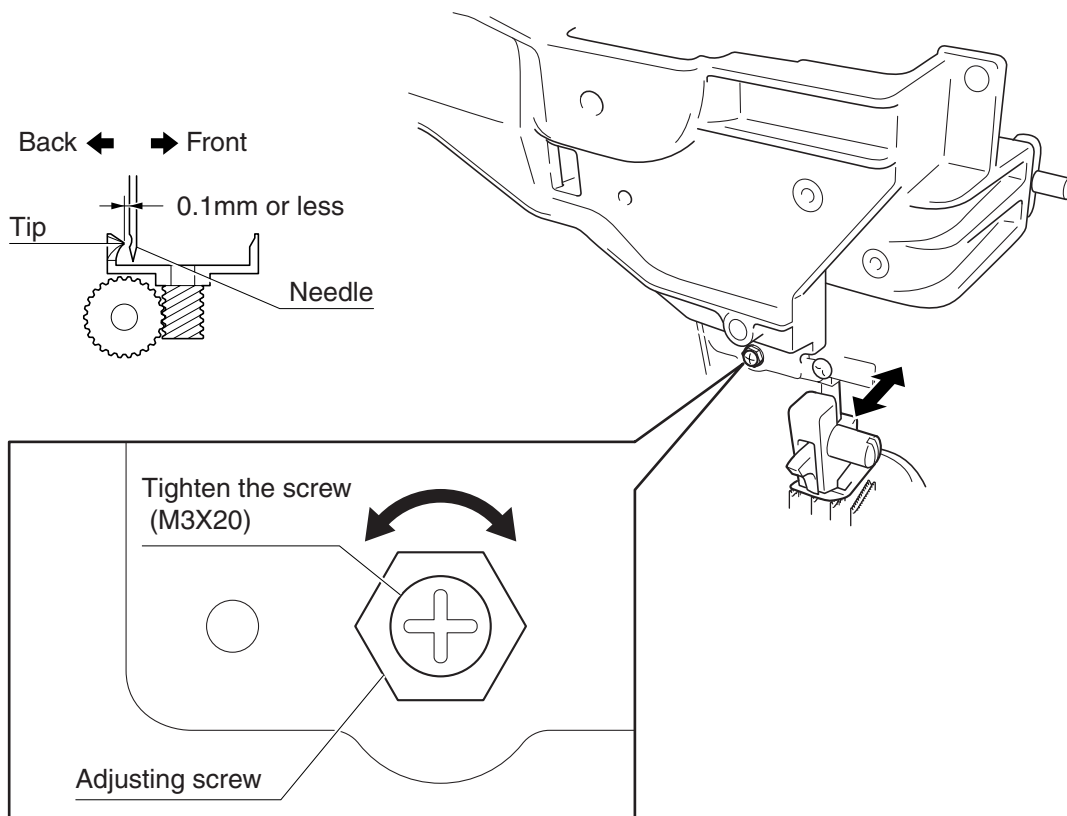

1. Attach J presser foot.
2. Raise the presser foot lifter.
3. Turn the pulley by hand until the feed dog is lower than needle plate A.
4. Loosen the set screw (CP, M5X10) securing the presser bar clamp assembly.
5. Adjust the height of the presser bar so that the clearance between the top of needle plate A and the bottom of the presser is 7.0 - 7.5 mm.
6. Tighten the set screw (CP, M5X10) to secure the presser bar clamp assembly.

**NOTE**

- Use the J presser foot.
- Adjust the presser bar so that the needle plate feed dog hole is parallel to the presser.

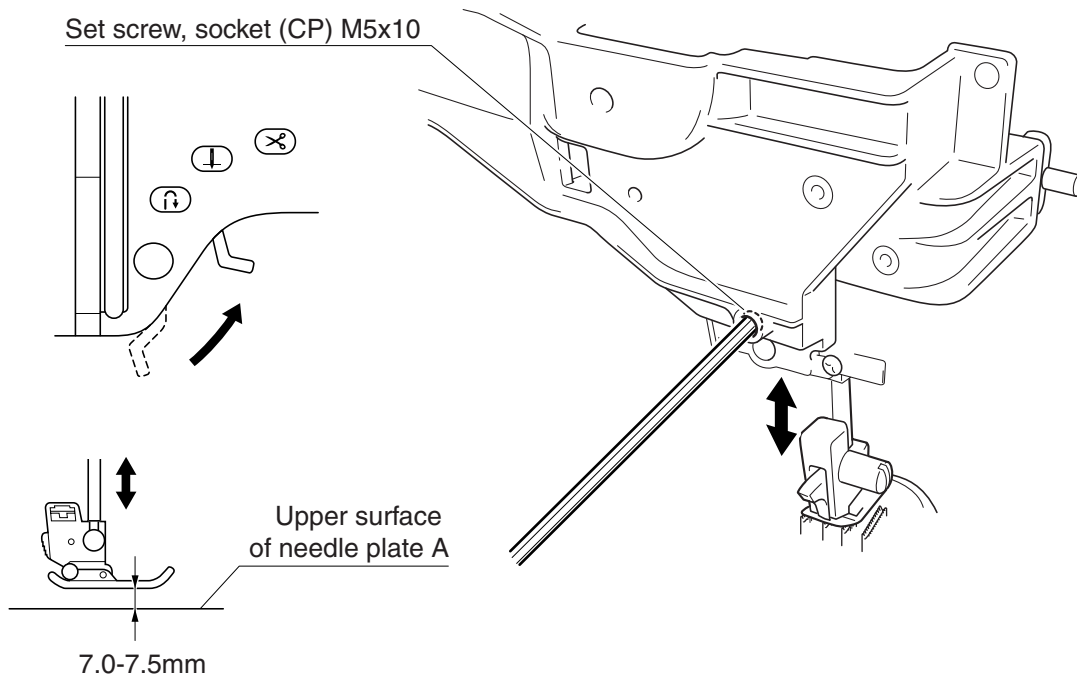

1. Attach J presser foot.
2. Turn the pulley by hand until the tip of the needle enters the needle hole.
3. Loosen the lock nut.
4. Move the needle tip to the center position (front/back) of the needle hole using the socket set screw (CP, M4X12).
5. Tighten the lock nut.

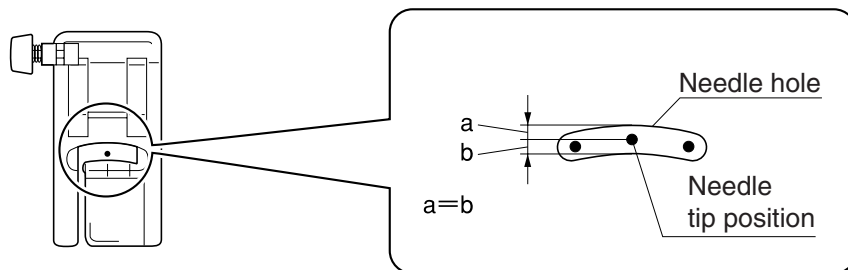
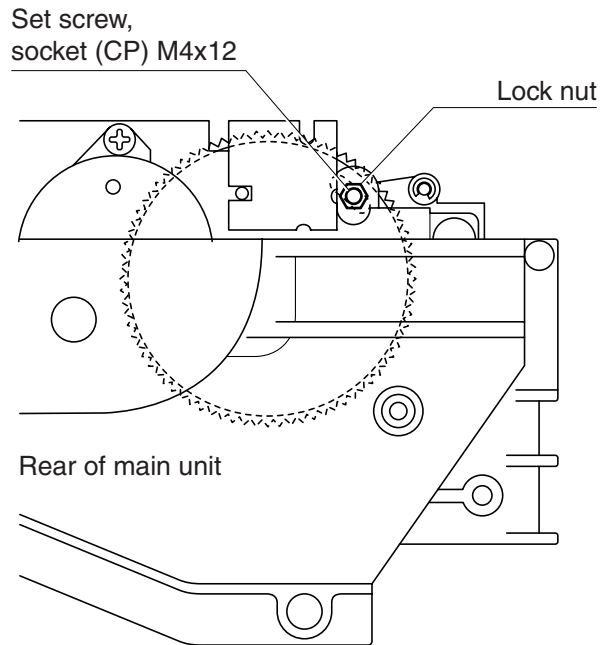

1. Raise the presser foot lifter.
2. Pass the Schappe Spun Sewing Thread #60 through the thread guide and then the tension plate.
3. Lower the presser foot lifter.
4. Pull the thread with a tension gauge, and adjust the tension to 0.08 to 0.11N (8 to 11g) using the power lock (2x3).

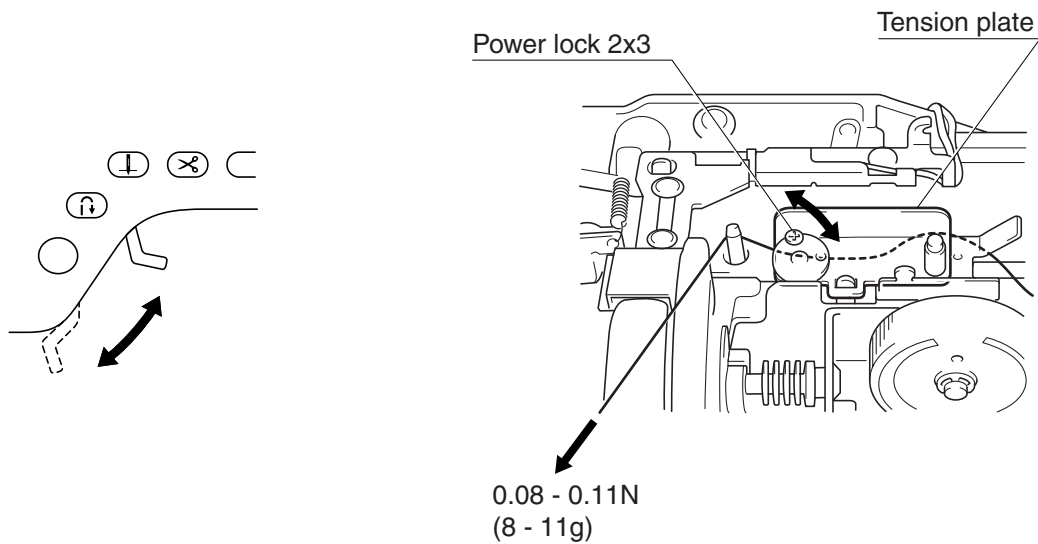

1. Raise the presser foot lifter.
2. Turn the power on, and check that the AT pulse motor returns to its home position.
3. Turn the power off.
4. Pass the Schappe Spun Sewing Thread #60 through the thread guide, tension plate, tension disk, and brake plate assembly in this order.
5. Lower the presser foot lifter.
6. Pull the thread with a tension gauge, and adjust the tension to 0.51 to 0.62N (52 to 63g) using the thread tension adjusting screw.
7. Apply a small amount of screw lock agent to the thread tension adjusting screw.

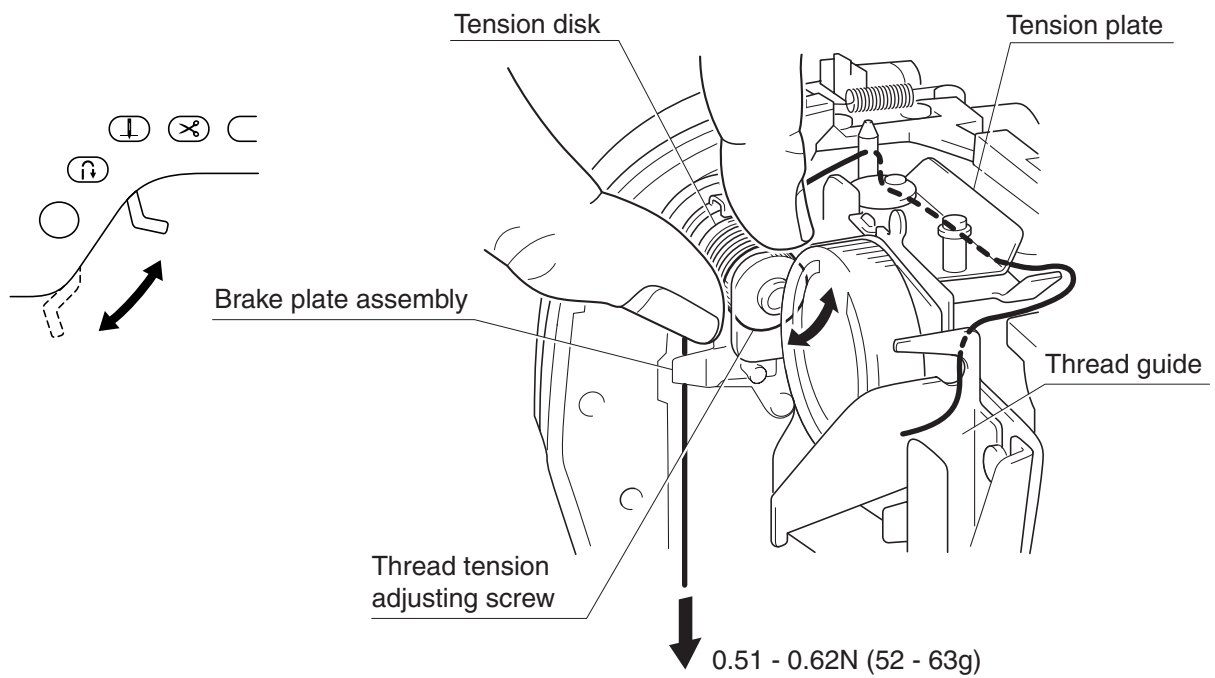

1. Check that there is no step between the thread guide cover A and the thread guide cover B before adjustment.
2. Rotate the thread tension dial counterclockwise until it stops (Fig. 1).
3. Loosen the pan head screw (S/P washer, M3X6) securing the link A shaft plate assembly (Fig. 2).
4. Move the link A shaft plate assembly to adjust the clearance between the thread guide shutter and the thread guide cover to 2.0 to 3.0 mm (Fig. 3).
5. Tighten the pan head screw (S/P washer, M3X6) to secure the link A shaft plate assembly (Fig. 2).
6. Rotate the thread tension dial clockwise until it stops, and check that the clearance between the thread guide shutter and the thread guide cover is 0 mm (Fig. 4).

Fig. 1

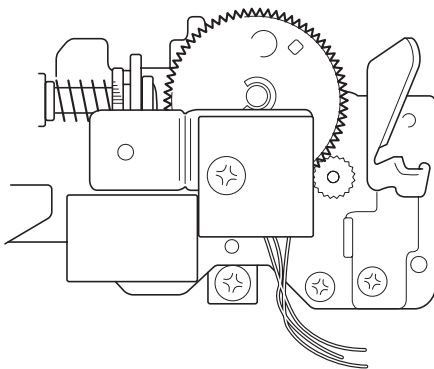

Fig. 2

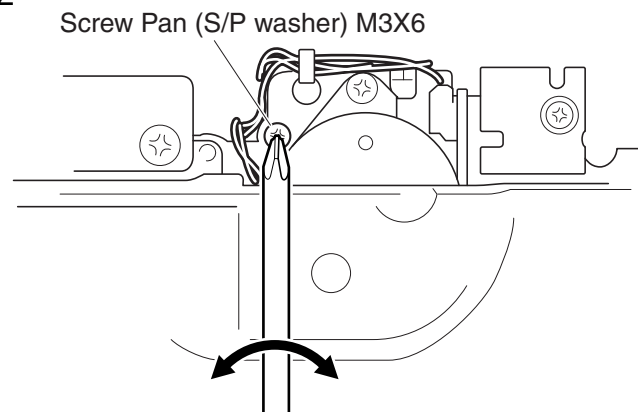

Fig. 3

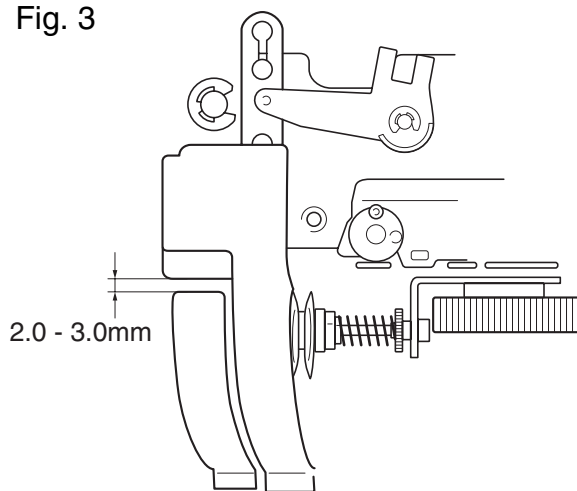
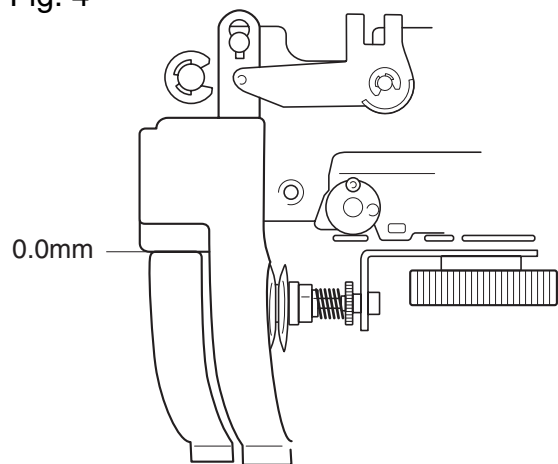
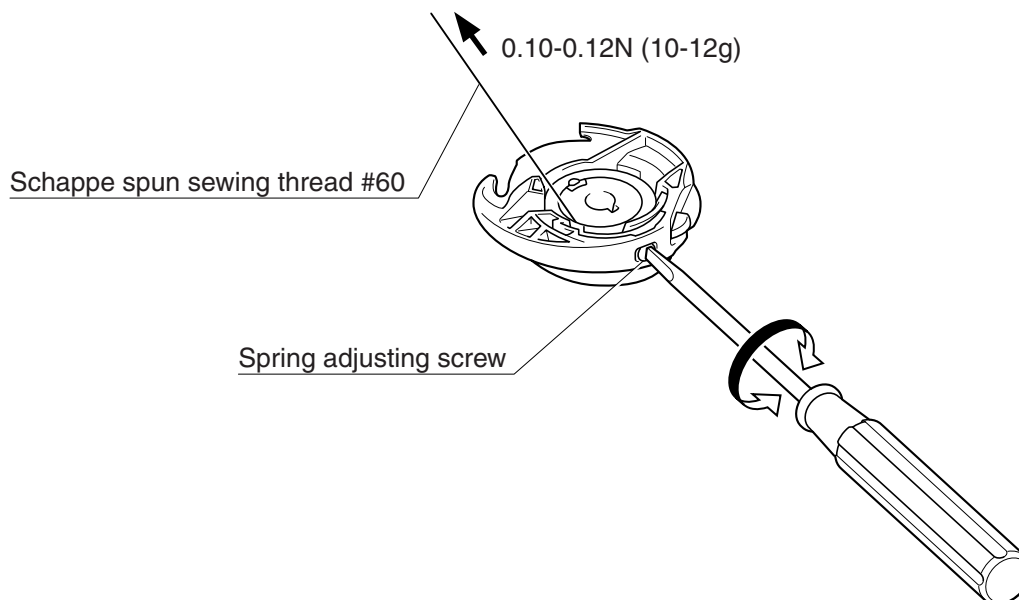

Fig. 4





1. Set a bobbin (wound with Schappe Spun Sewing Thread #60) to the inner rotary hook.
2. Pull the thread with a tension gauge, and adjust the tension to 0.10 to 0.12N (10 to 12g) using the spring adjusting screw.
3. Apply a small amount of screw lock agent to the spring adjusting screw.



1. Set the inner rotary hook in the outer rotary hook.
2. Loosen the screw (bind, M3X8) securing the inner rotary hook bracket assembly.
3. Adjust the position of the inner rotary hook bracket assembly so that the inner rotary bracket assembly contacts the inner rotary hook along 1.6 to 1.8 mm, and secure the inner rotary hook bracket assembly with the screw (bind, M3X8).

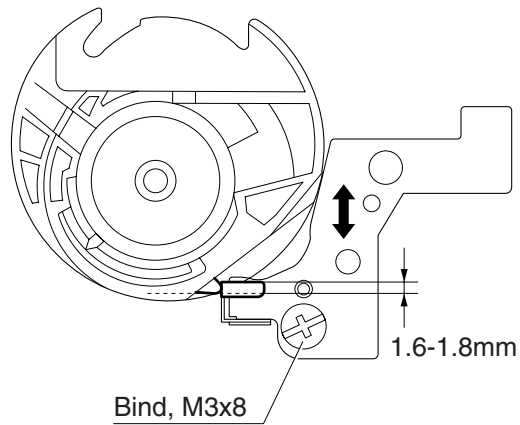

1. Attach J presser foot.
2. Start the test mode, and select test mode "02"
3. Turn the pulley by hand until the feed dog is lower than the needle plate.
4. Lower the presser lever, and then press [0] on the screen.
5. Raise the presser lever, and insert a 3 mm gauge.
6. Lower the presser lever, and press [3] on the screen.
7. Raise the presser lever, and remove the 3mm gauge.
8. Lower the press lever, and press [OK] of PF AM Adjust
9. Press [CLOSE].

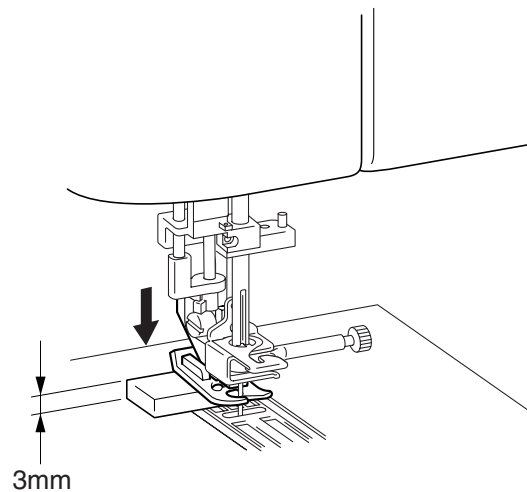
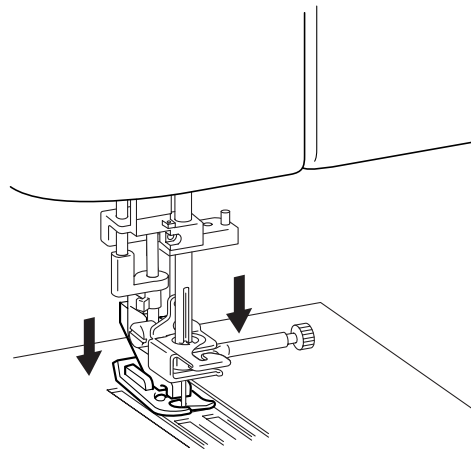
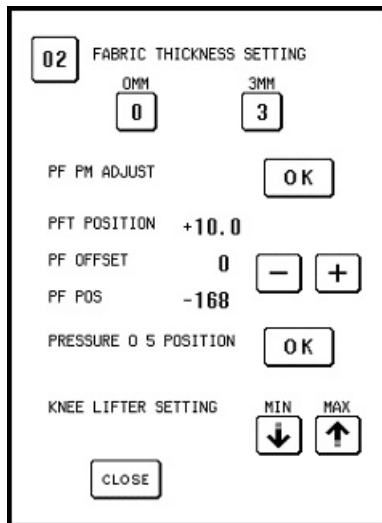

1. Turn the pulley to raise the feed dog to limit. (The D-cut of lower shaft B should be facing up.)
2. Adjust the bolt ① so that the far back tooth of the feed dog is 0.9 to 1.1 mm from the top face of needle plate A.
3. Loosen the bolt ②, and then tighten it again.
4. Adjust the bolt ③ so that the feed dog is at the parallel.  
(After adjustment, check that the front tooth is level with the far back tooth of the feed dog.)

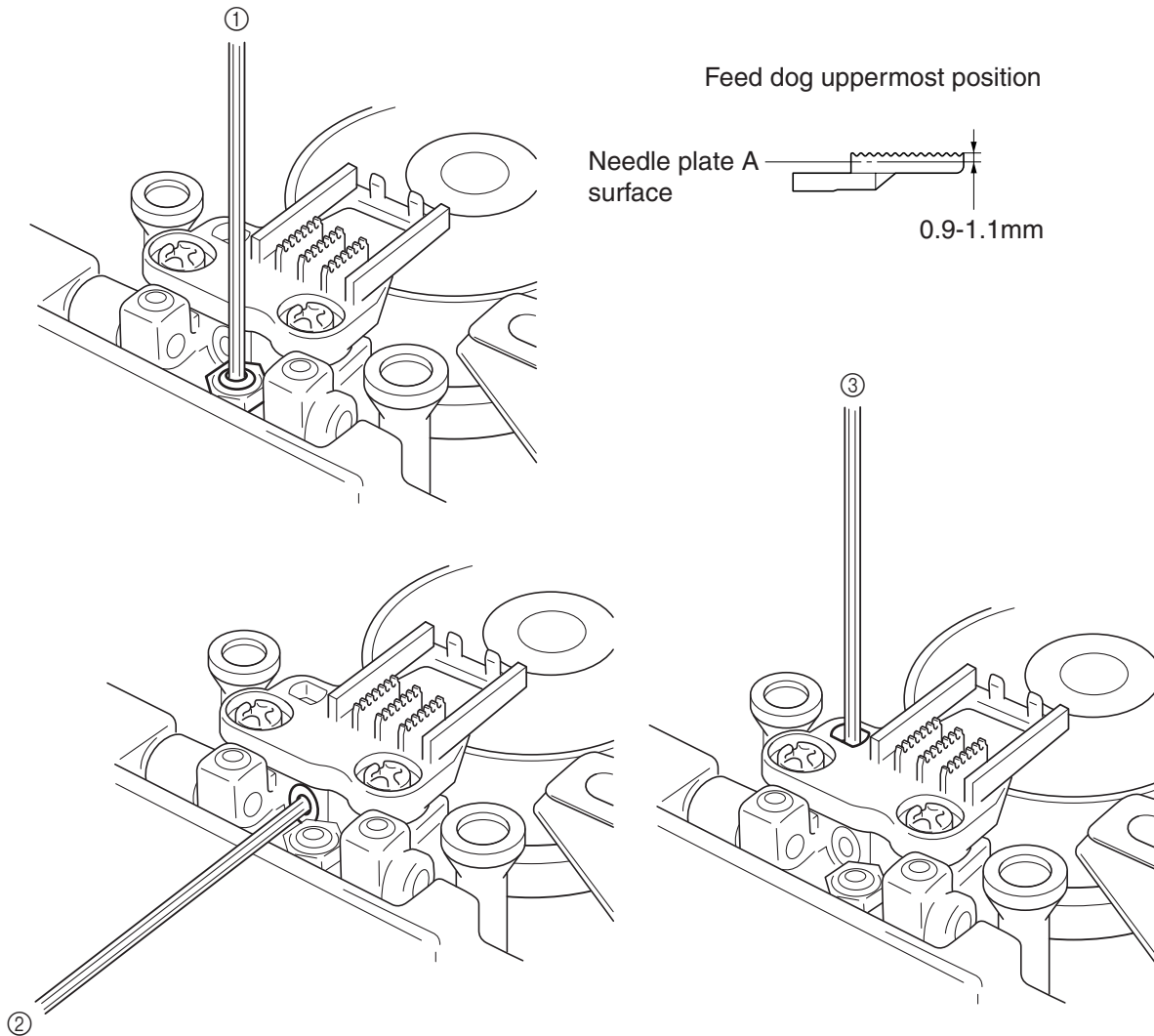

1. Start the test mode, and select test mode "6".
2. Select the  key. (Set the feed to "0" and the feed dog to center.)
3. Loosen the 2 screws (bind, M3X8), temporarily attach needle plate A, and adjust the front/back and left/right right positions of the feed dog.

**\*Key point**

- Adjust the clearance between the forward edge of the feed dog middle tooth and needle plate A to 3.2 to 3.8 mm.
  - Adjust the clearance (left/right) between the feed dog and needle plate A to be equal.
  - Do not allow the feed dog to engage needle plate A at an angle.
4. Secure the feed dog with 2 screws (bind, M3x8).
  5. Fully tighten the M4 screws to secure needle plate A.

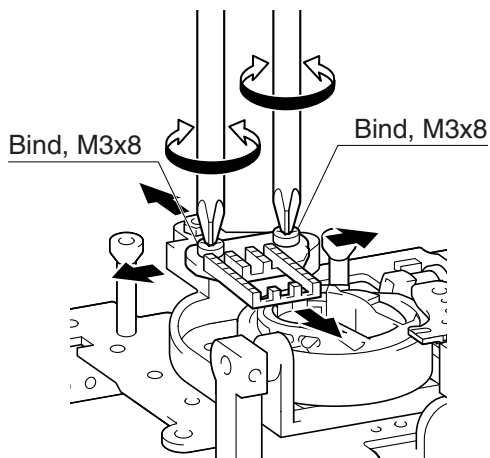
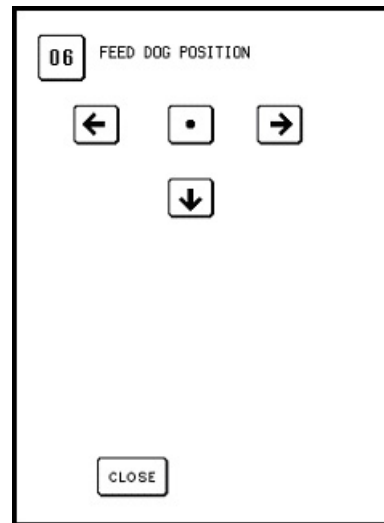
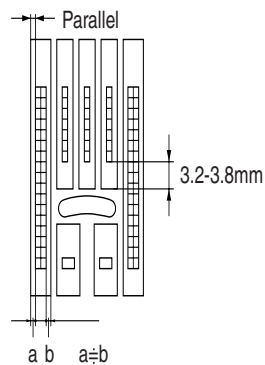

1. Attach J presser foot.
2. Remove the front cover, and turn the power on while pressing [SW3] and [SW4] on the main PCB assembly. (Select [13] in test mode.)
3. Press [SW2] to enter "Feed forward and backward mode."
4. Press [SW1] to run the machine in "Feed forward and backward mode," checking the forward and backward feed length.
5. Loosen the screw (3X8) securing the FPM holder assembly.
6. Adjust the forward and backward feed length using the FPM holder assembly screw (4X25).

**\*Key point**

- After feeding the two layers of broadcloth with a sheet of paper inserted between them, forward and backward for 100 stitches, check that the forward feed length is  $0 \pm 5.0\text{mm}$  longer than the backward feed length.
- Tightening the screw (4X25) increases the backward feed length.
- Loosening the screw (4X25) decreases the backward feed length.

**NOTE**

- Main PCB is likely to be damaged when tool touch the PCB attached FPM. When adjustment, turn the power off surely.

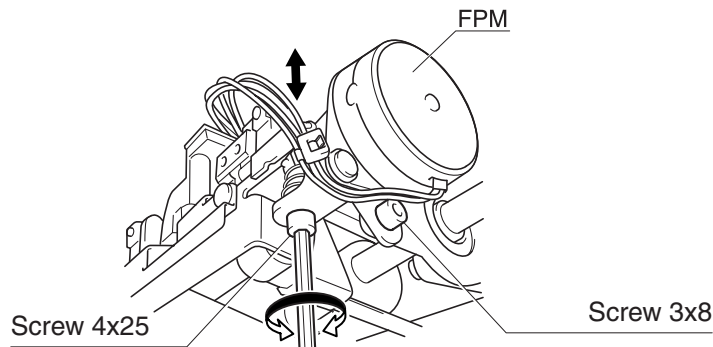

Feed module lower right

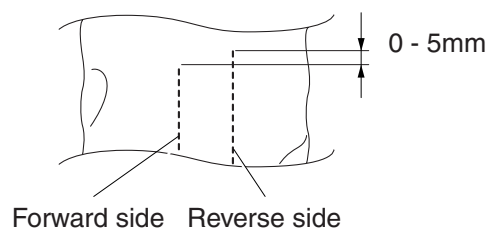
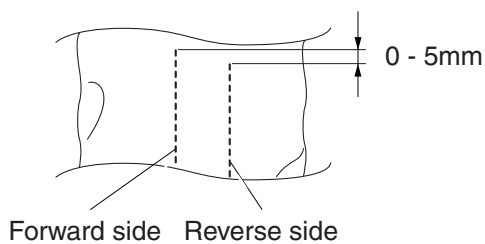



1. Attach N presser foot.
2. Start the test mode, and select test mode "36", and check sewing condition using Schappe Spun Sewing Thread #60.
3. Adjust the following so that the pattern shape is appropriate:
  - ① Adjust the feed dog height and alignment so that the U-shape is almost on the right and the sewing length at the upper section is 26.0 to 31.0 mm.

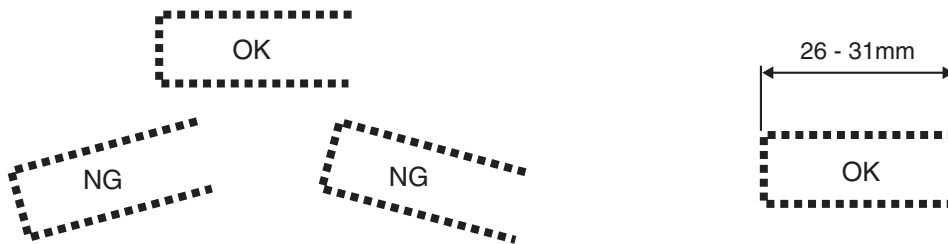

- ② Adjust the skew feed correction value so that the vertical clearance on the right is 4.0 to 6.0 mm.

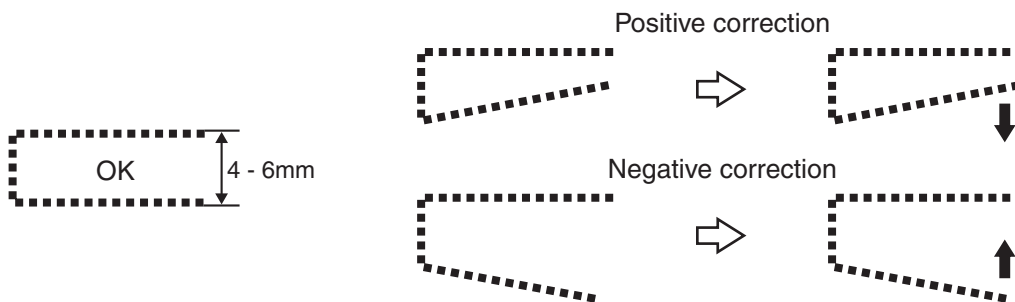

- ③ Adjust the left/right length correction value so that the difference between the upper and lower length is 1.0 mm or less.

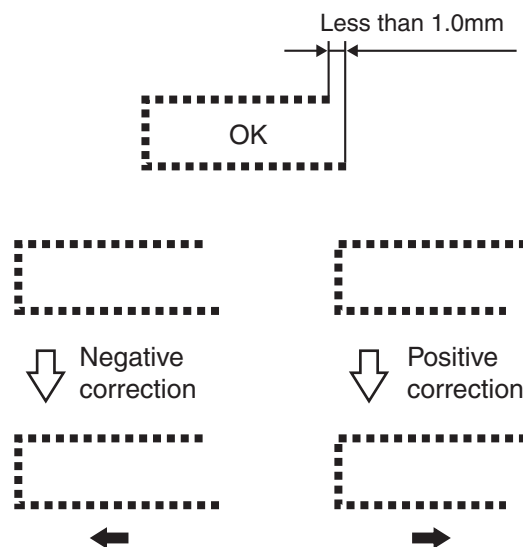

1. Attach N presser foot.
2. Start the test mode, and select test mode "03"
3. Press the [Start/Stop] switch.
4. Adjust the correction value to prevent pattern overlapping, opening, and/or shift.

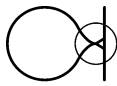

If the pattern is compressed in the ↓ direction, press the vertical [ + ] button. (A)

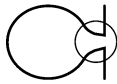

If the pattern is stretched in the ↓ direction, press the vertical [ - ] button. (B)



If the pattern is compressed in the ↔ direction, press the horizontal [ + ] button. (C)

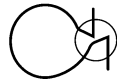

If the pattern is stretched in the ↔ direction, press the horizontal [ - ] button. (D)

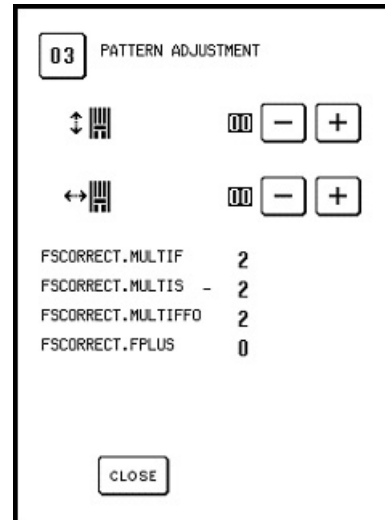

1. Move the tension guide assembly up and down to adjust the uneven bobbin winding.

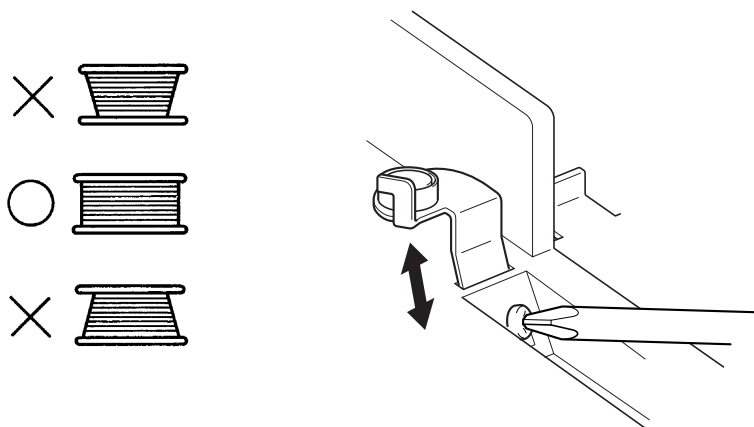

1. Start the test mode, and select test mode "02"
2. Turn the pulley by hand until the feed dog is lower than the needle plate top face.
3. Lower the presser lever, and press [MIN] of the "KNEE LIFTER SETTING".
4. Insert the knee lifter lever, and press [MAX] with the knee lifter lever fully turned to the right.
5. Press [CLOSE].

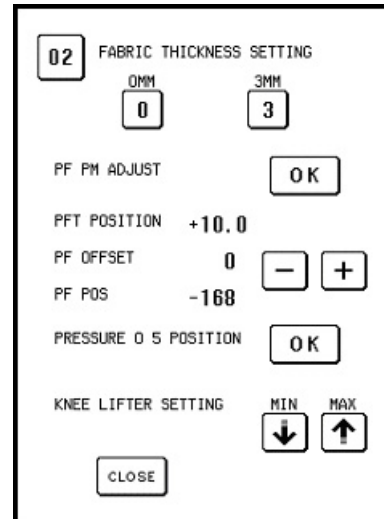
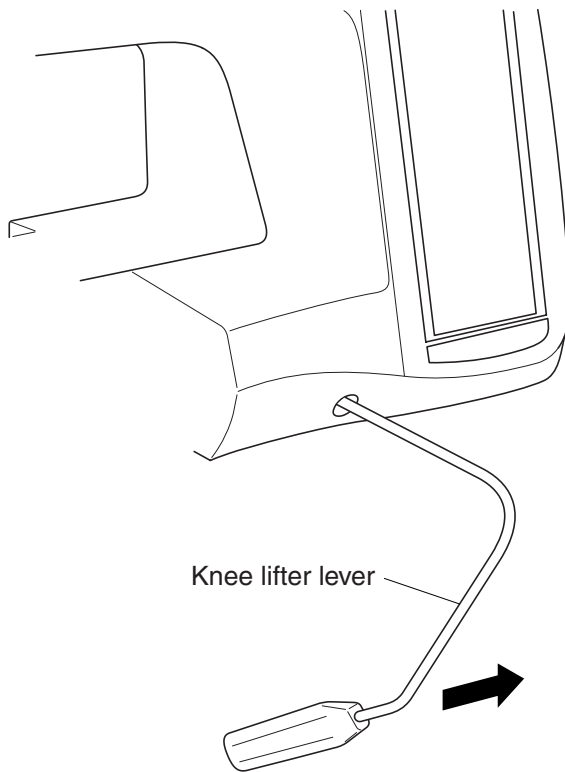
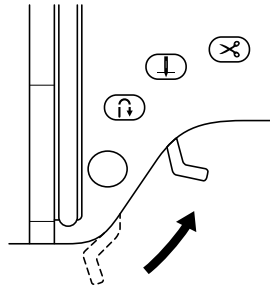

1. Raise the presser foot lifter.
2. Set the BH presser to a point two pitches less than the maximum length.
3. Attach the BH presser.
4. Lower the presser foot lifter.
5. Lower the BH lever, and set it to the BH presser.
6. Rotate the BH eccentric shaft so that BH0 contacts BH1.

**\*Key point**

- With the presser foot lifter raised, pull the BH presser forward as much as possible, and check that BH0 comes into contact with BH2 and that BH2 has some deflection.
- With the presser foot lifter raised, push the BH presser back as much as possible, and check that BH0 comes into contact with BH1 and that BH1 has some deflection.

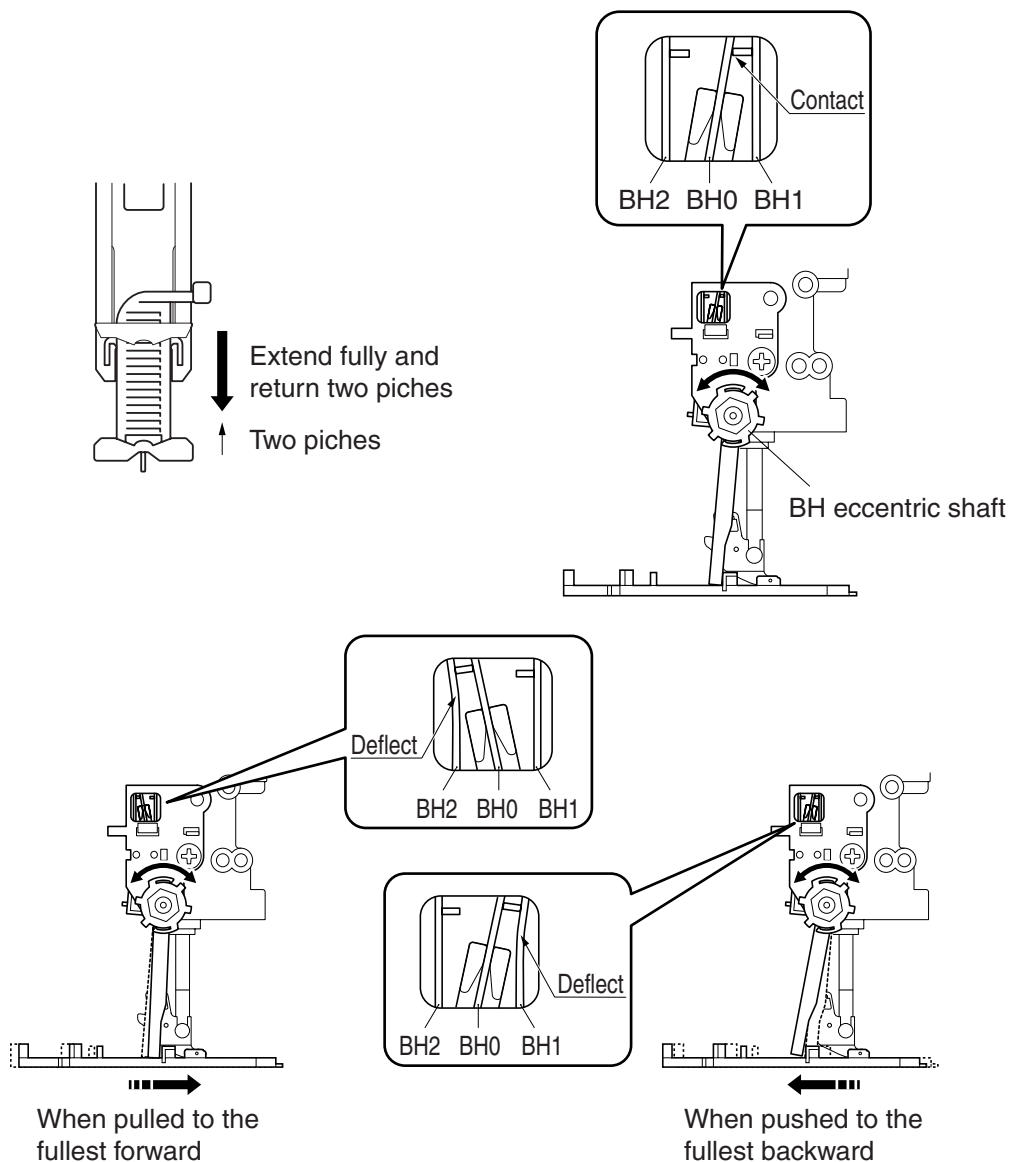

1. Loosen the 2 screws ❶.
2. Move the tension pulley plate assembly right and left to adjust the X-belt tension.
3. Tighten the 2 screws ❶.  
Load when center of X-belt is deflected 6.0 mm: 2.254 to 2.646N (230 to 270g)

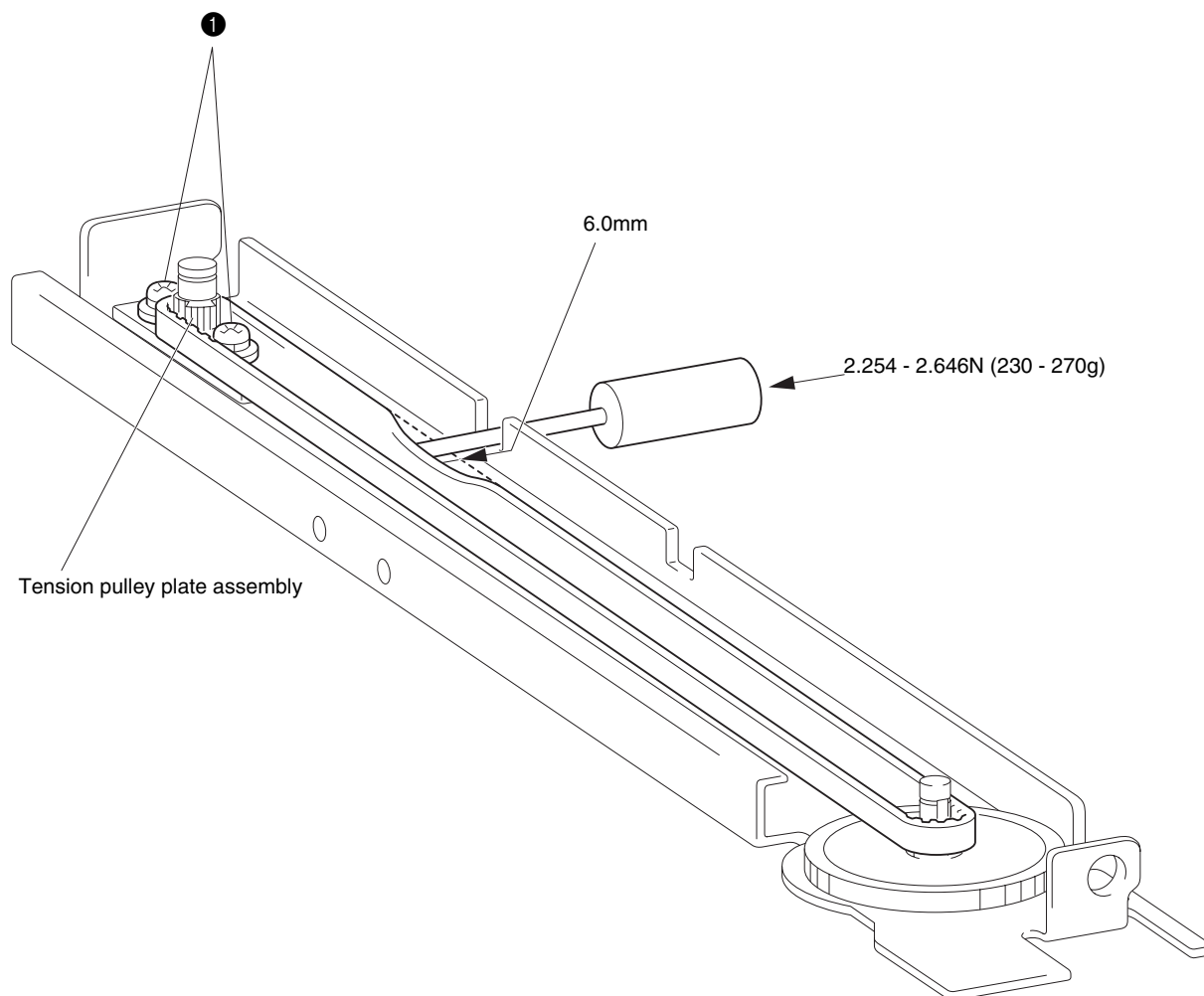



1. Loosen the 2 screws ❶.
2. Move the tension pulley plate assembly right and left to adjust the Y-belt tension.
3. Tighten the 2 screws ①.  
Load when center of Y-belt is deflected 6.0 mm: 1.28 to 1.67N (130 to 170g)

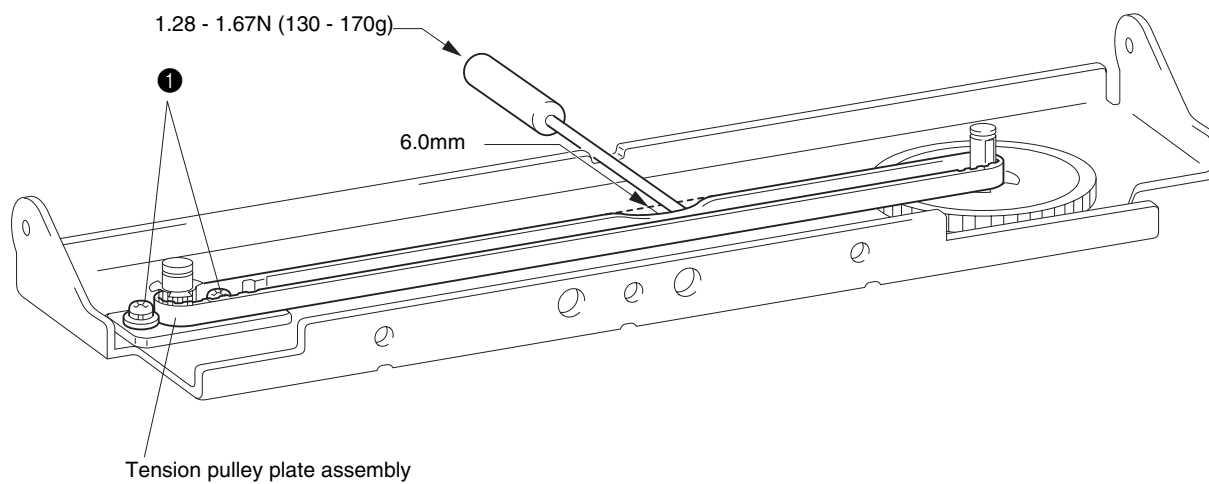

1. Attach the embroidery hoop to the machine and turn the power on.
2. Turn the power off.
3. Remove the embroidery hoop.
4. Loosen the screws securing the embroidery hoop stay plate.
5. Adjust the clearance between the ES main cover and the embroidery hoop stay plate to 3.3 to 3.7 mm at a position 5 mm from the right edge of the embroidery hoop stay plate.
6. Tighten the screws to secure the embroidery hoop stay plate.

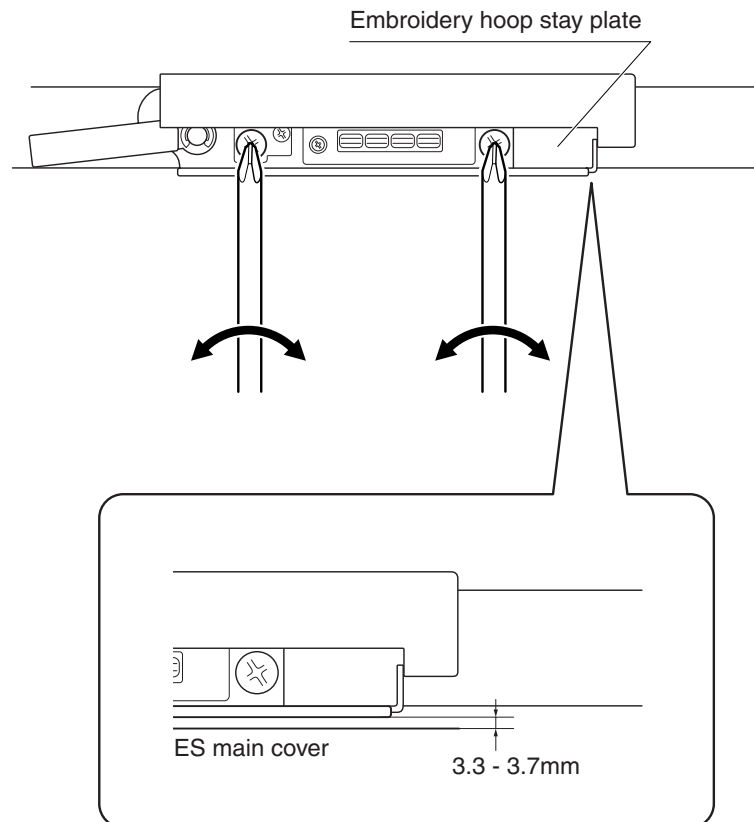

# 5 Failure Investigation for Electronic Parts

---

---

\* Perform resistance measurements after turning off the power, and detaching the connectors to be measured from the PCB.

Error message list .....	5 - 2
The power does not come on .....	5 - 3
Pulse motors do not return to starting point .....	5 - 5
The touch panel does not work .....	5 - 7
Main motor does not turn .....	5 - 8
Main motor rotation abnormal .....	5 - 10
Cannot sew pattern well .....	5 - 11
Cannot sew button holes well.....	5 - 12
Stitch length and zigzag width cannot be done by manual adjustment ...	5 - 13
Problems with vertical needle movement and reverse stitching....	5 - 14
Does not operate when the foot controller is used .....	5 - 15
Needle bar cutting and separating does not occur normally....	5 - 16
Thread tensioning does not go well.....	5 - 17
Thread cutter does not work normally .....	5 - 19
Bobbin winding cannot be done .....	5 - 20
The lamp at hand does not have light .....	5 - 21
Bobbin thread detection does not work normally .....	5 - 23
Upper thread sensor does not work normally.....	5 - 24
The presser foot lifter does not work correctly .....	5 - 25
Card cannot be used normally .....	5 - 27
The hoop sensor does not function normally .....	5 - 28
Embroidery unit does not operate normally.....	5 - 29
Unable to detect frame .....	5 - 32
Error is displayed.....	5 - 34

<b>Error display</b>	<b>Cause</b>
F01 (5 - 34)	Abnormal rotation in main motor.
F02 (5 - 35)	Key pressed continually with power ON (operation system SW).
F04 (5 - 36)	FC disconnect
F05 (5 - 37)	Dirty speed sensor
F06 (5 - 37)	NP sensor disconnect
F07 (5 - 38)	Speed VR disconnect
The safety device has been activated. Is the turned toggled? Is the needle bent?	No rotation in main motor.
A malfunction occurred. Turn the machine off, the on again *-PM	Each pulse motor has not returned to its original position.

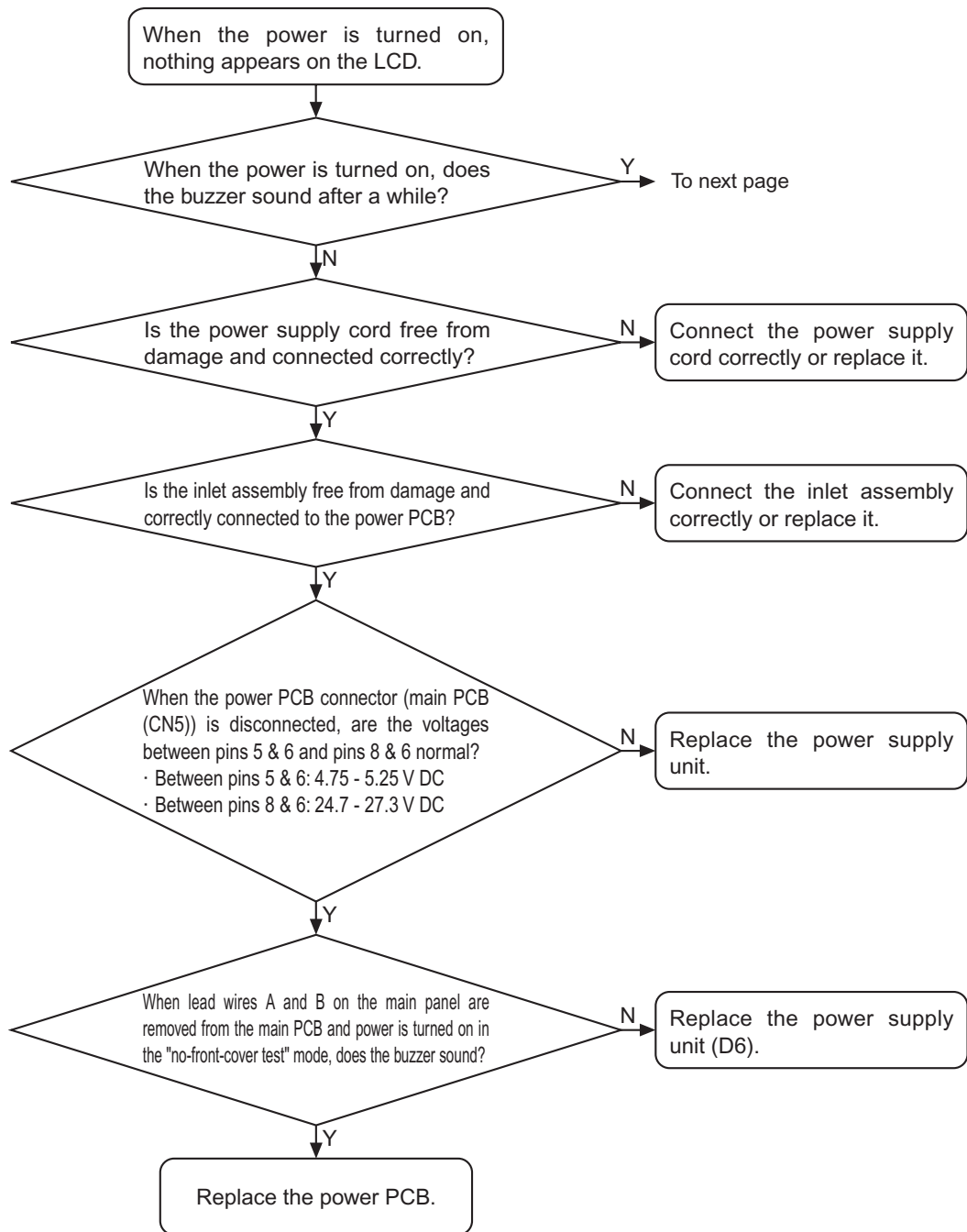

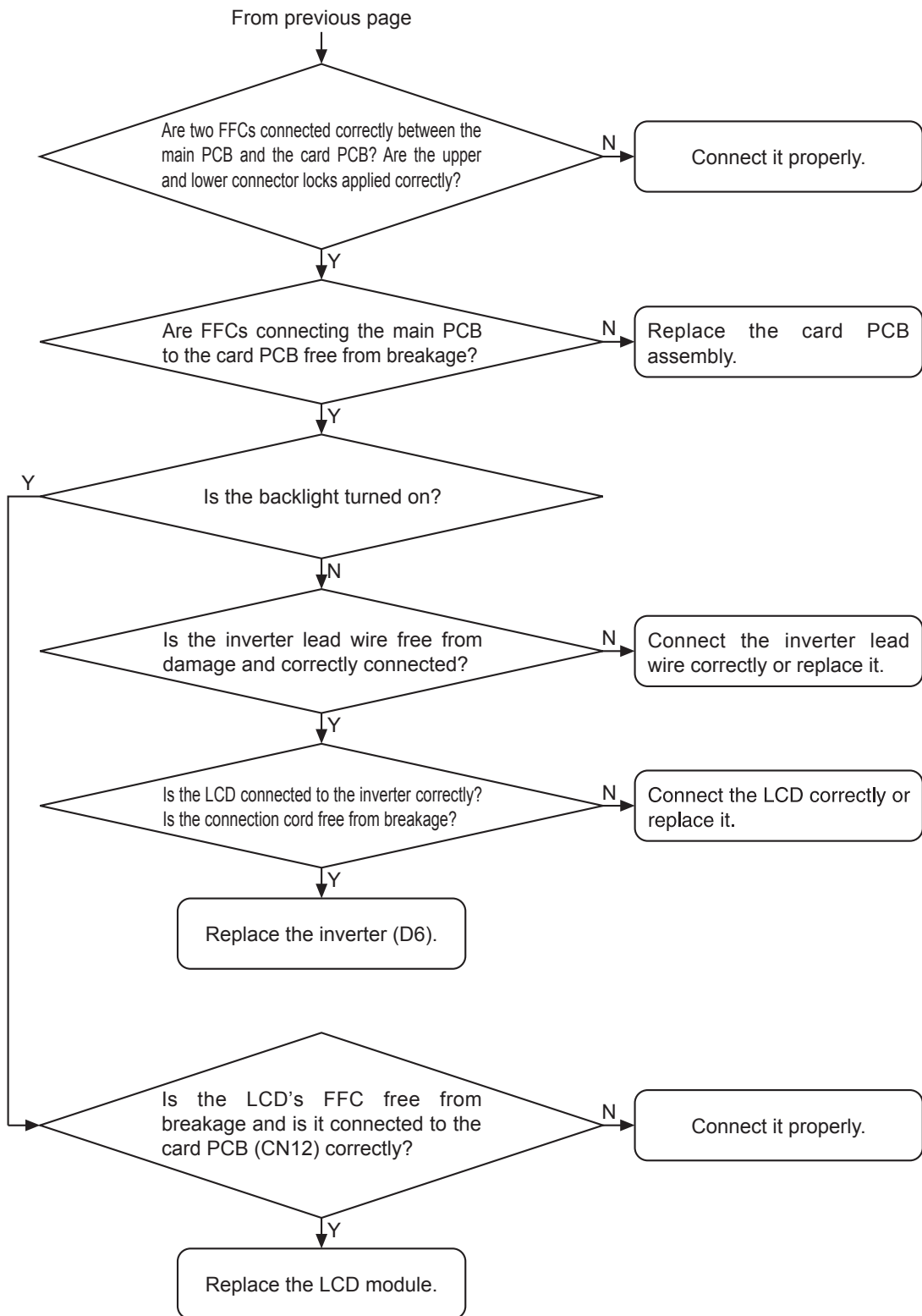



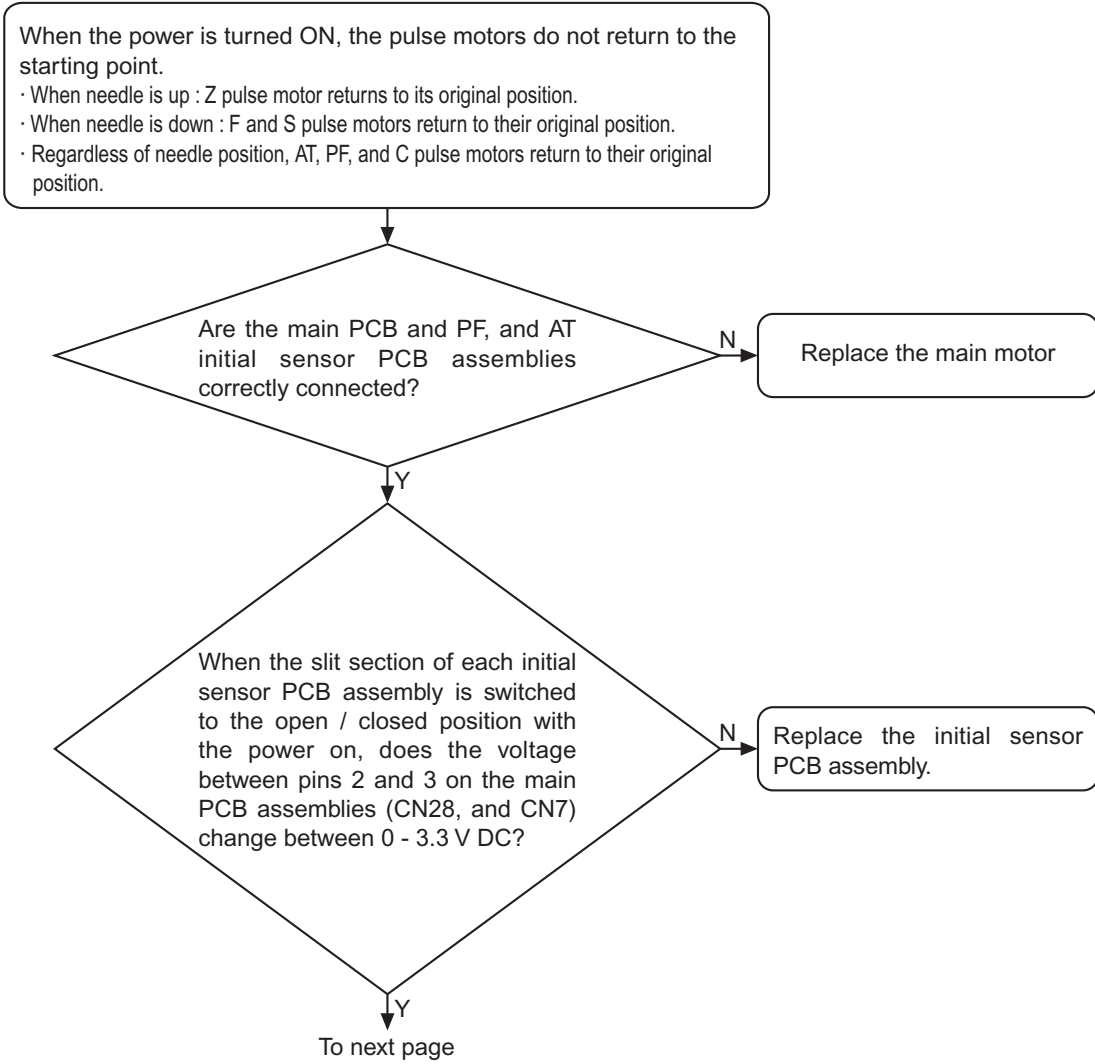

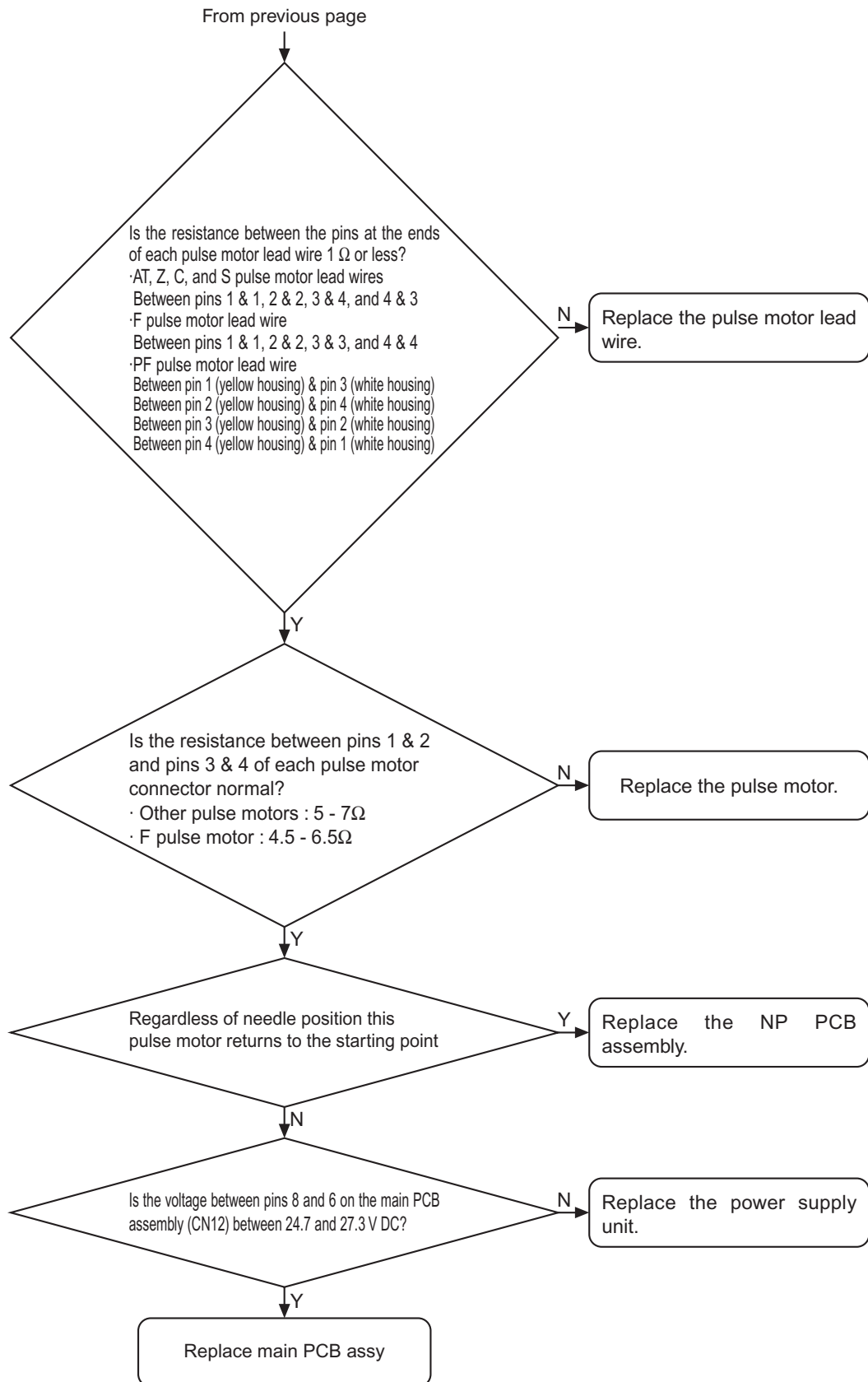

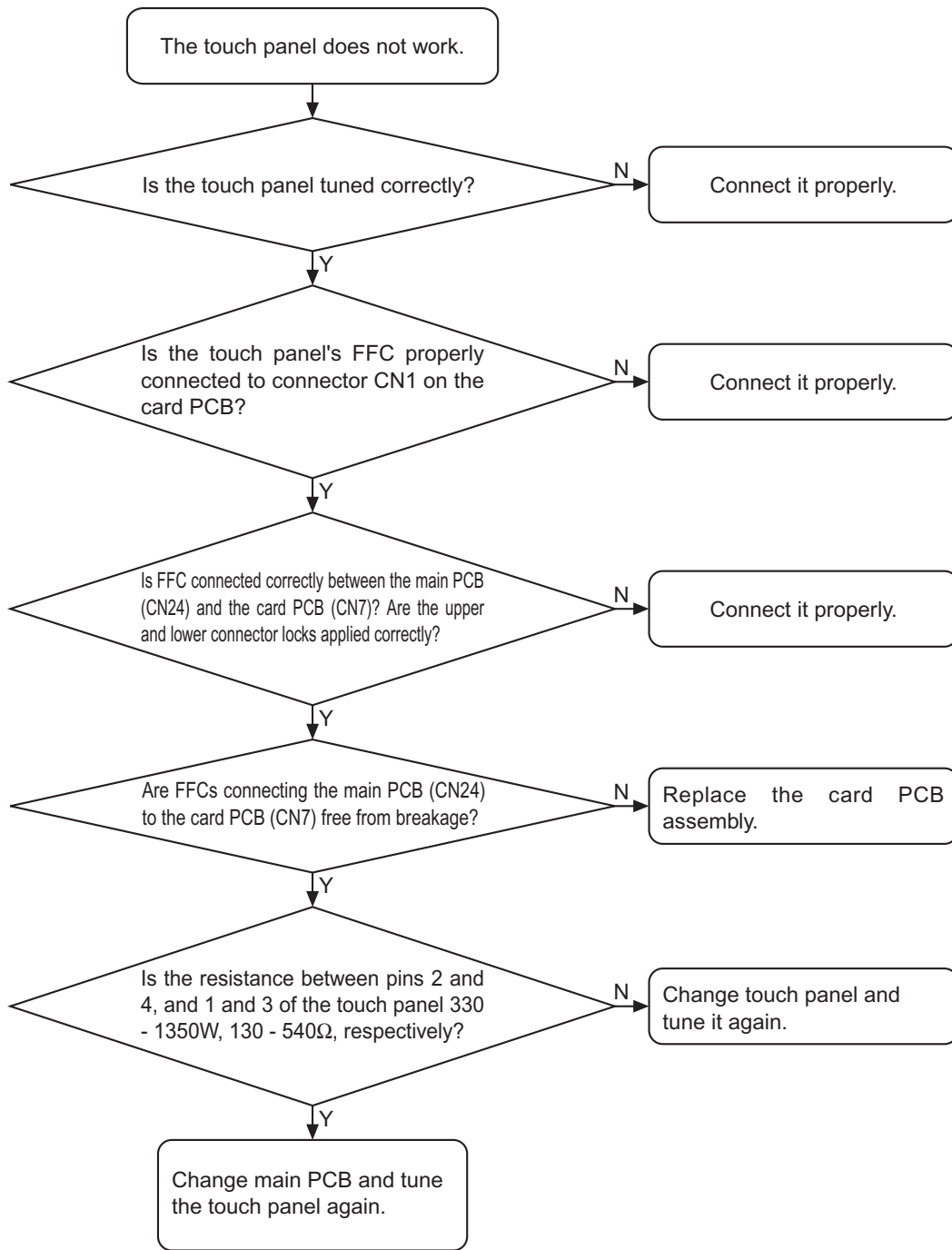

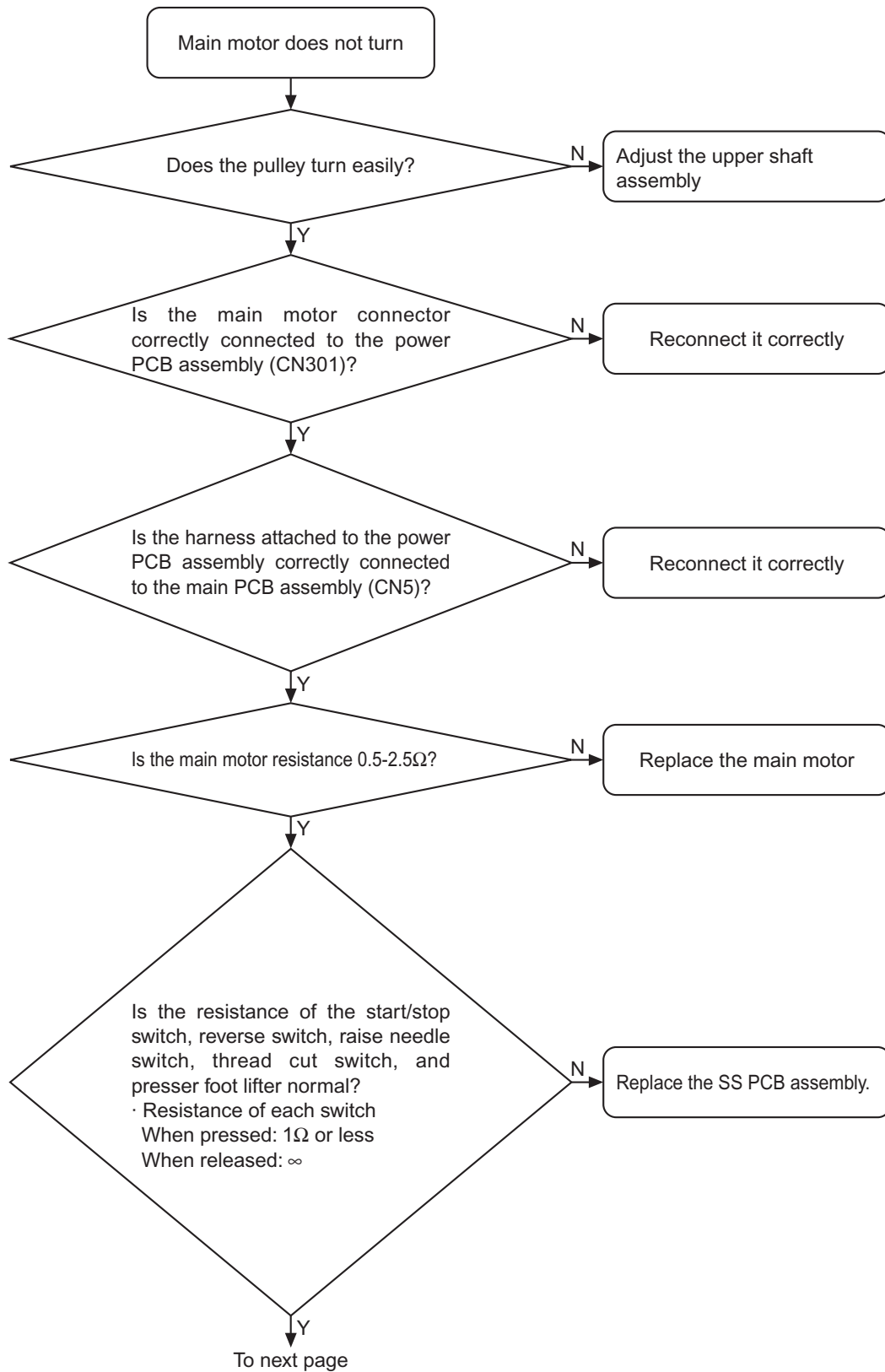

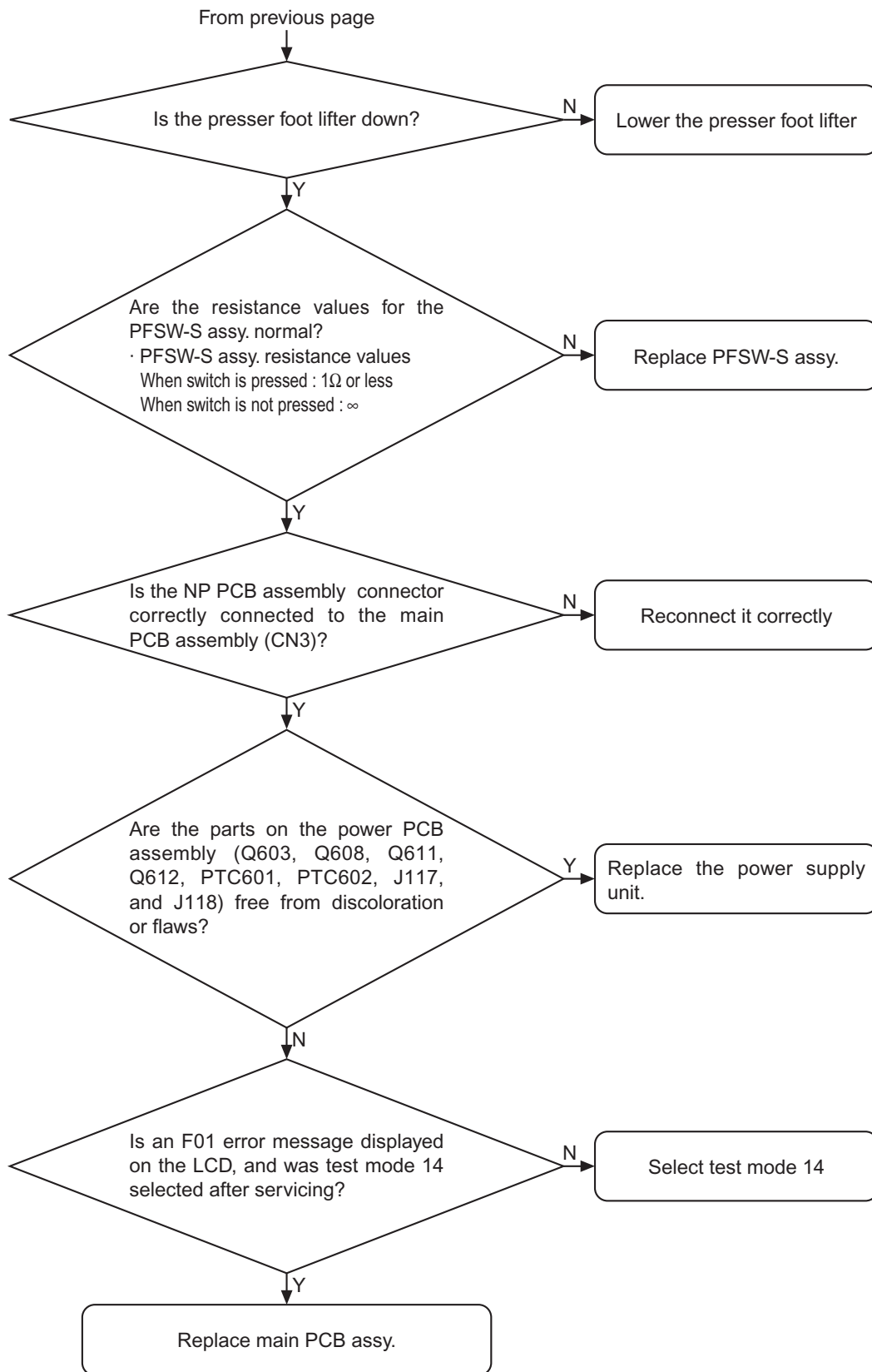

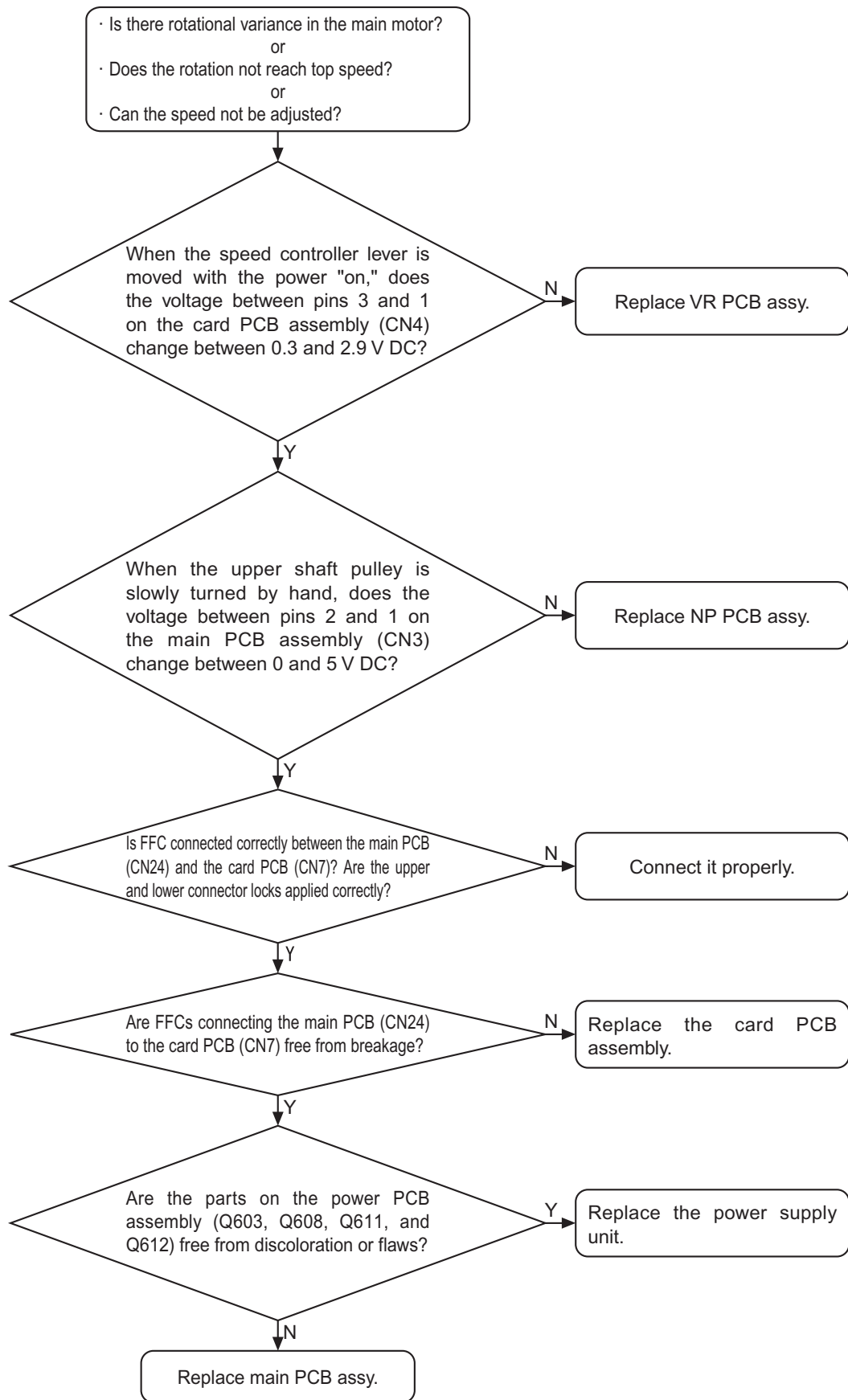



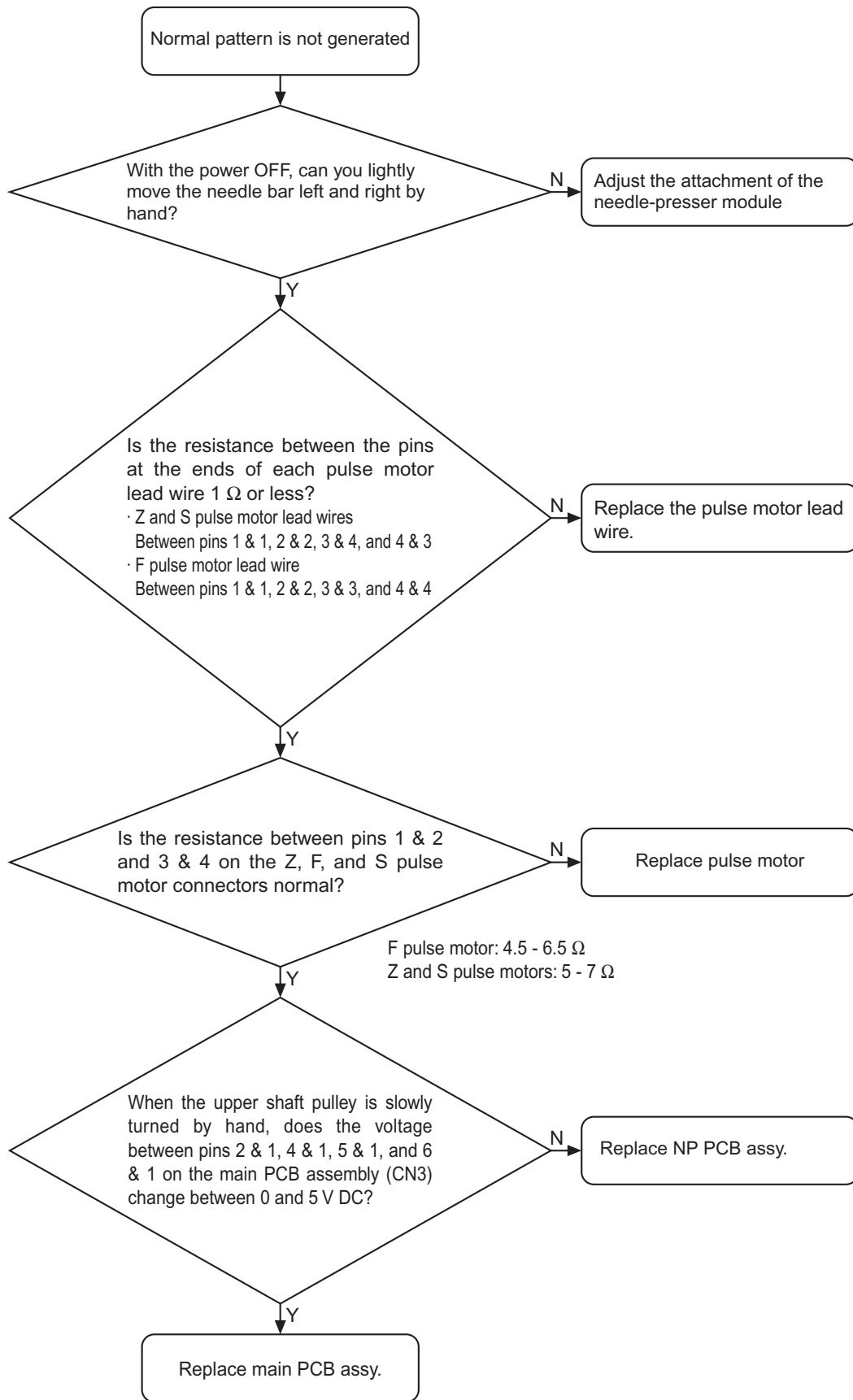

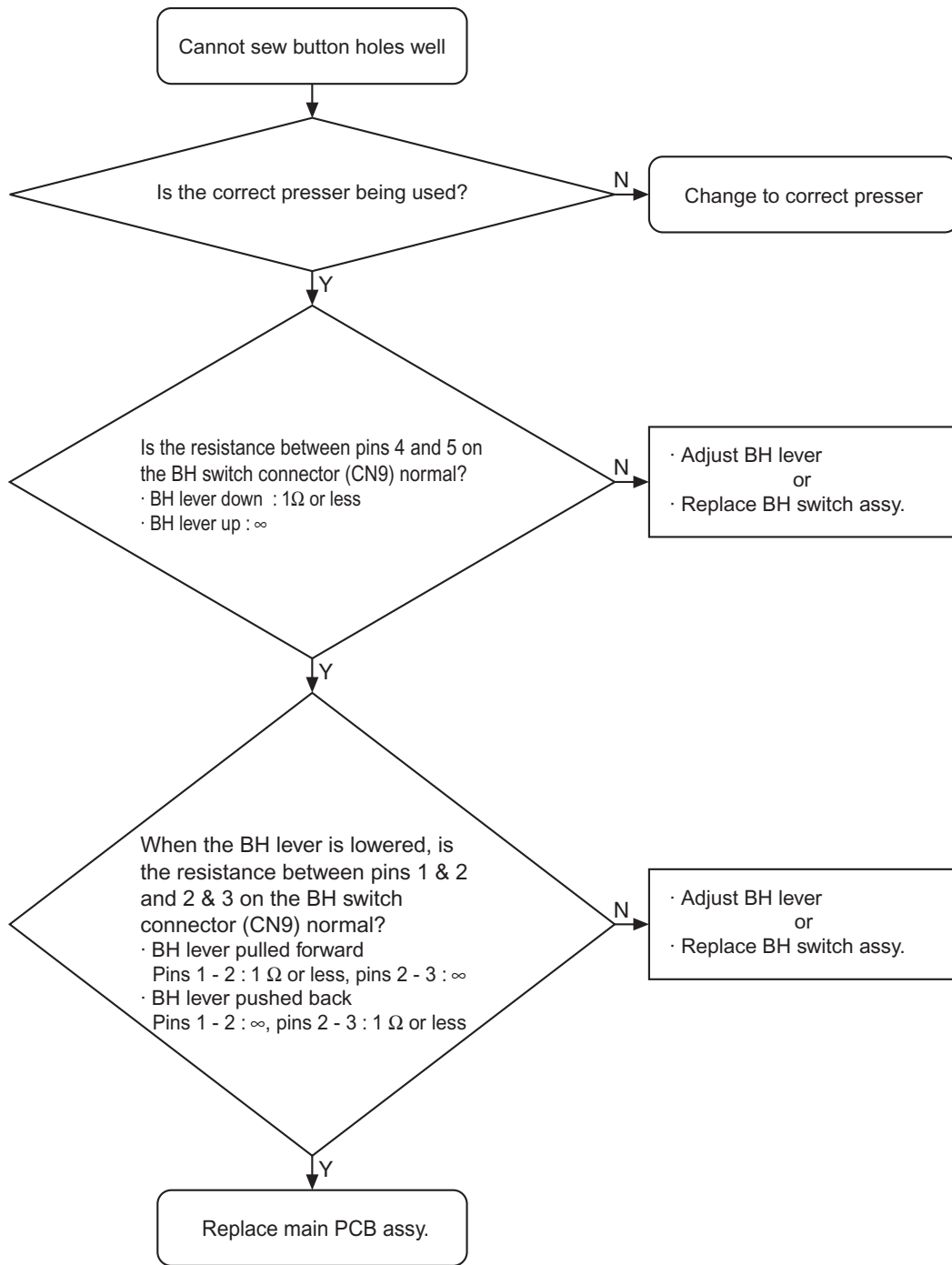

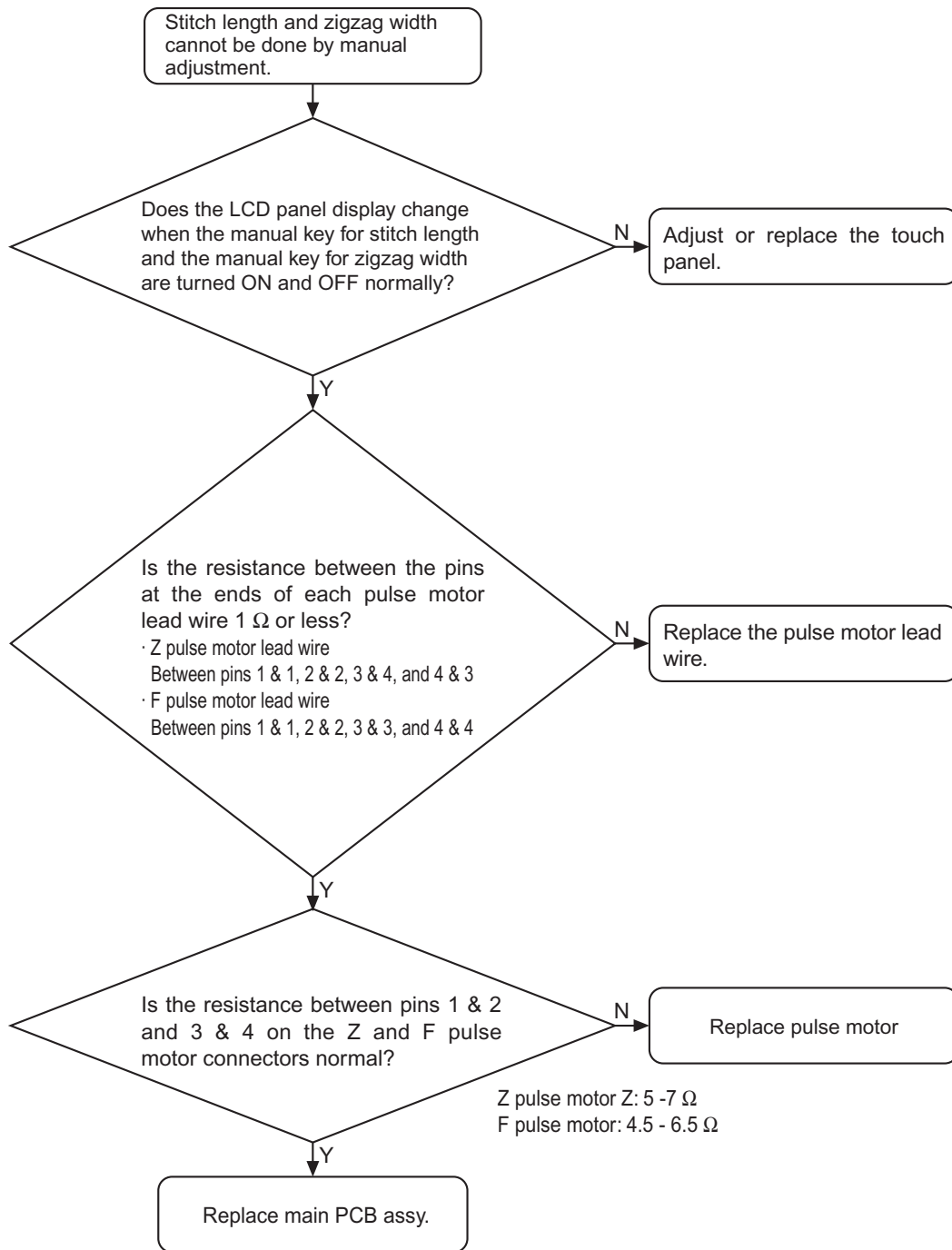

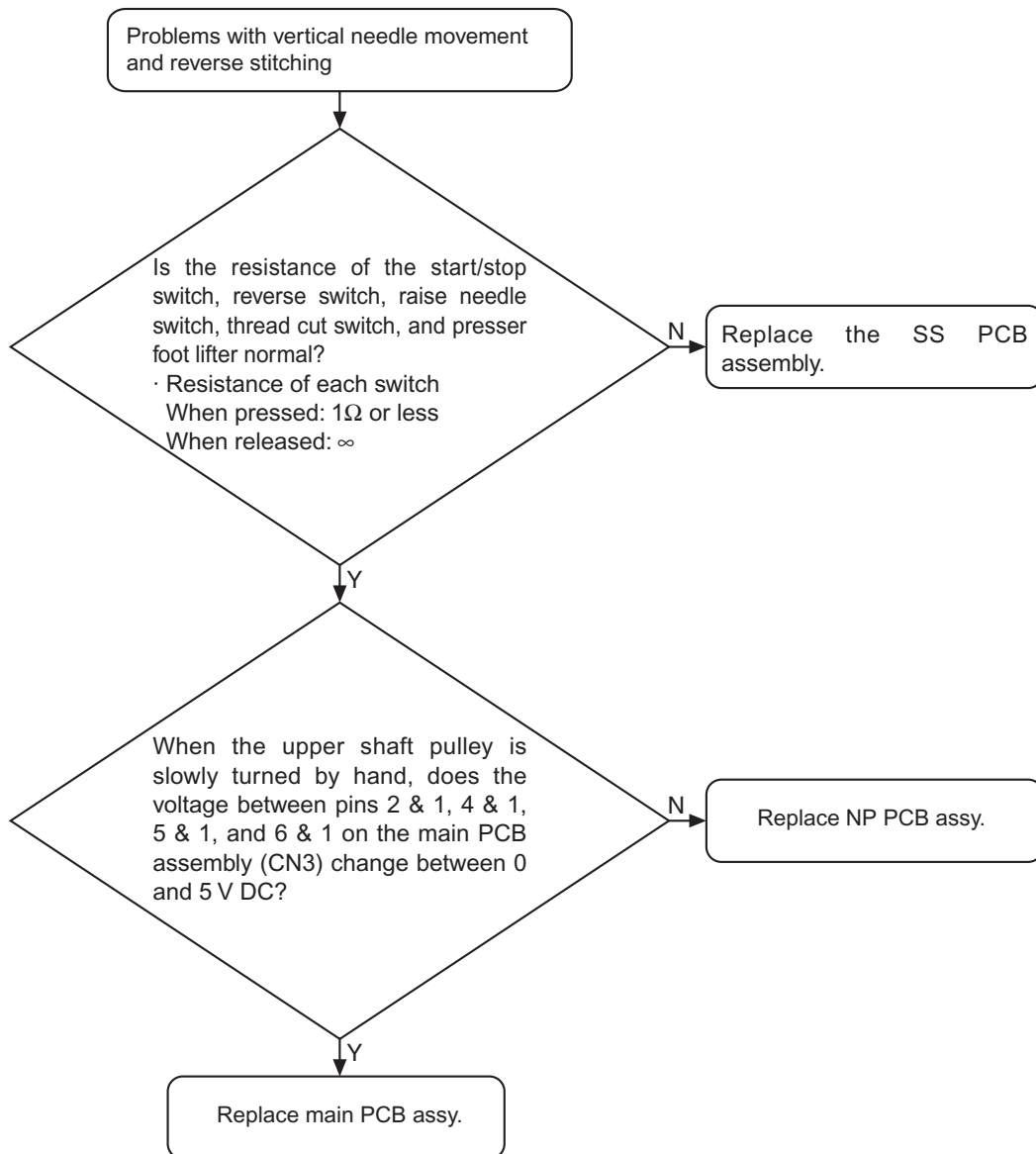

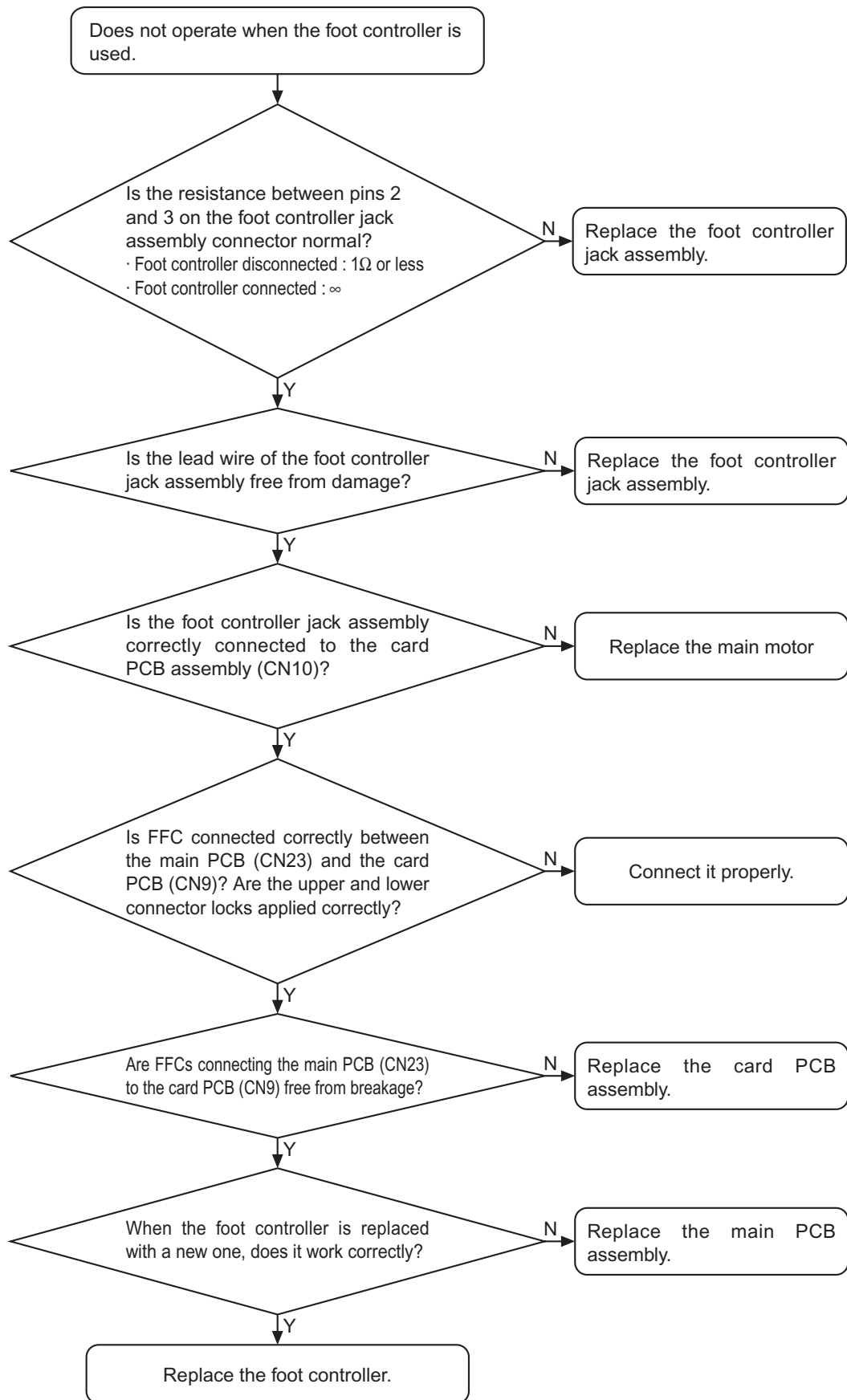

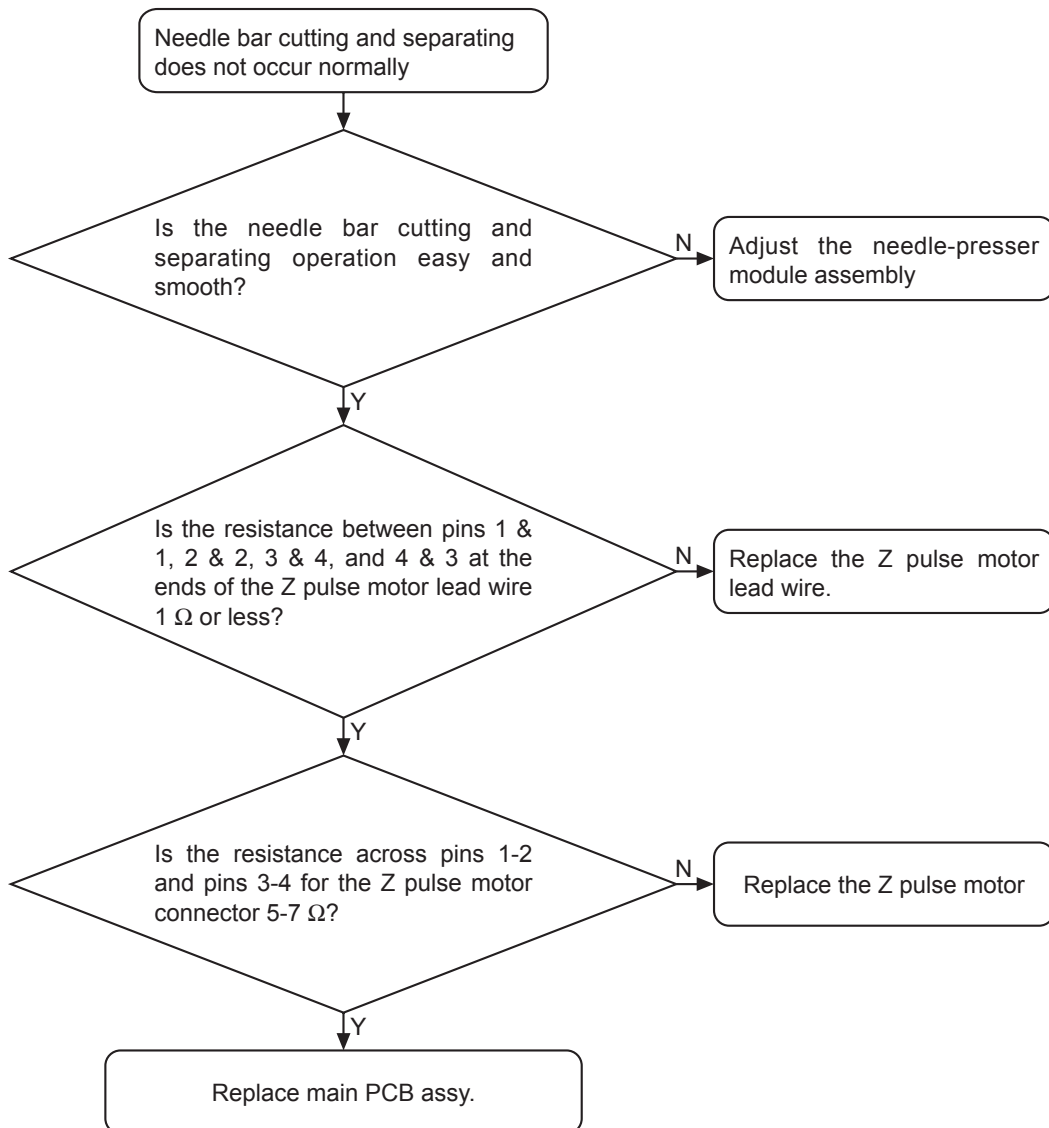



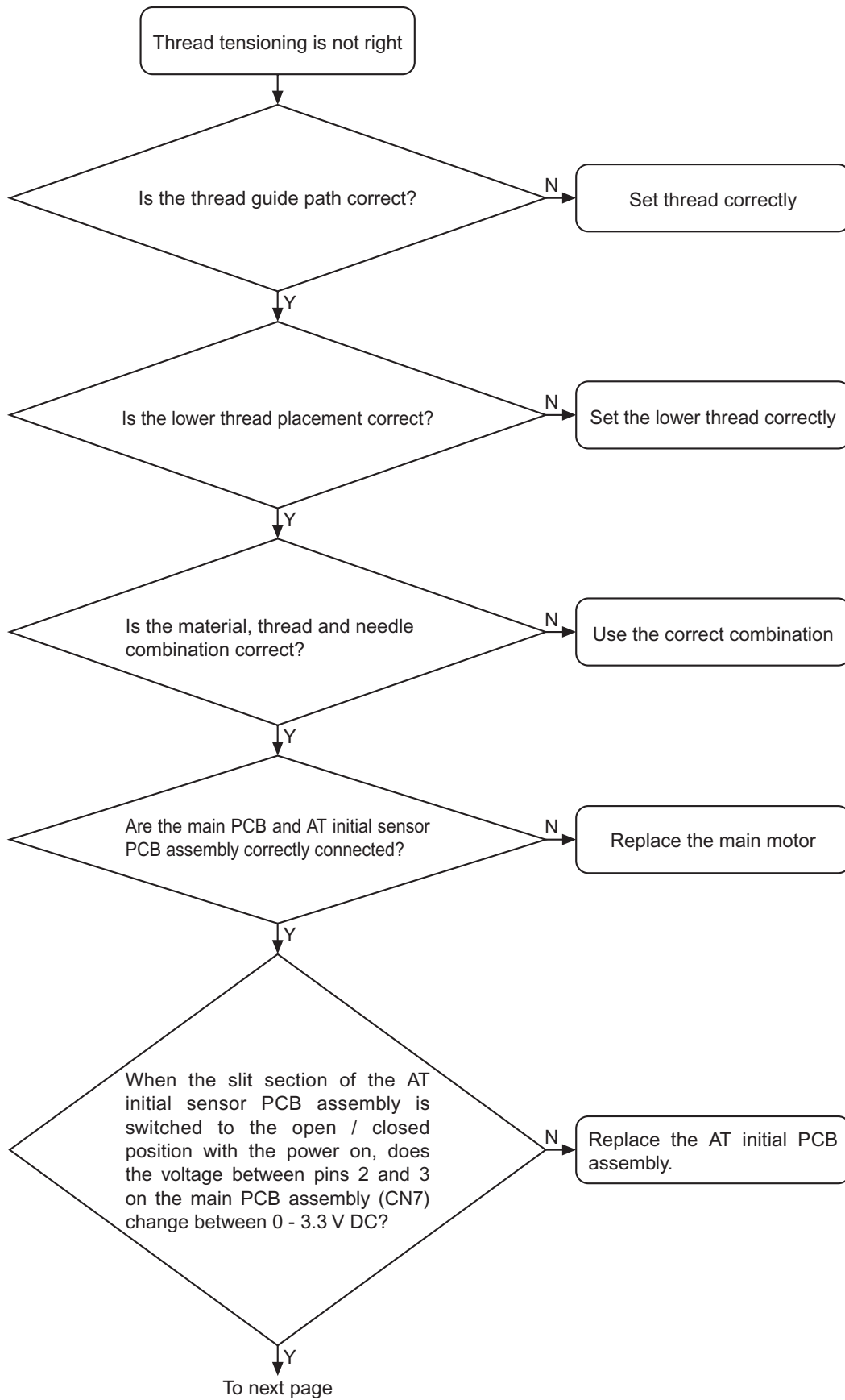

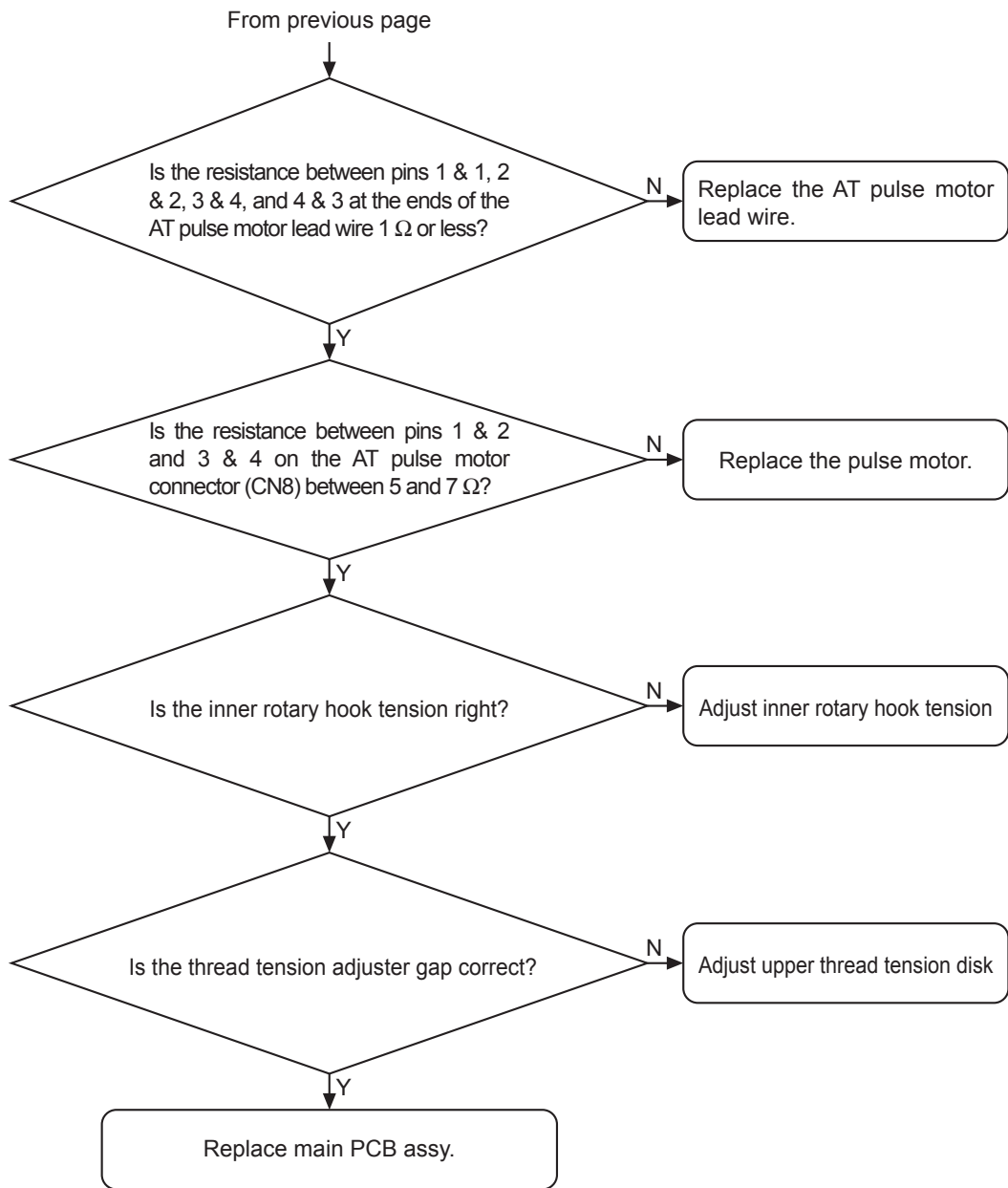

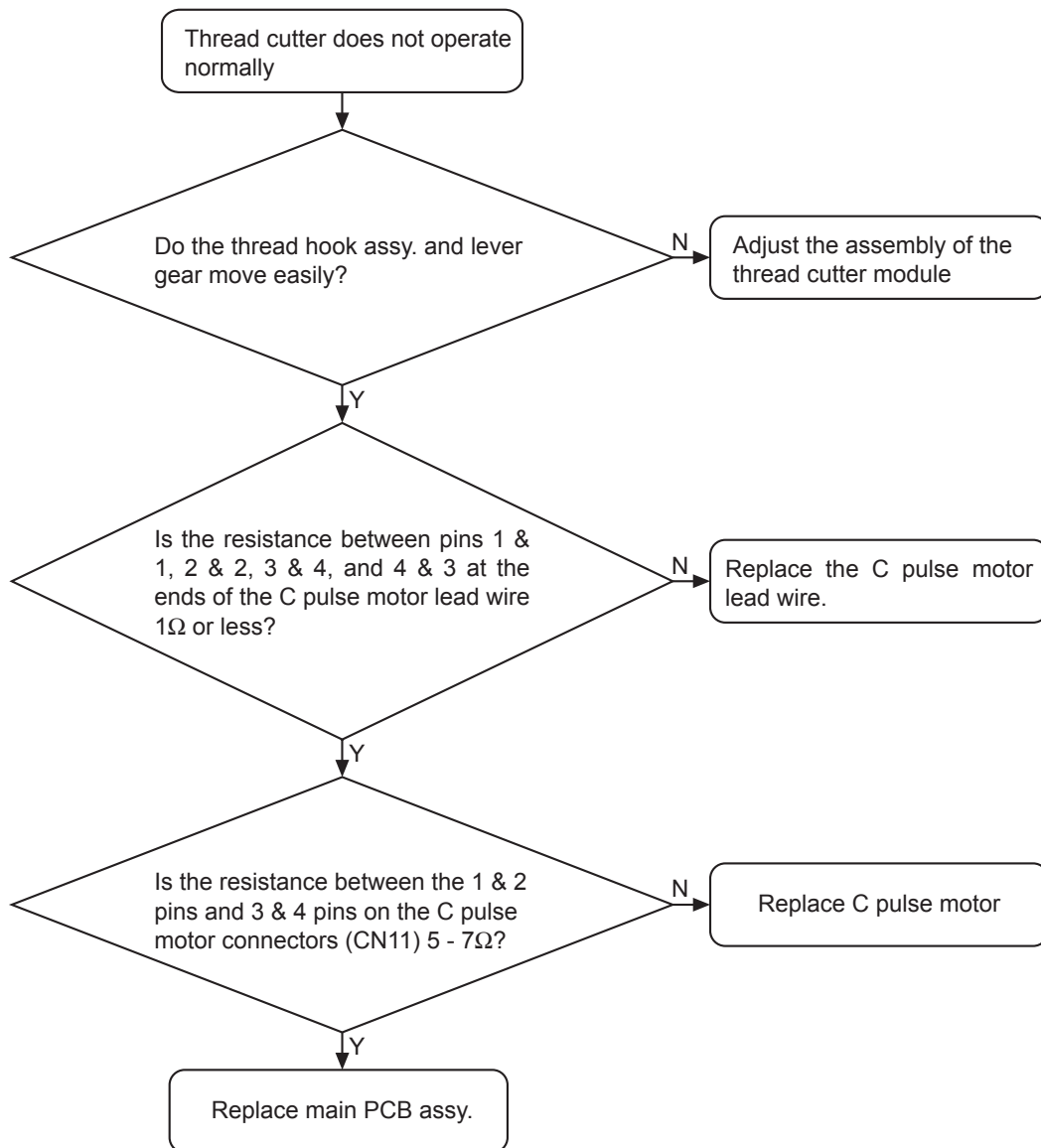

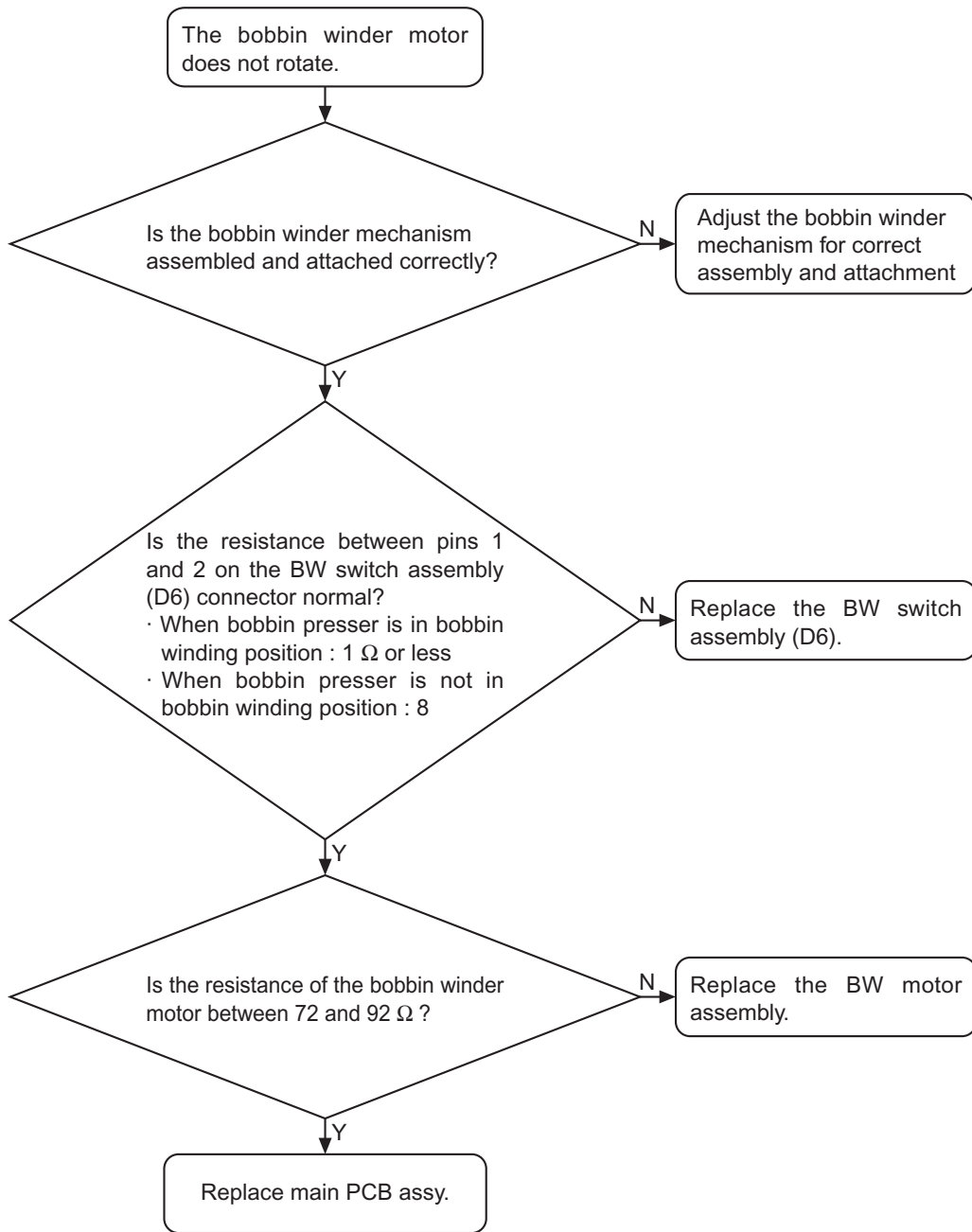

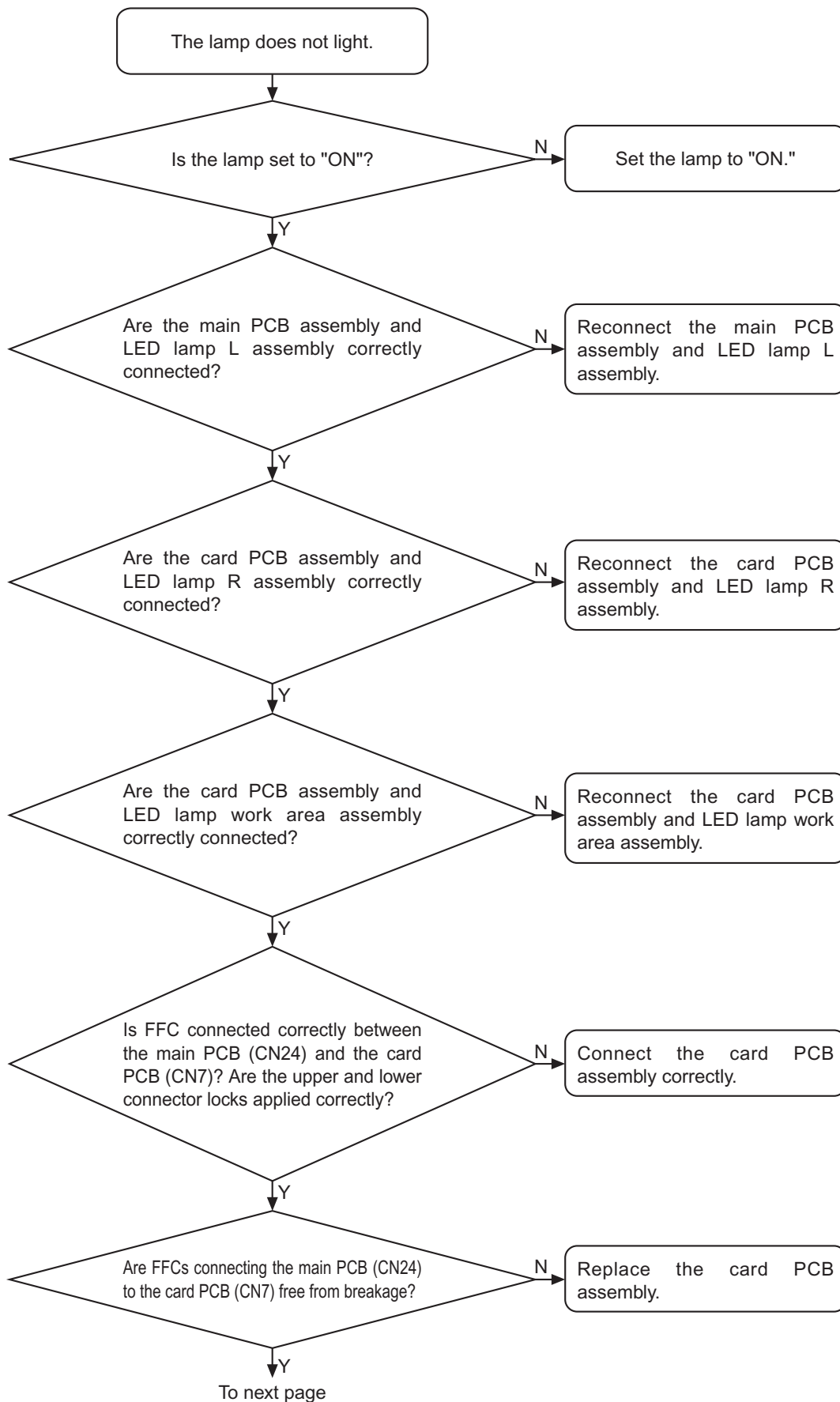

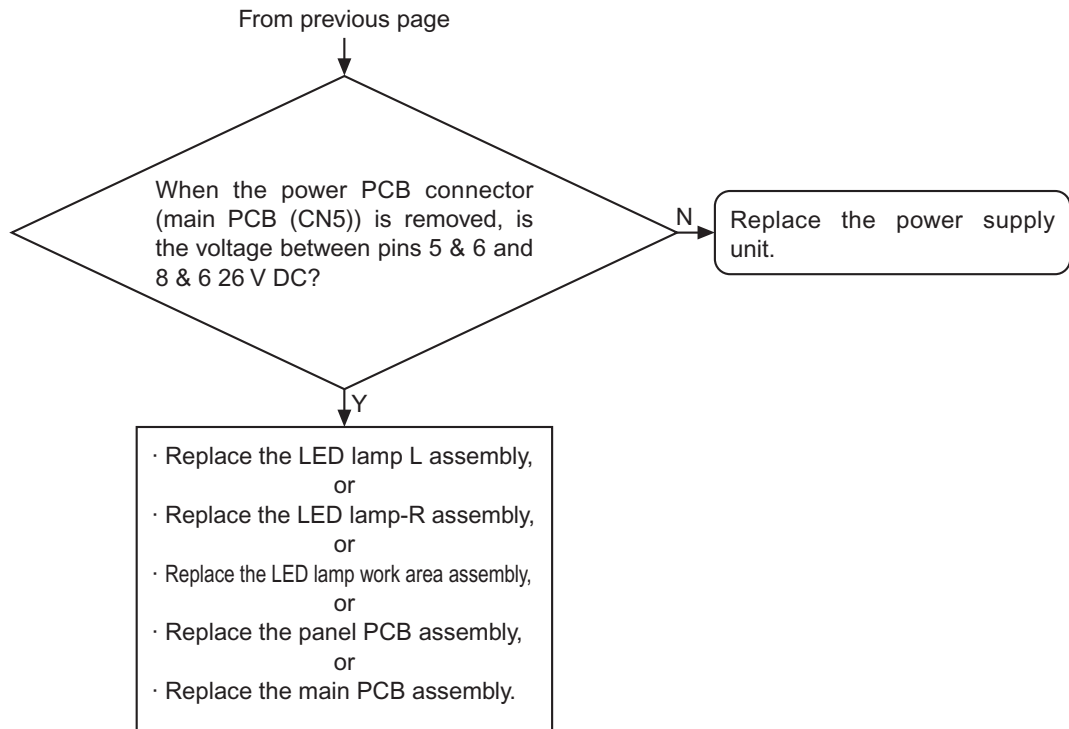



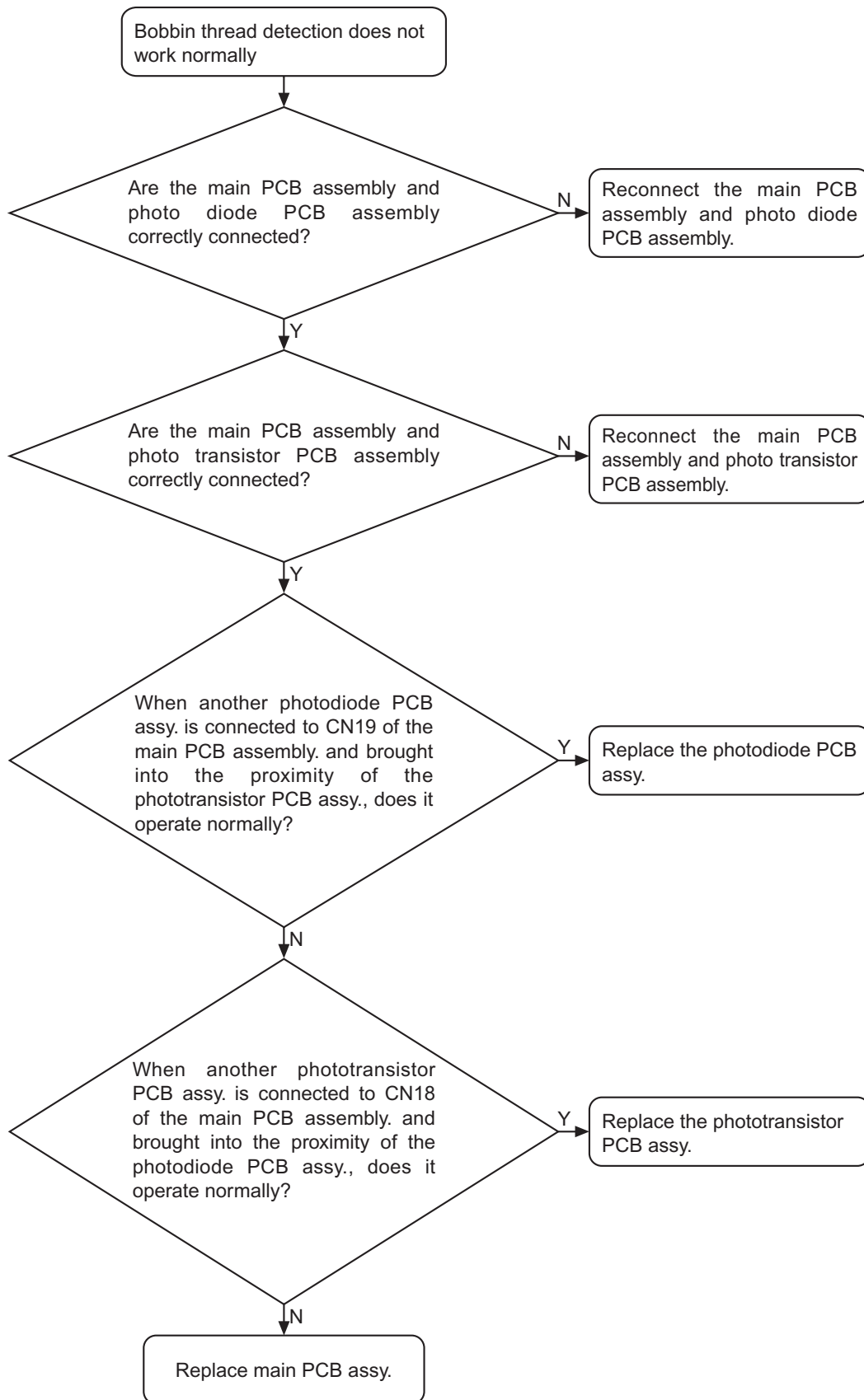

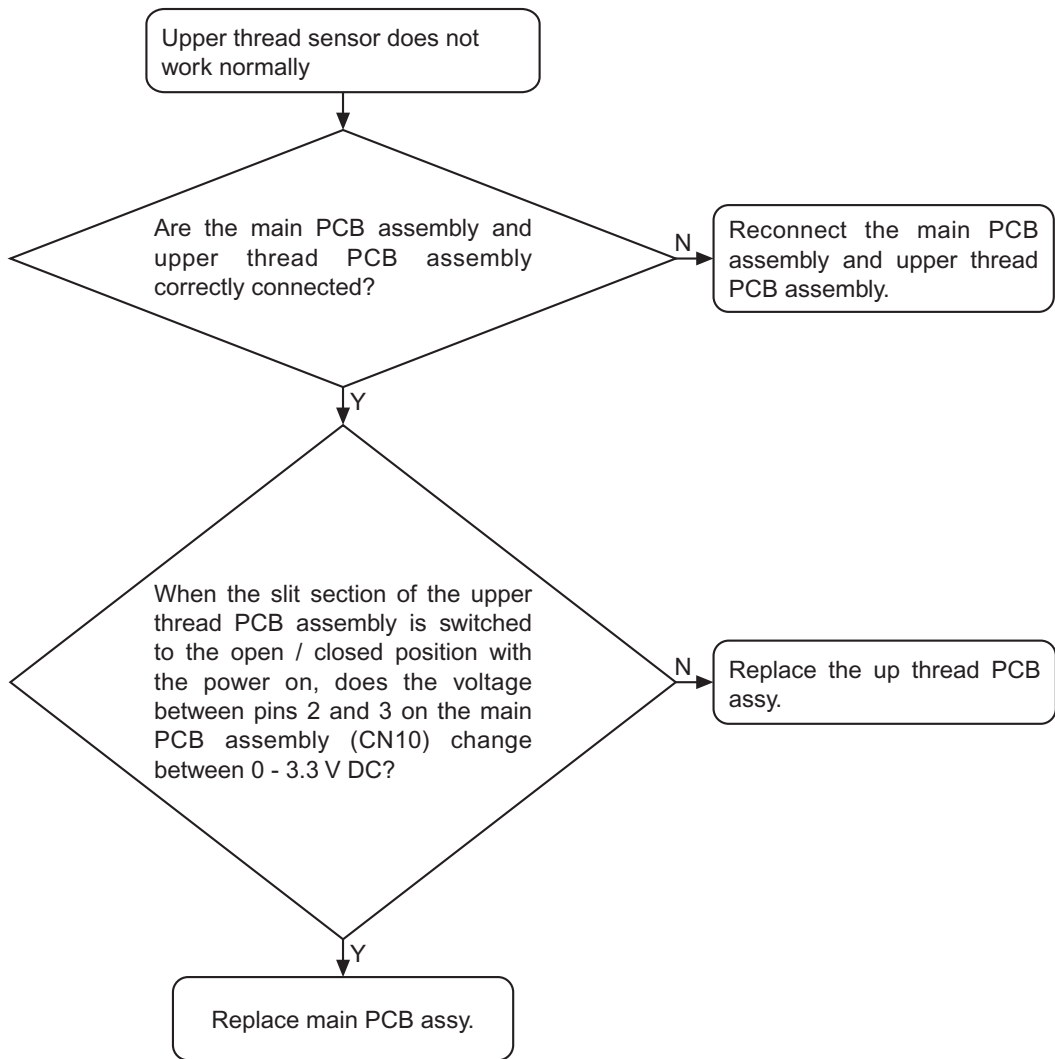

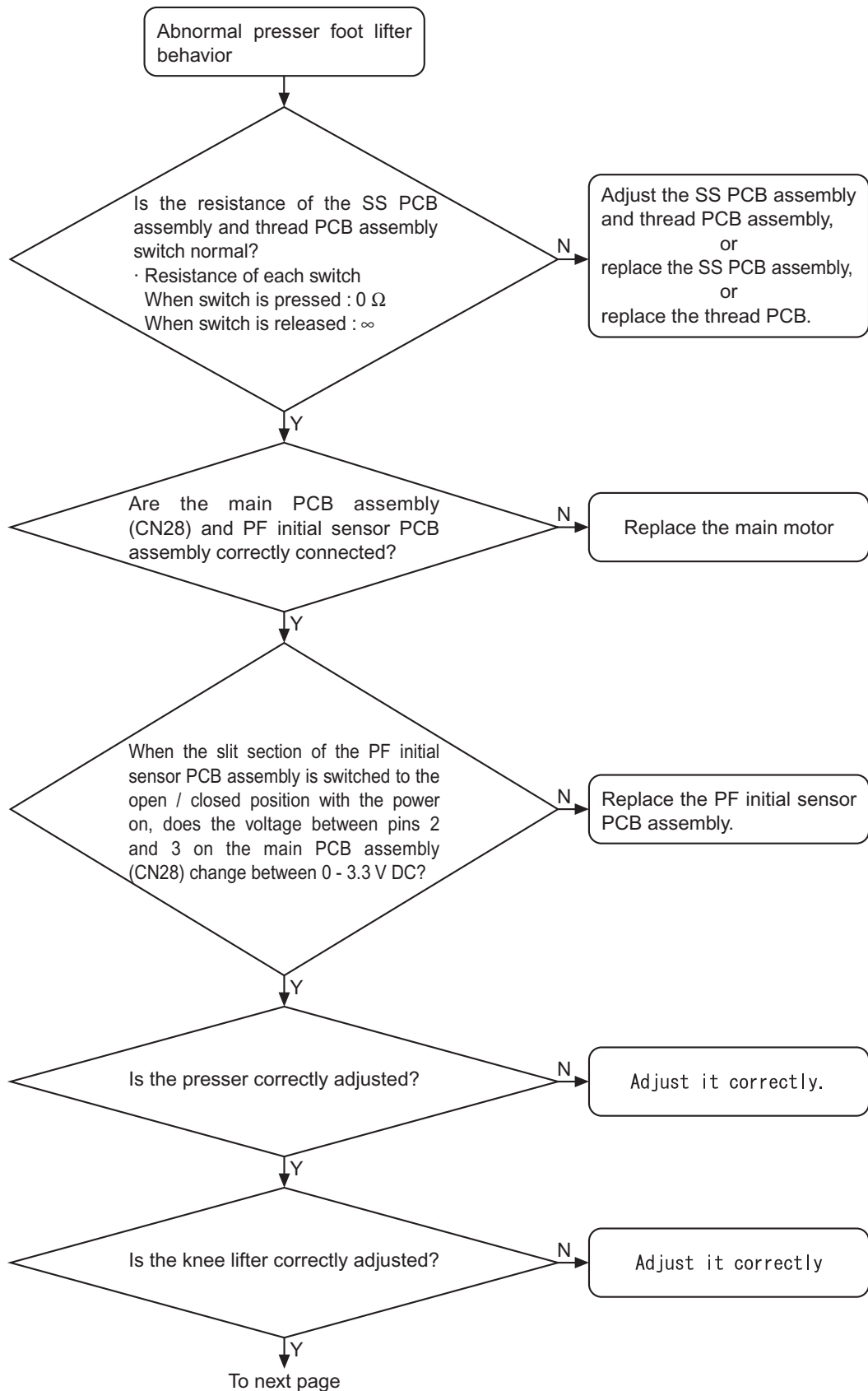

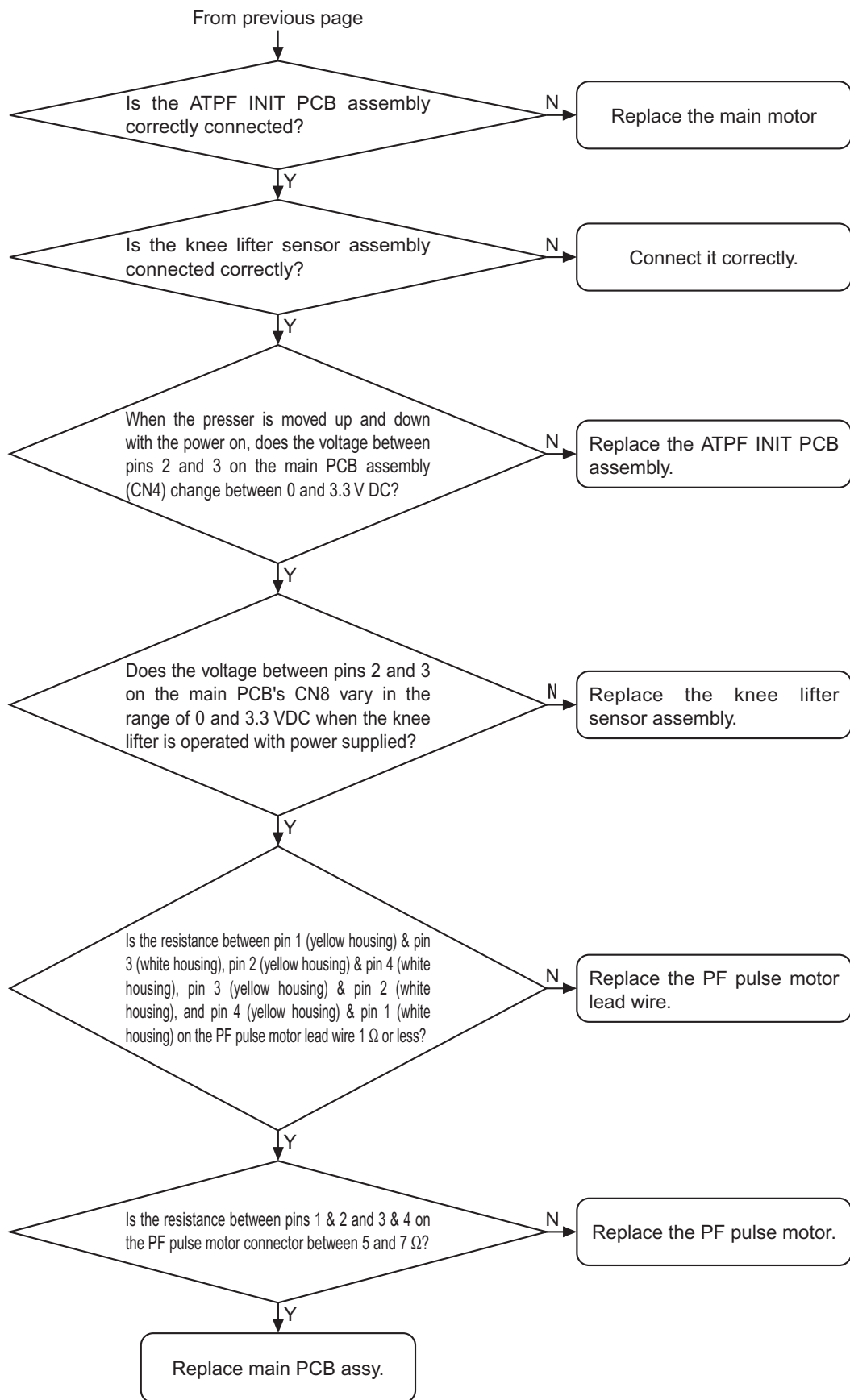

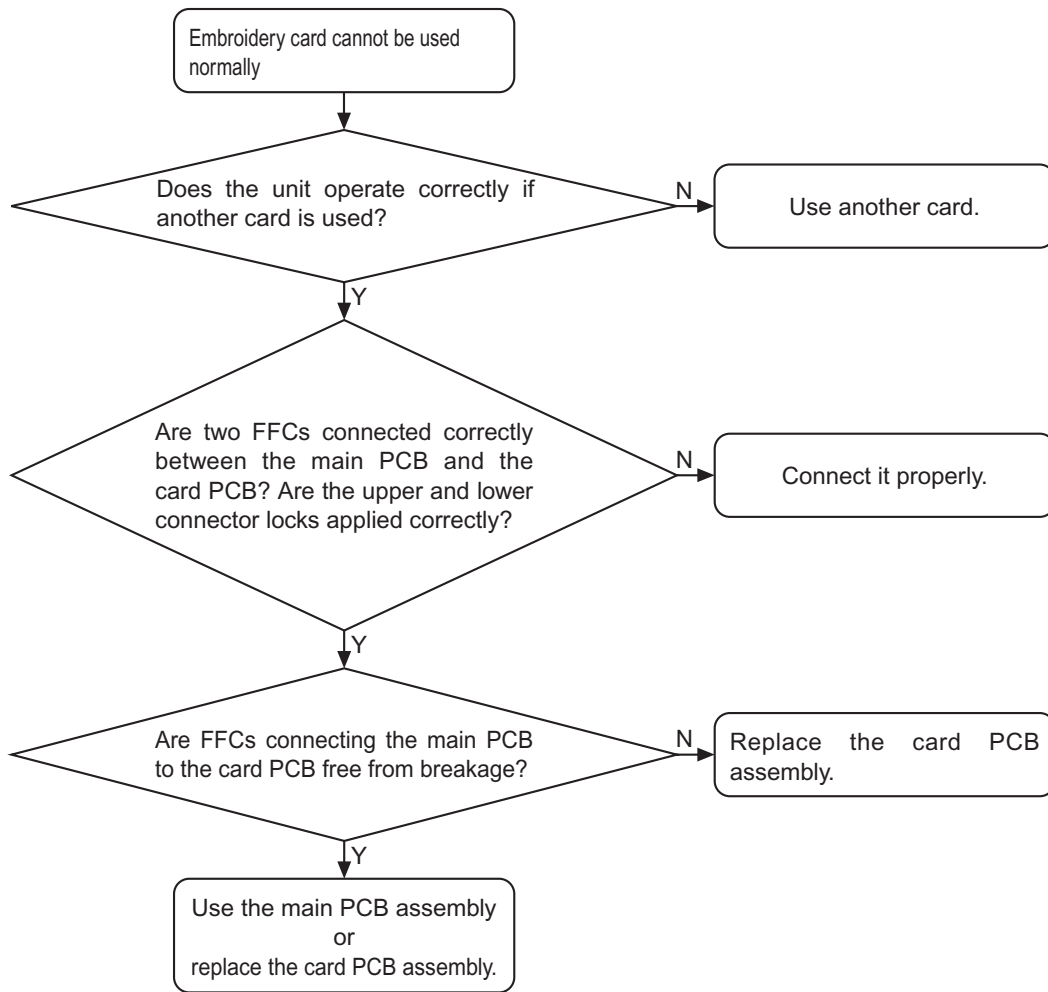

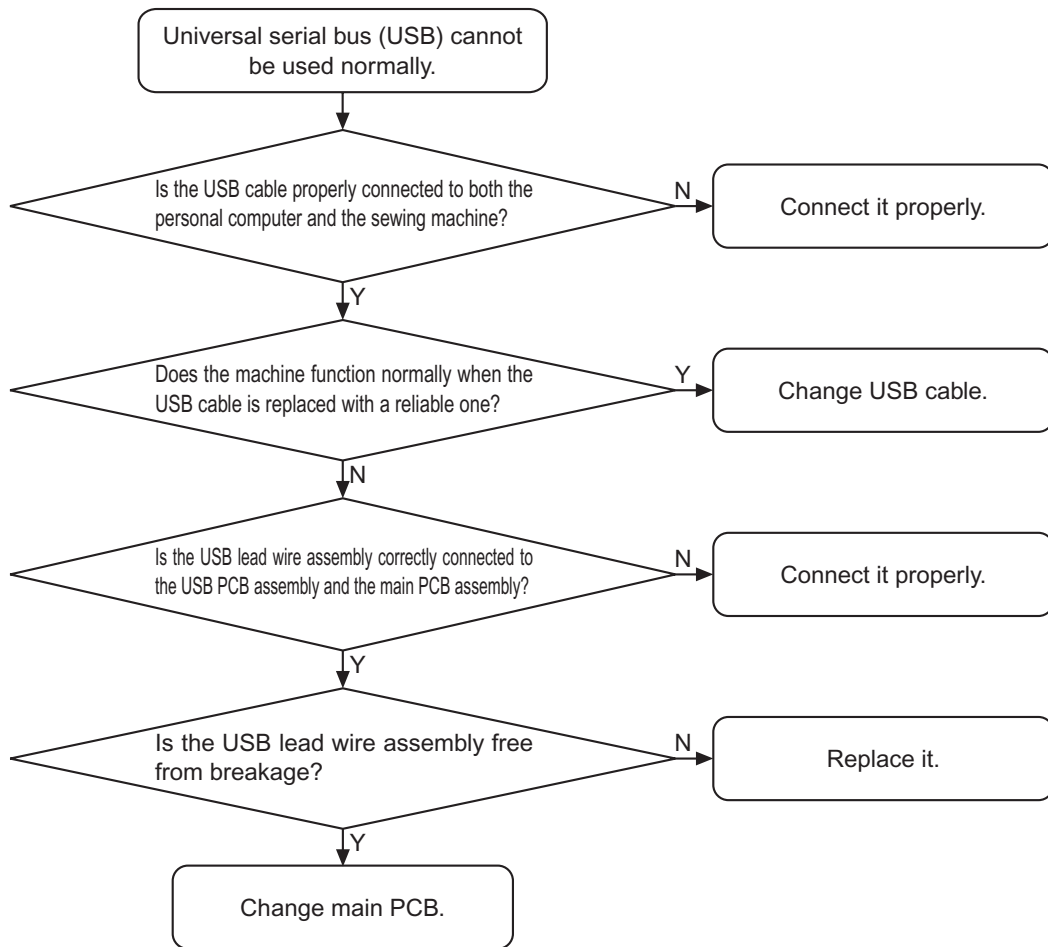



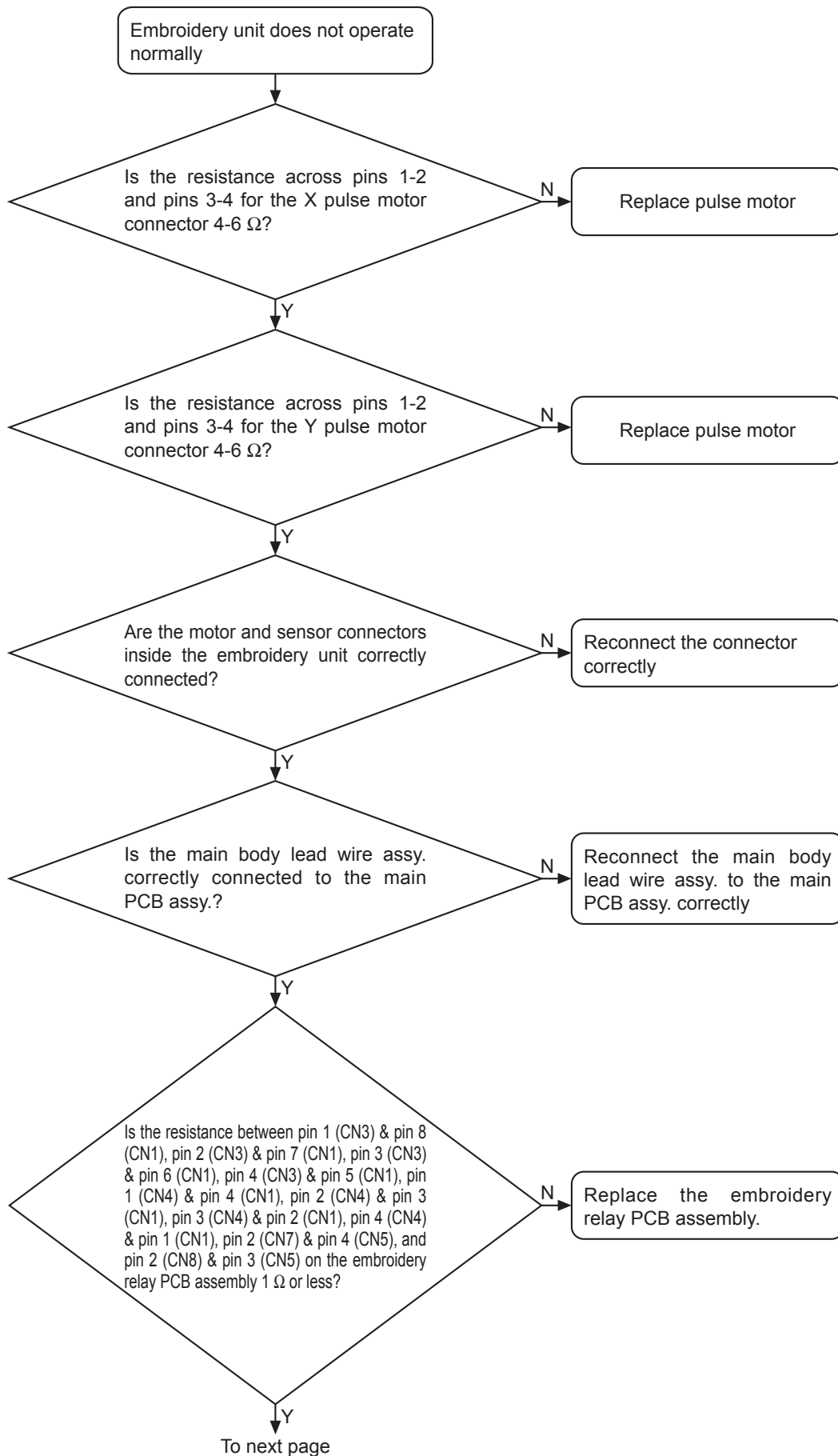

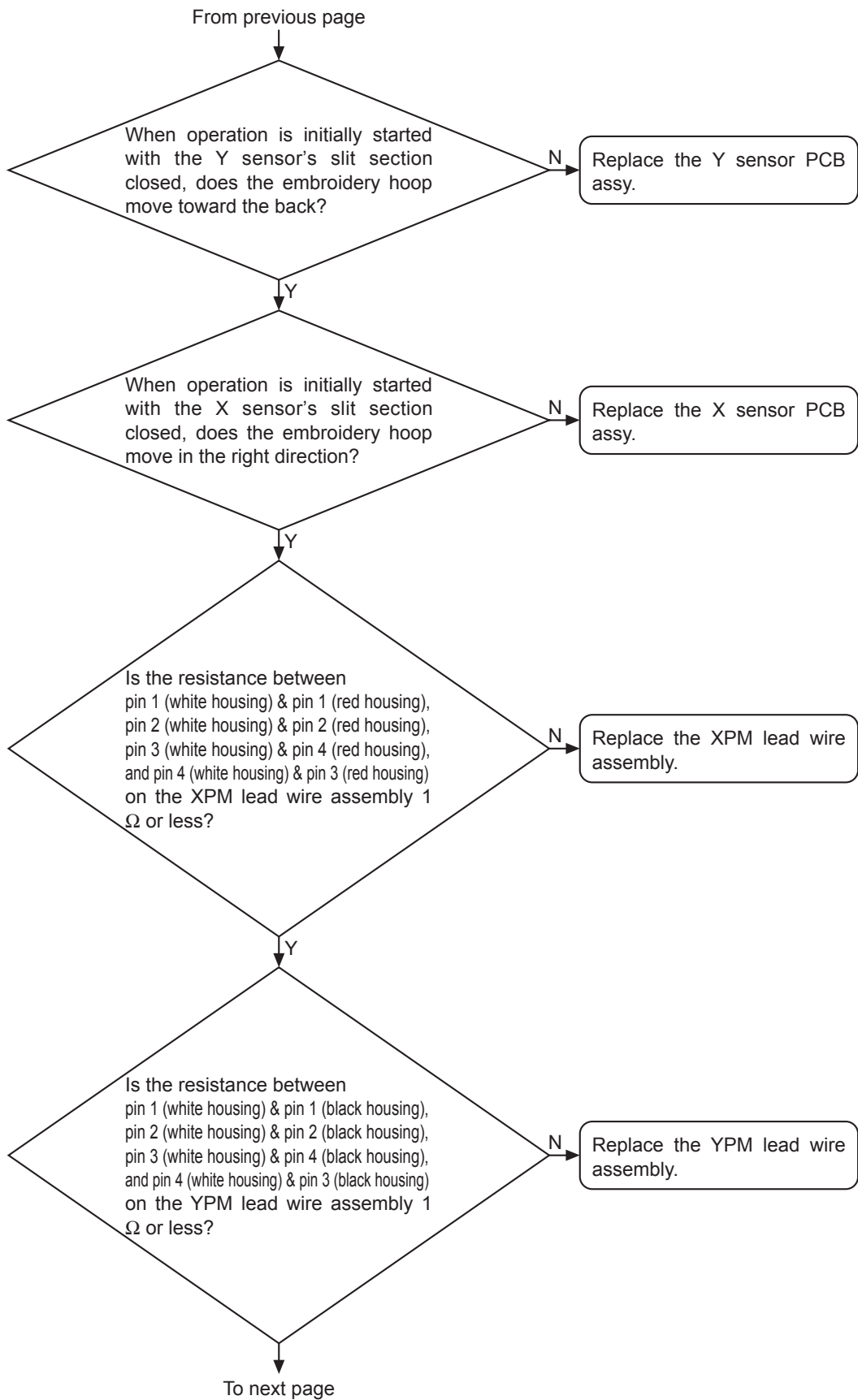

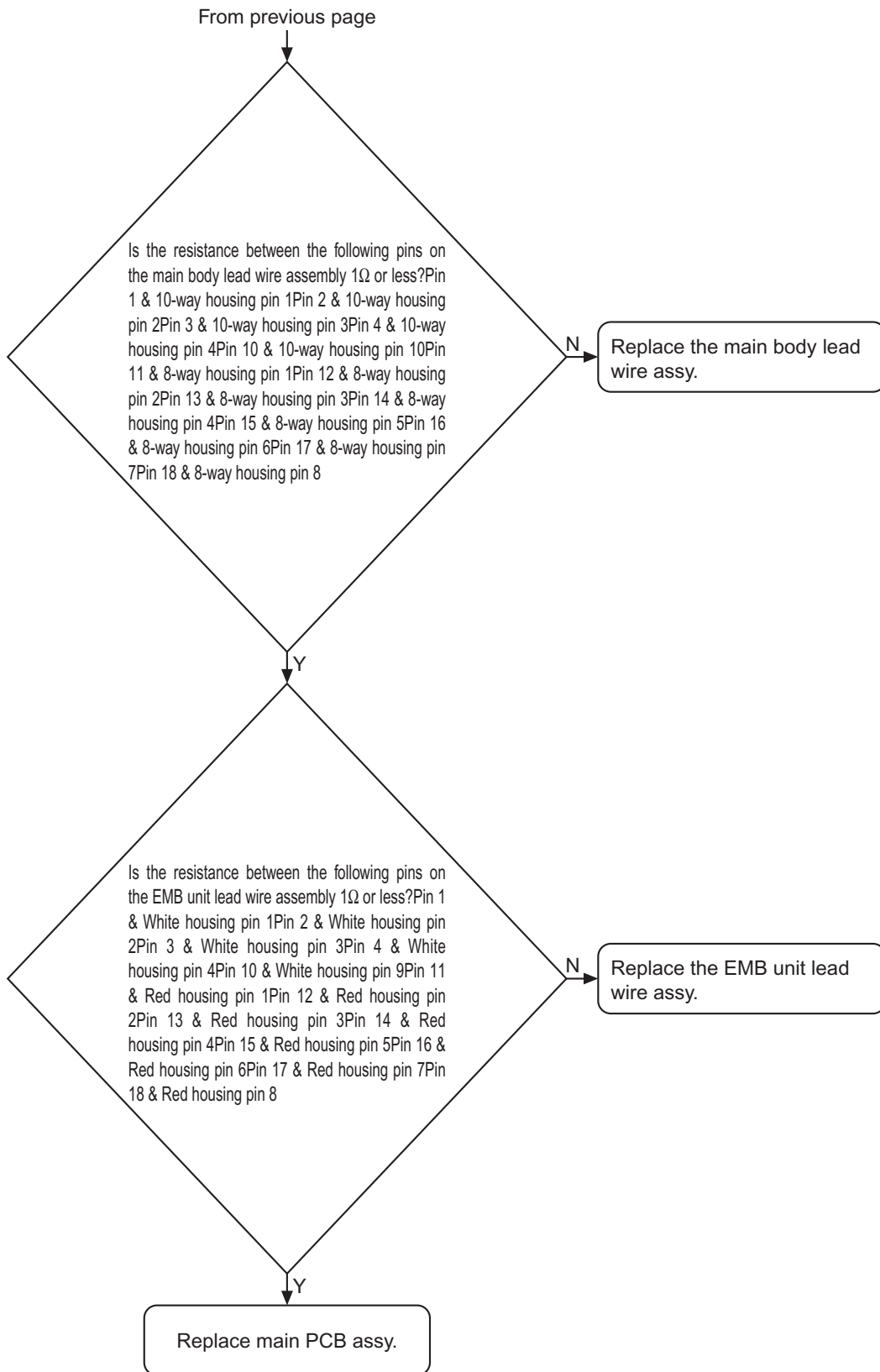

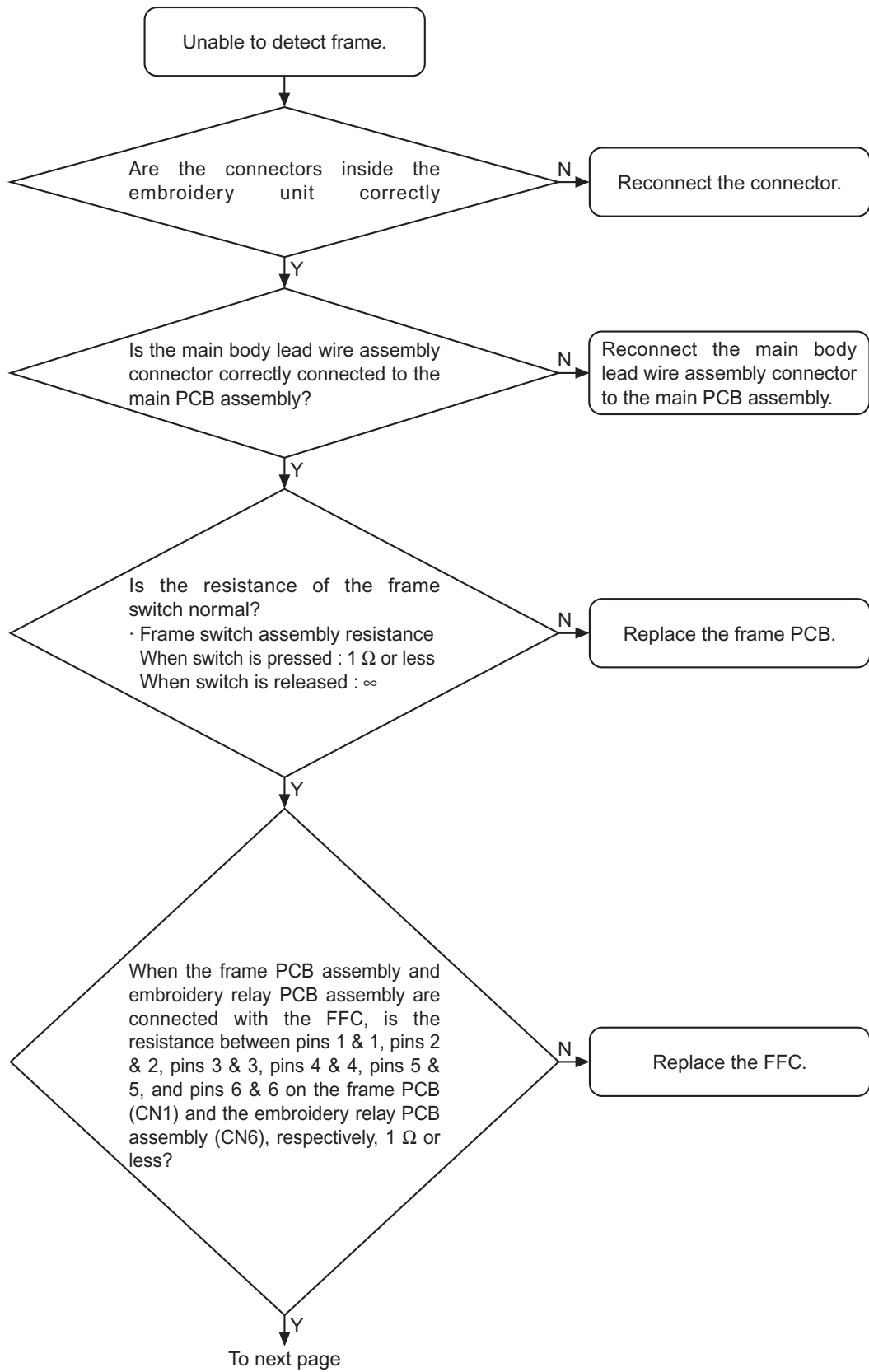

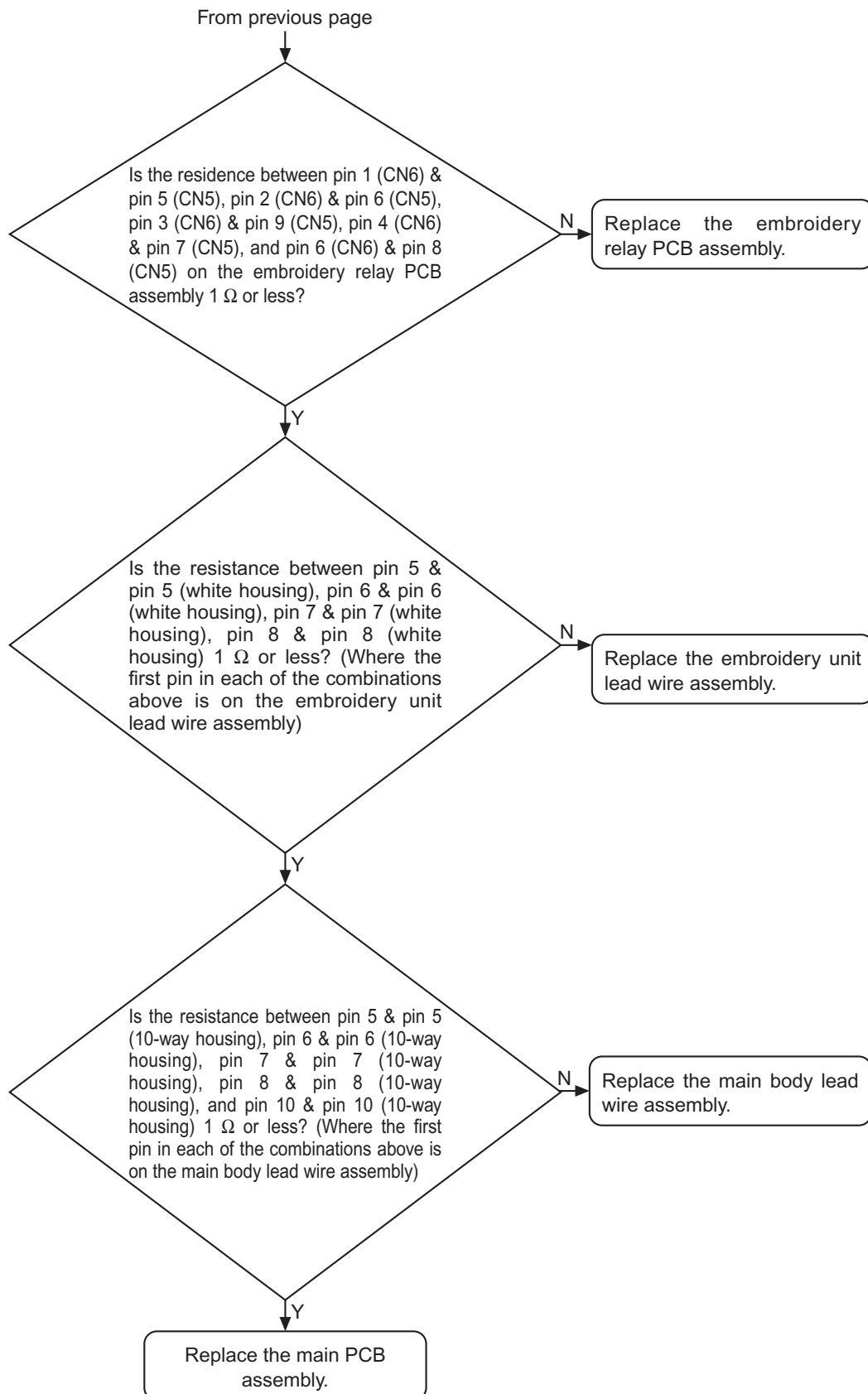

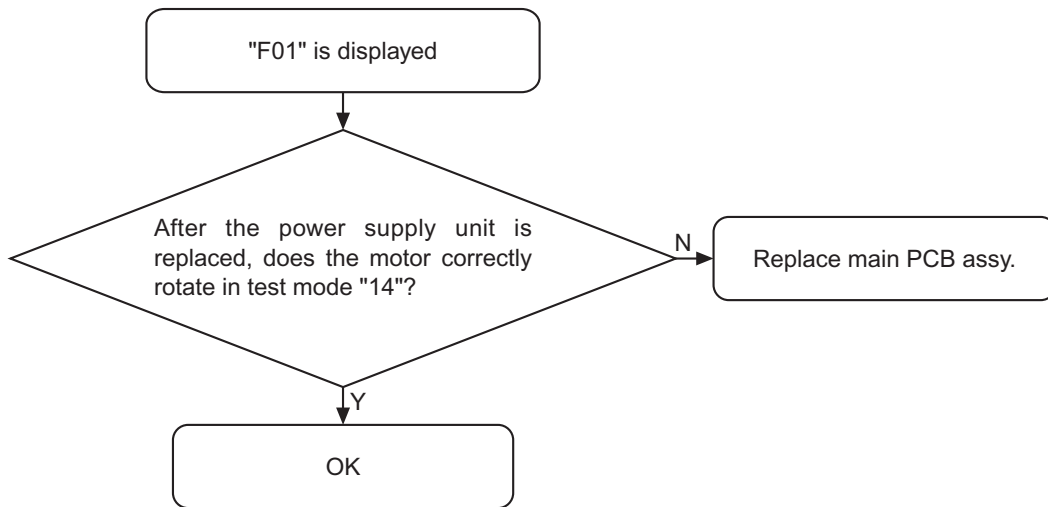



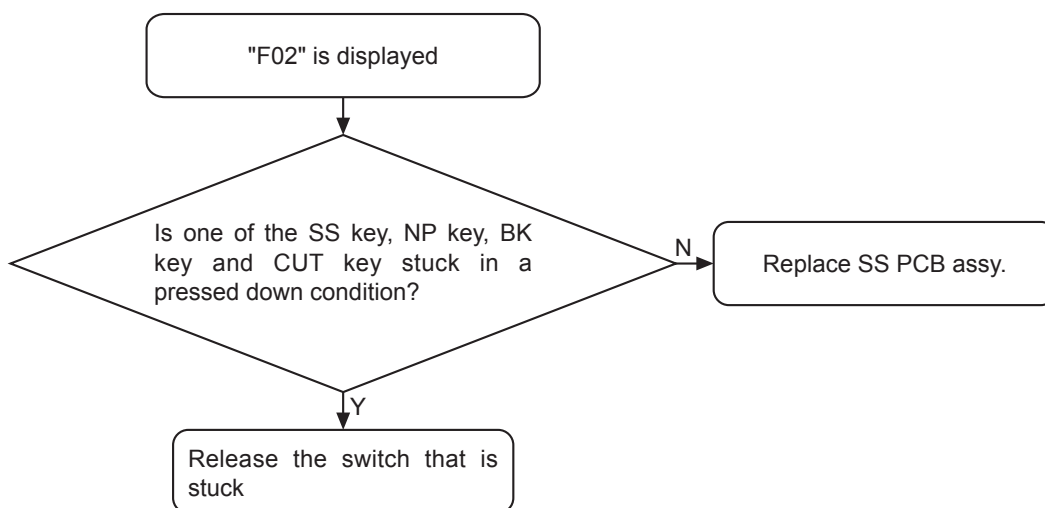

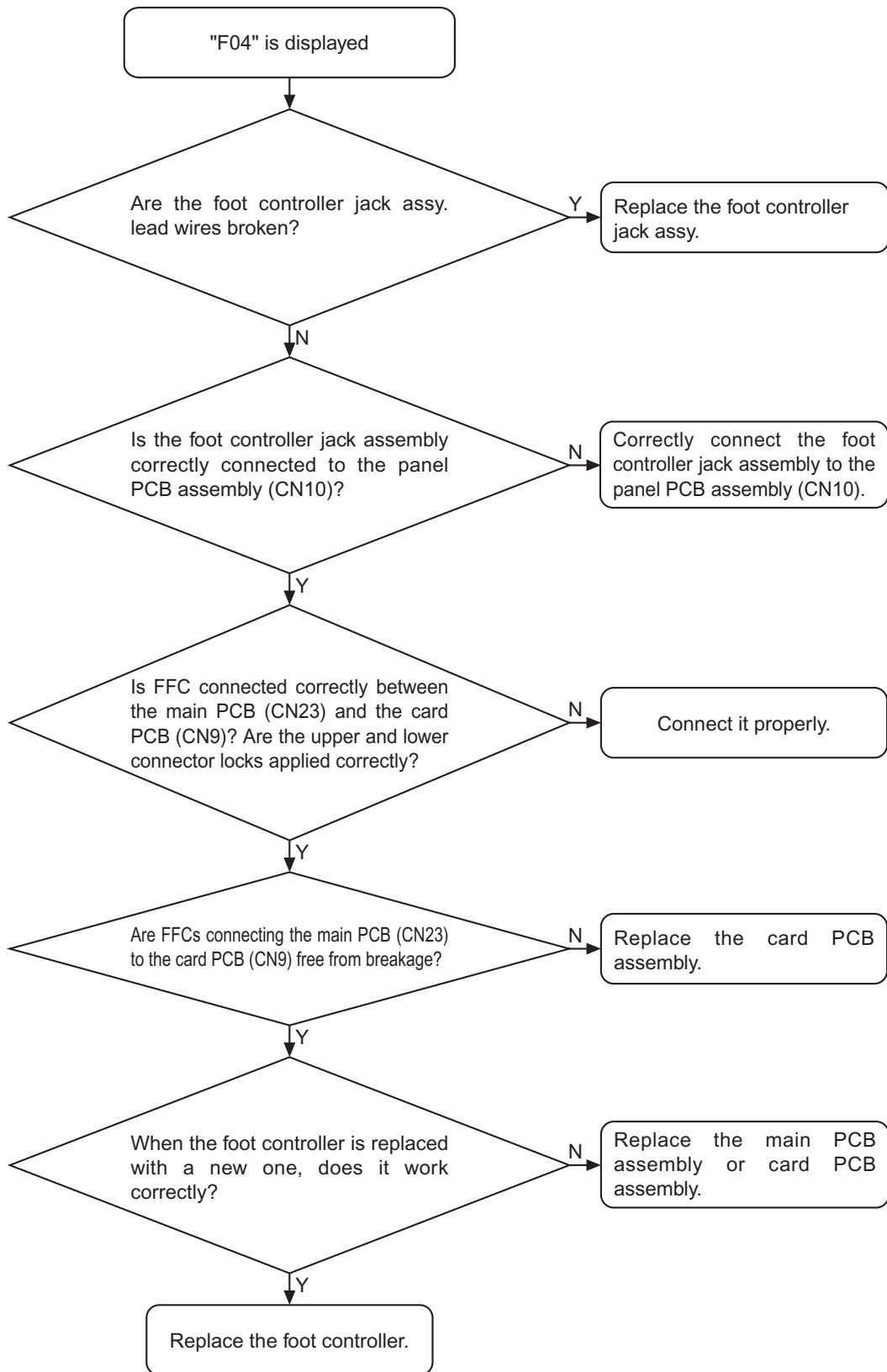

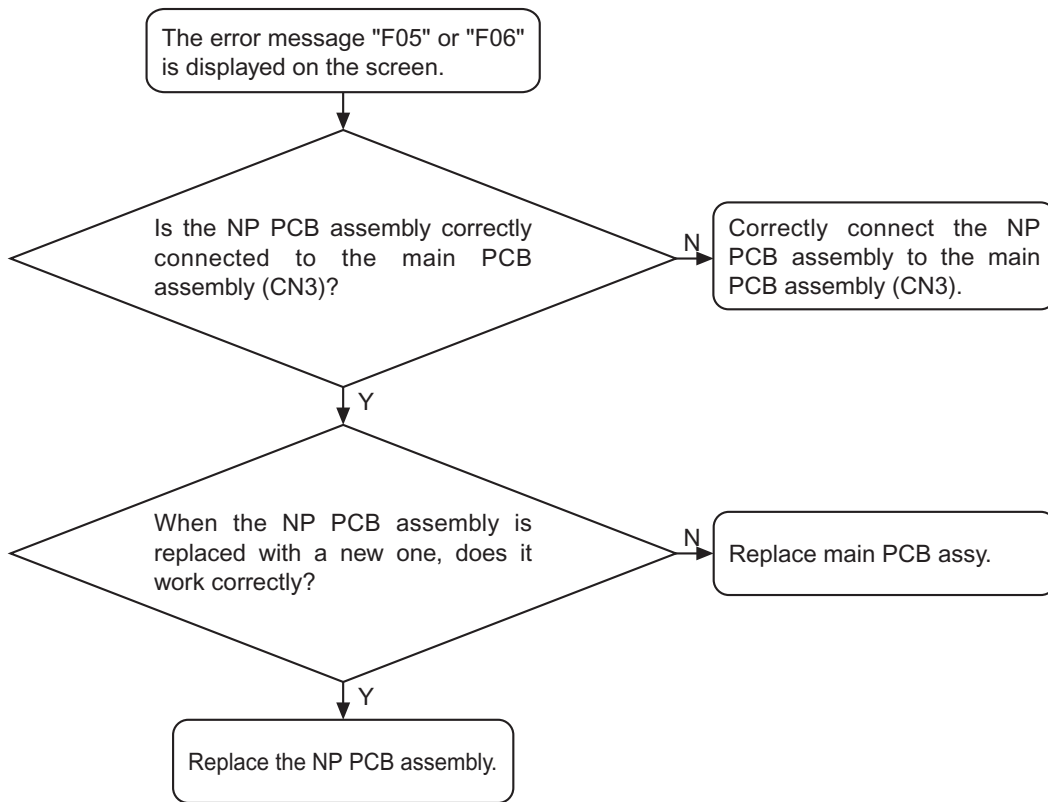

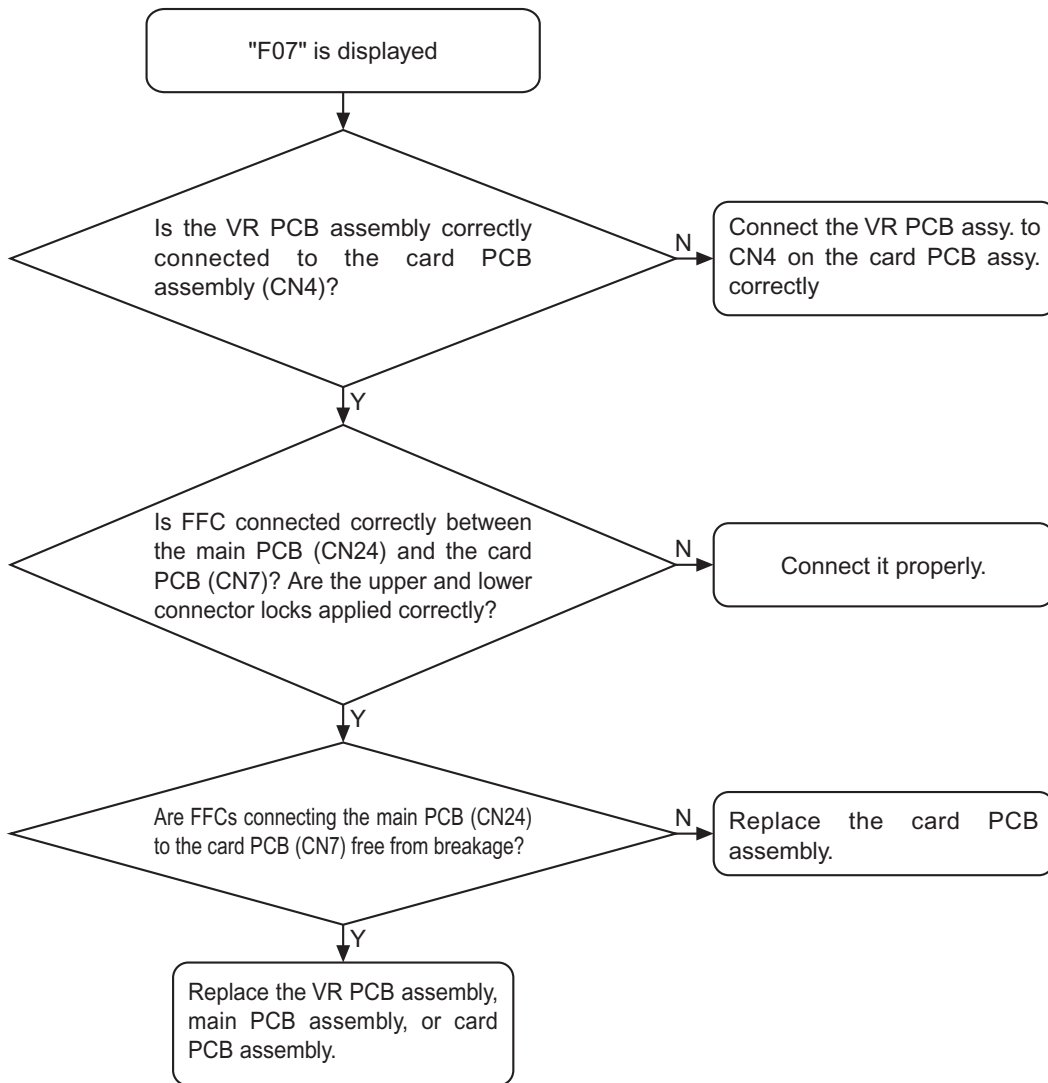

# 6 Special Instructions of Wiring

---

Needle bar module wiring .....	6 - 2
Rotary hook module wiring .....	6 - 6
Thread cutter module wiring .....	6 - 7
Main PCB wiring .....	6 - 8
Front cover wiring .....	6 - 11
Bobbin winder unit wiring .....	6 - 12

1. Wiring on left side of needle-presser module

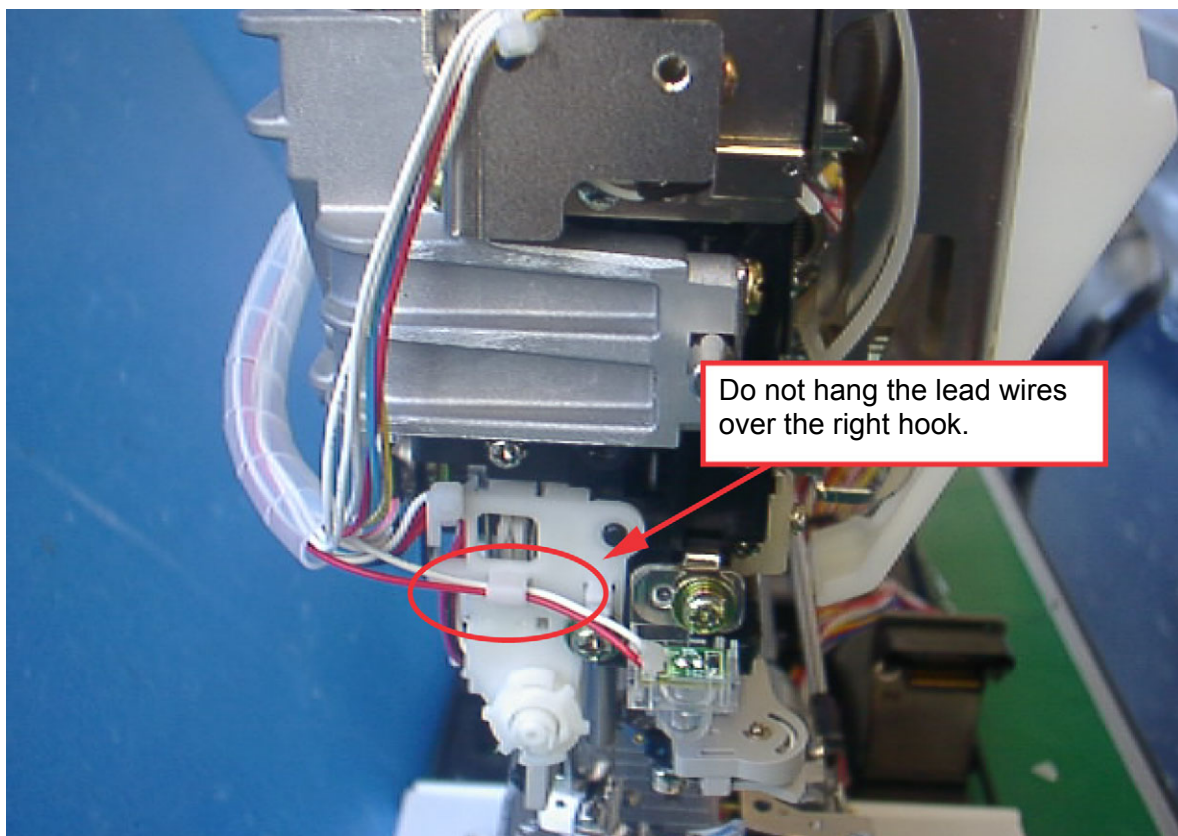

2. Wiring on upper side of needle-presser module

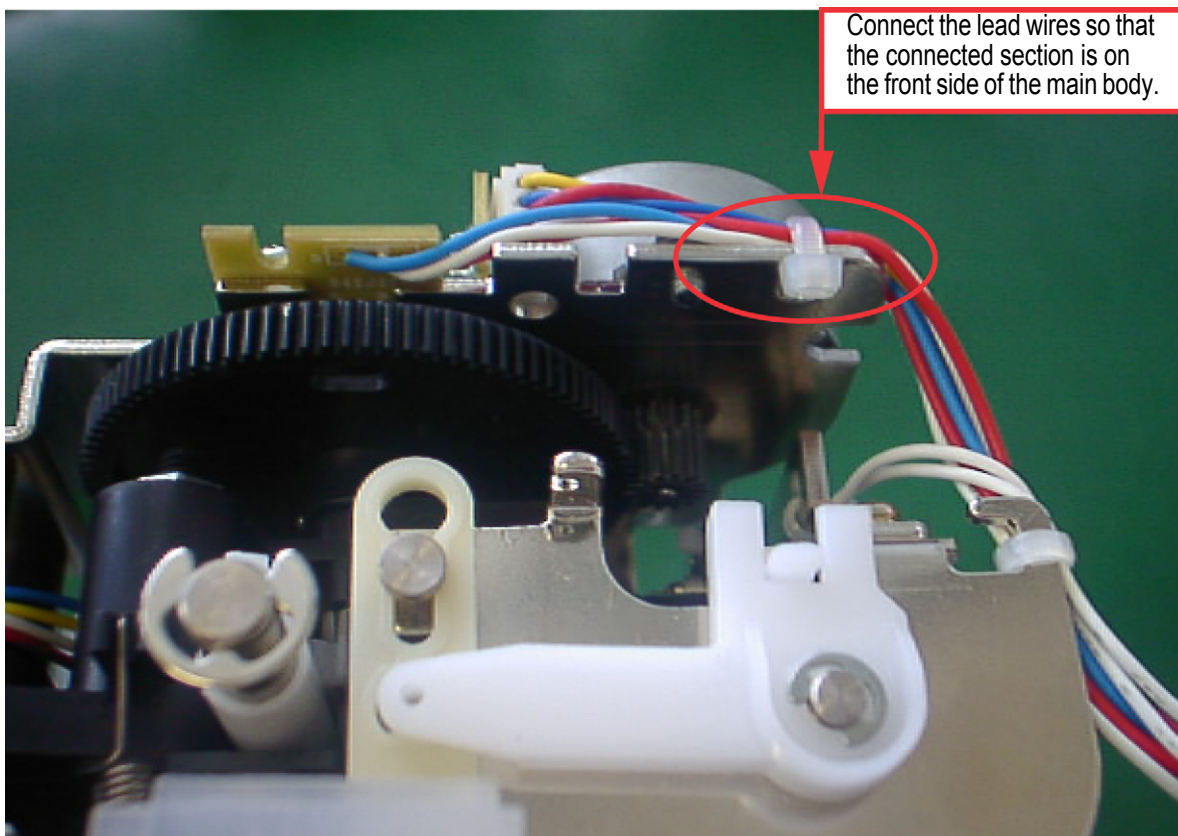



3. Wiring on right side of needle-presser module

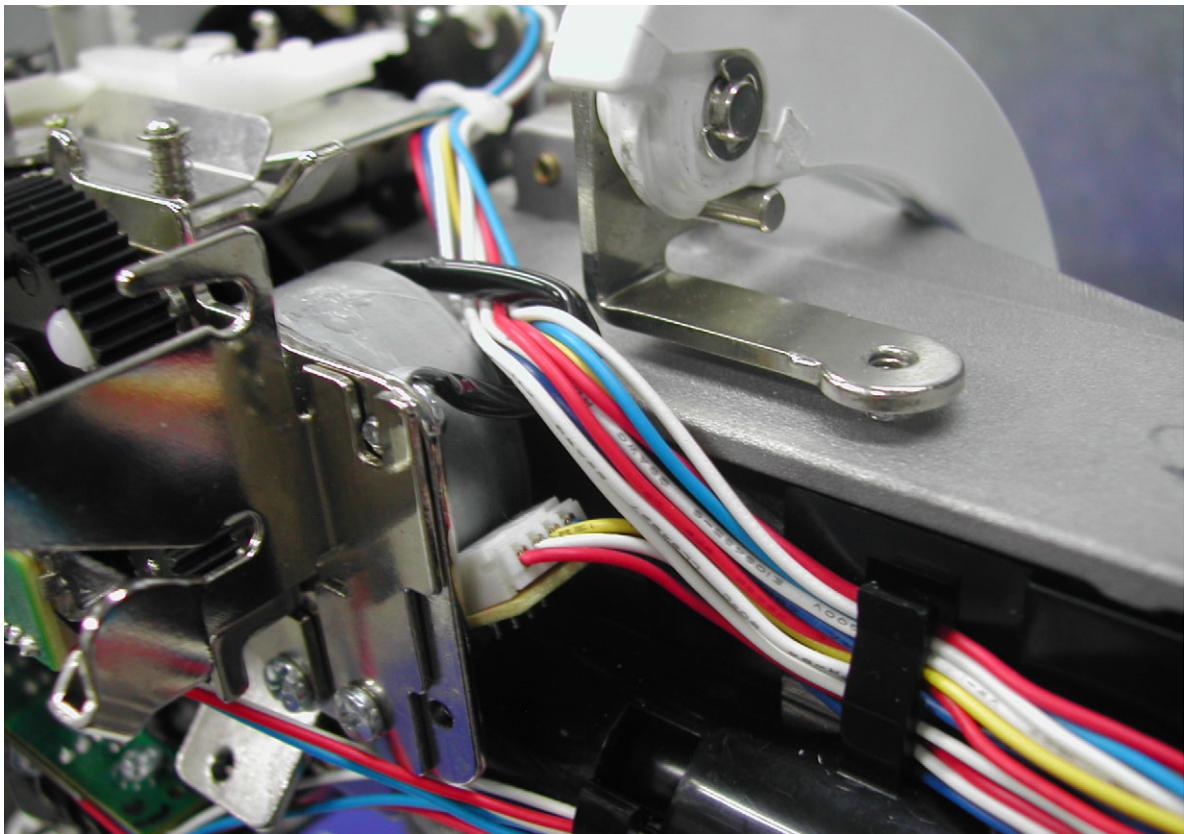

4. Wiring on lower side of needle-presser module

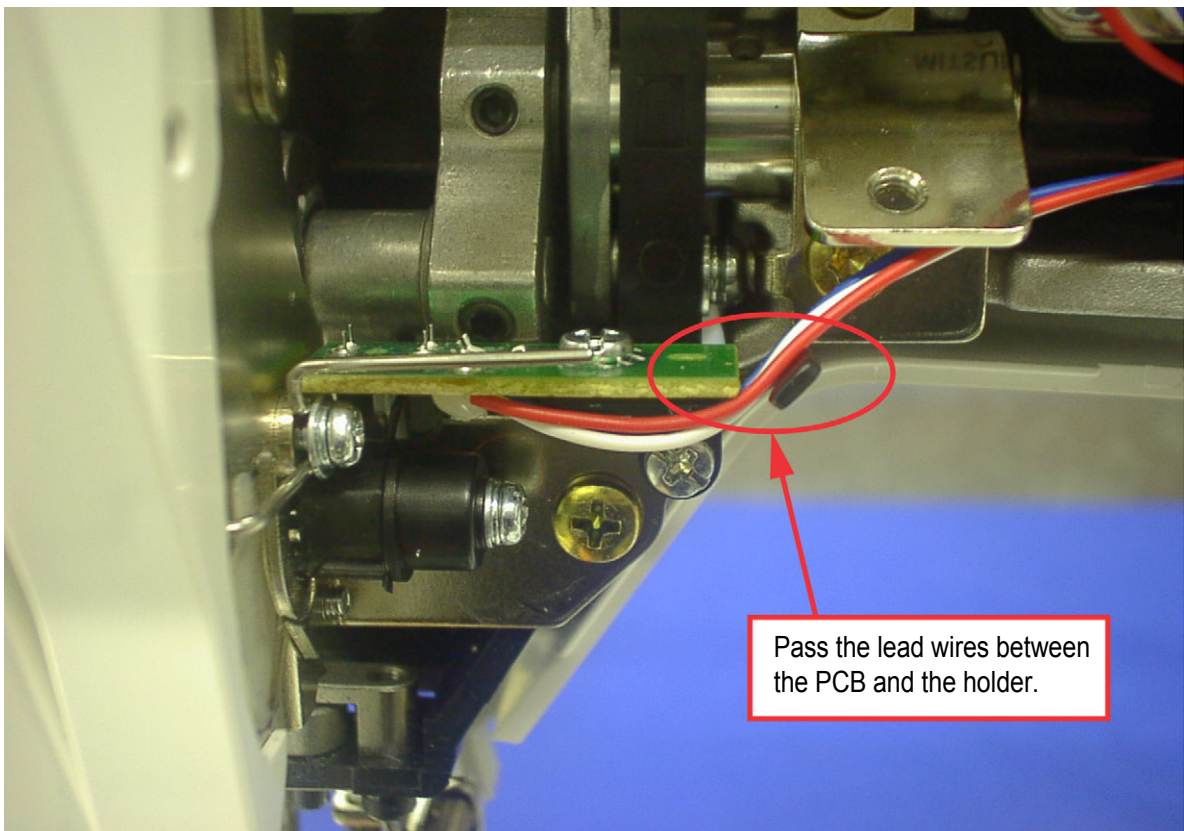



5. Wiring around upper shaft cover

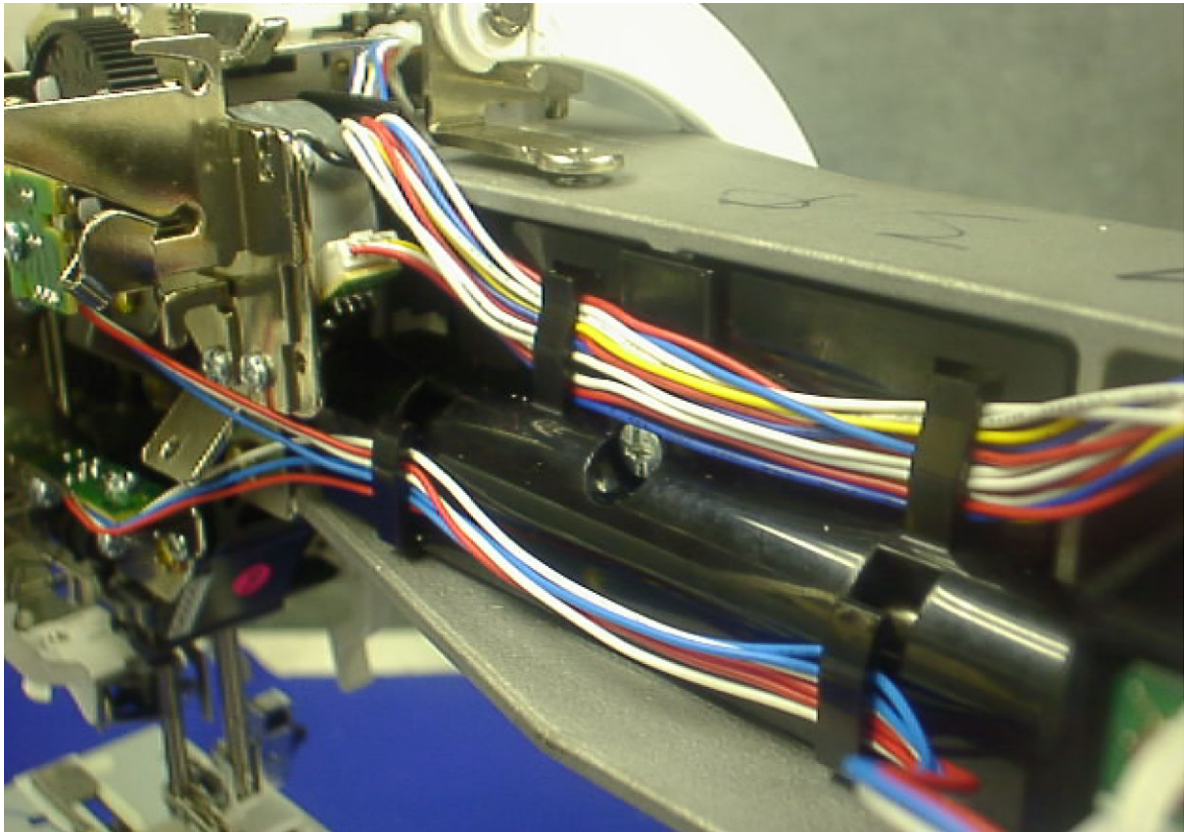

6. Wiring of NP sensor

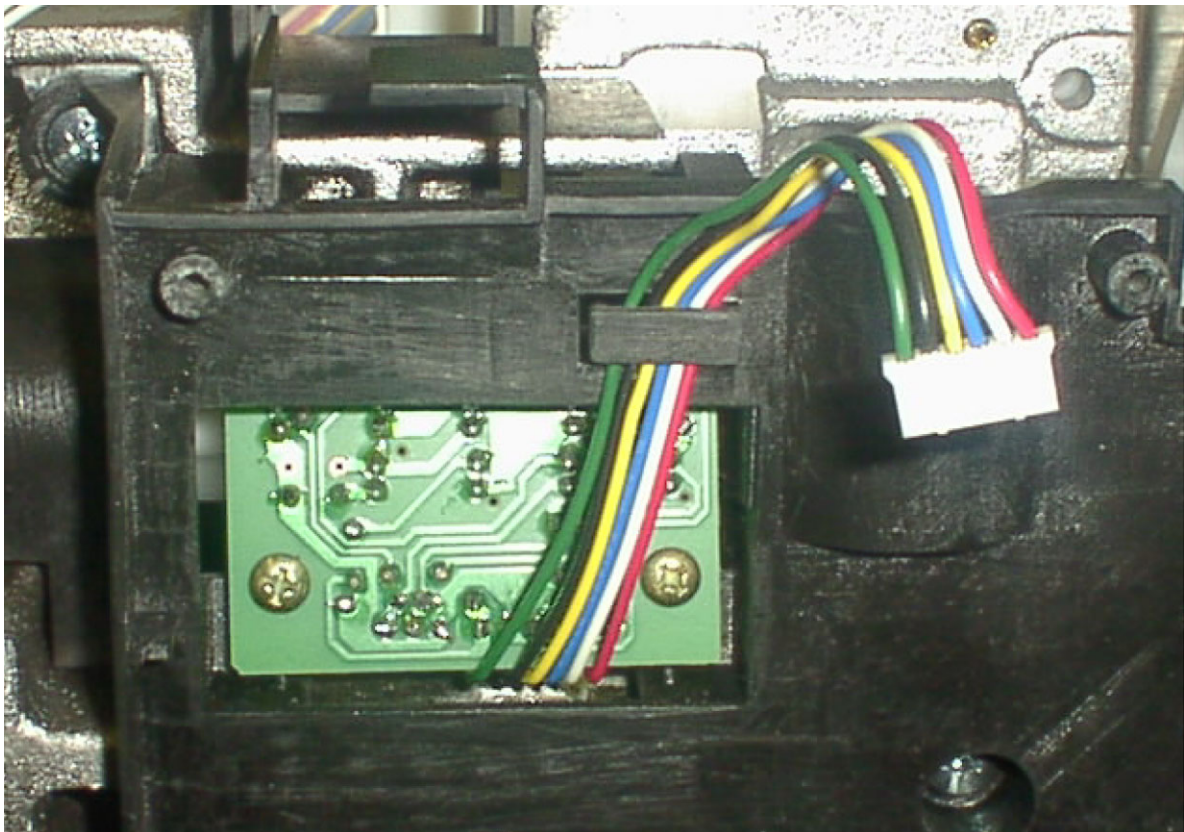



7. Wiring on backside of arm bed

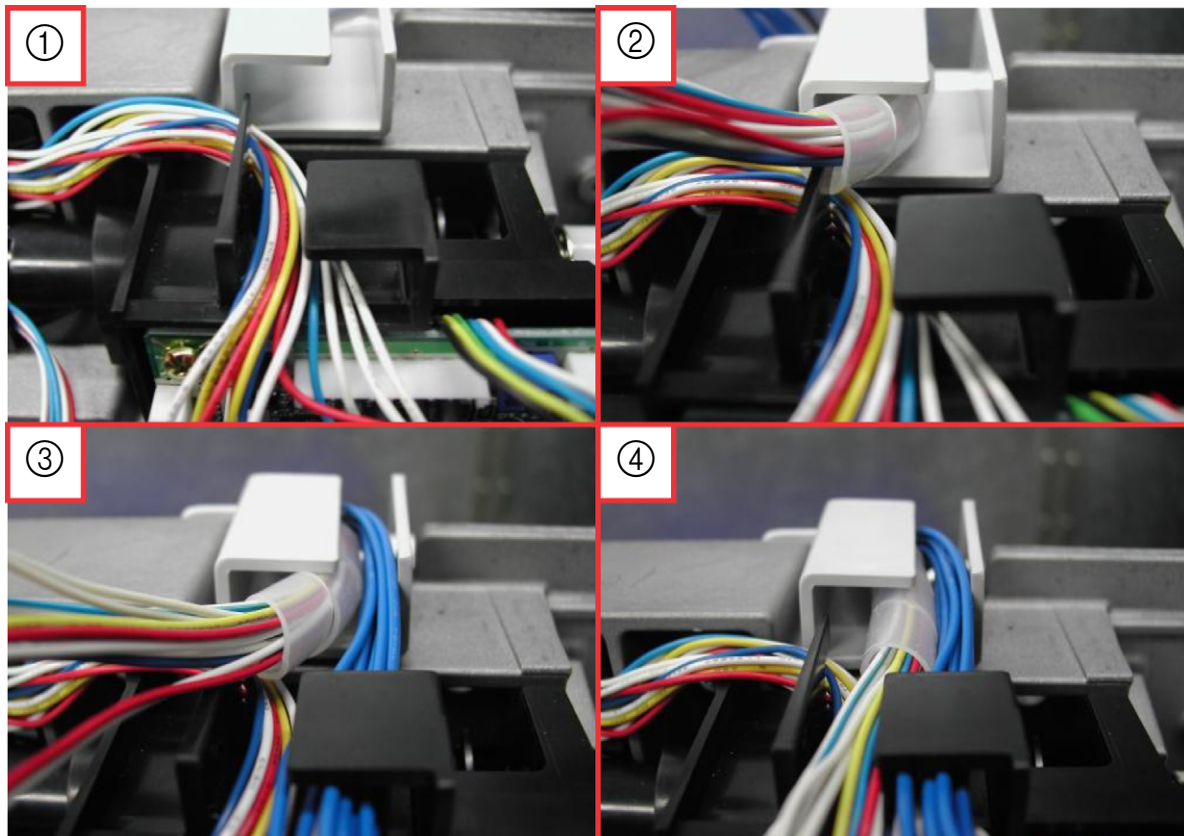
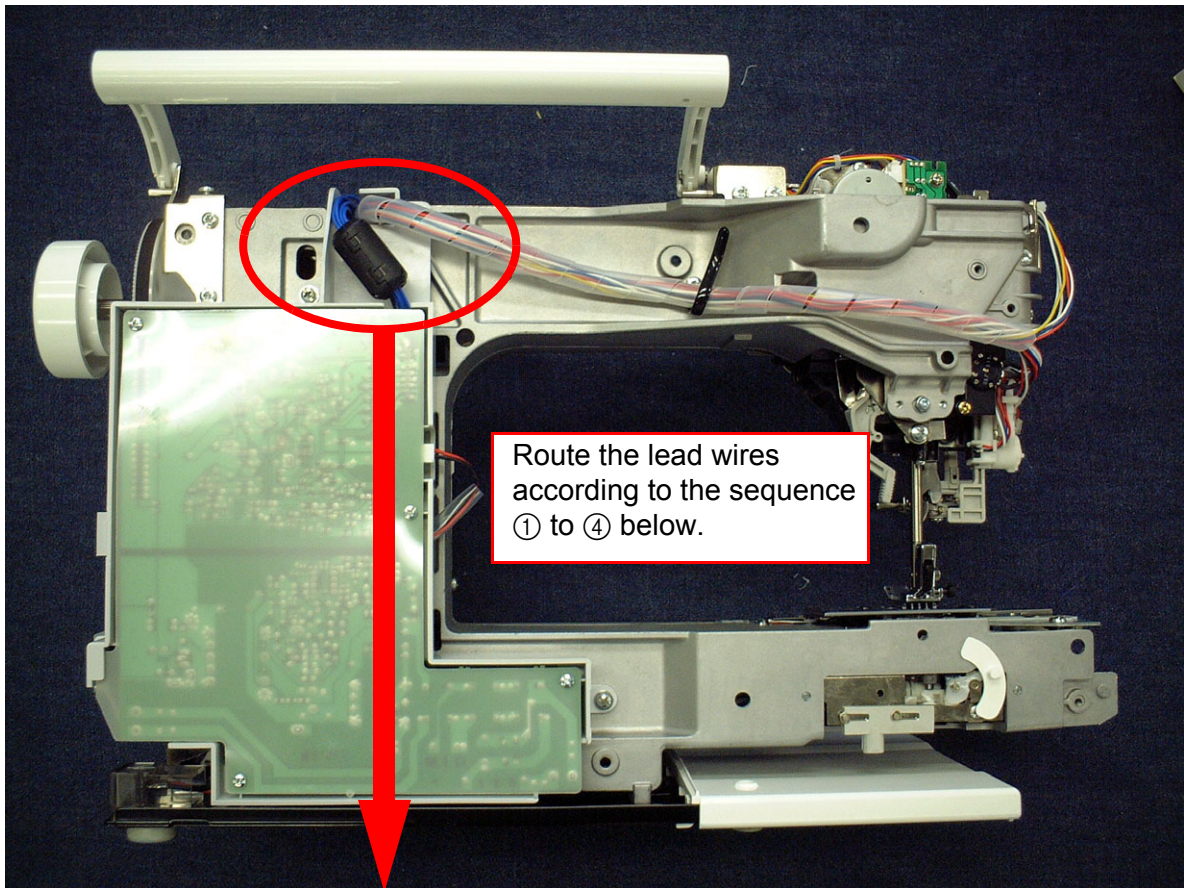



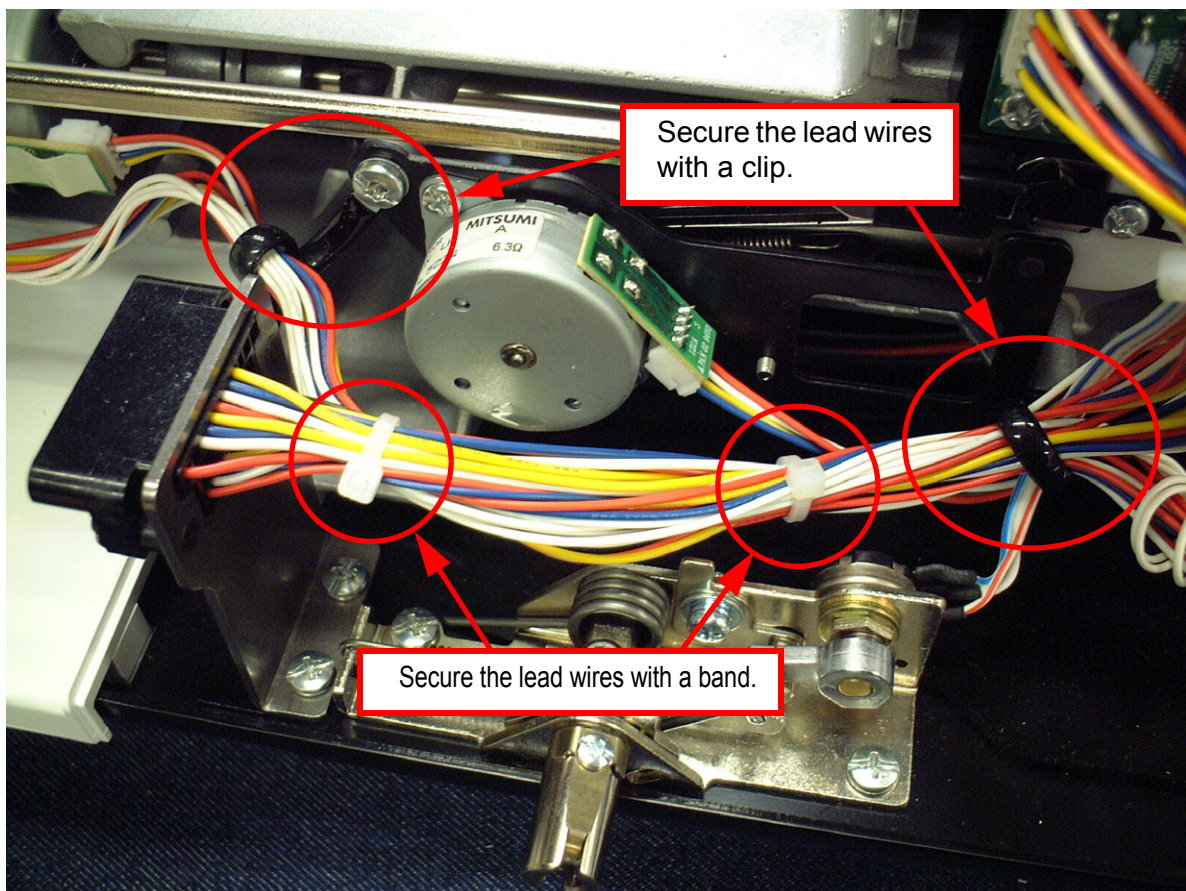
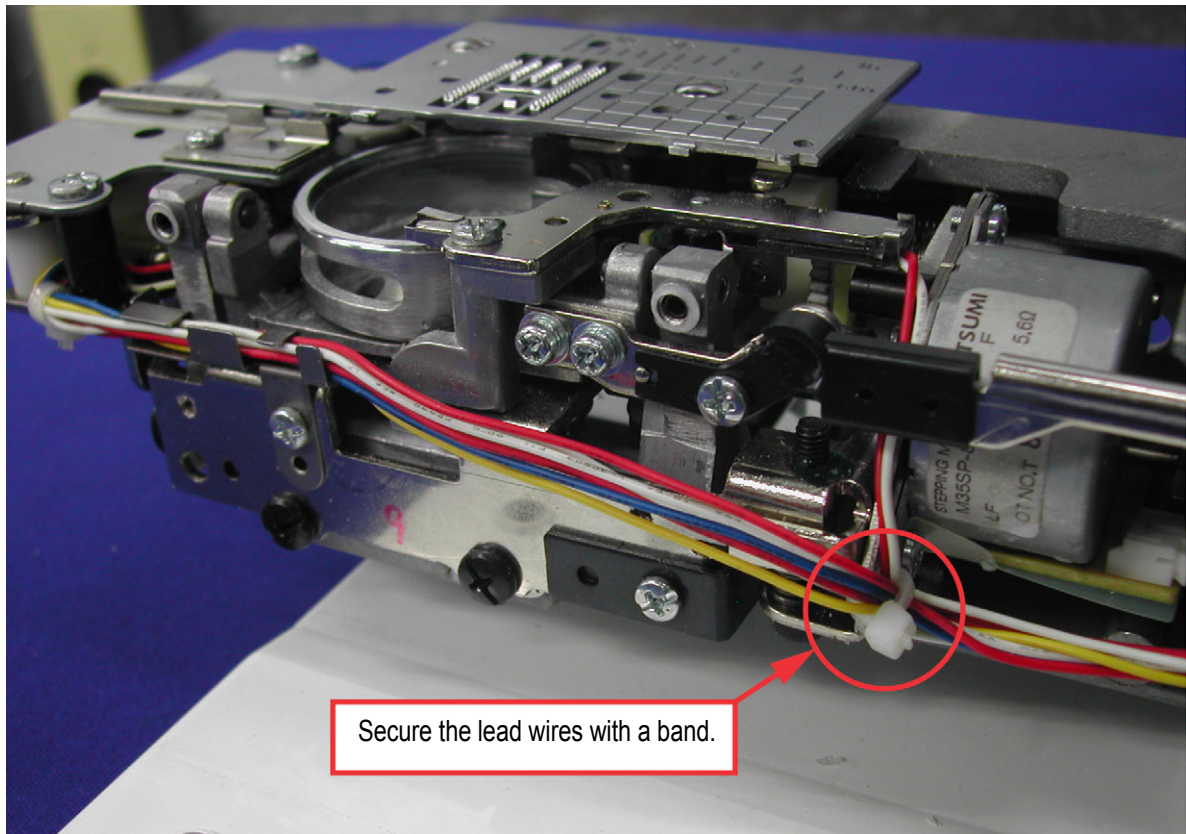



1. Wiring on backside of thread-cutter module

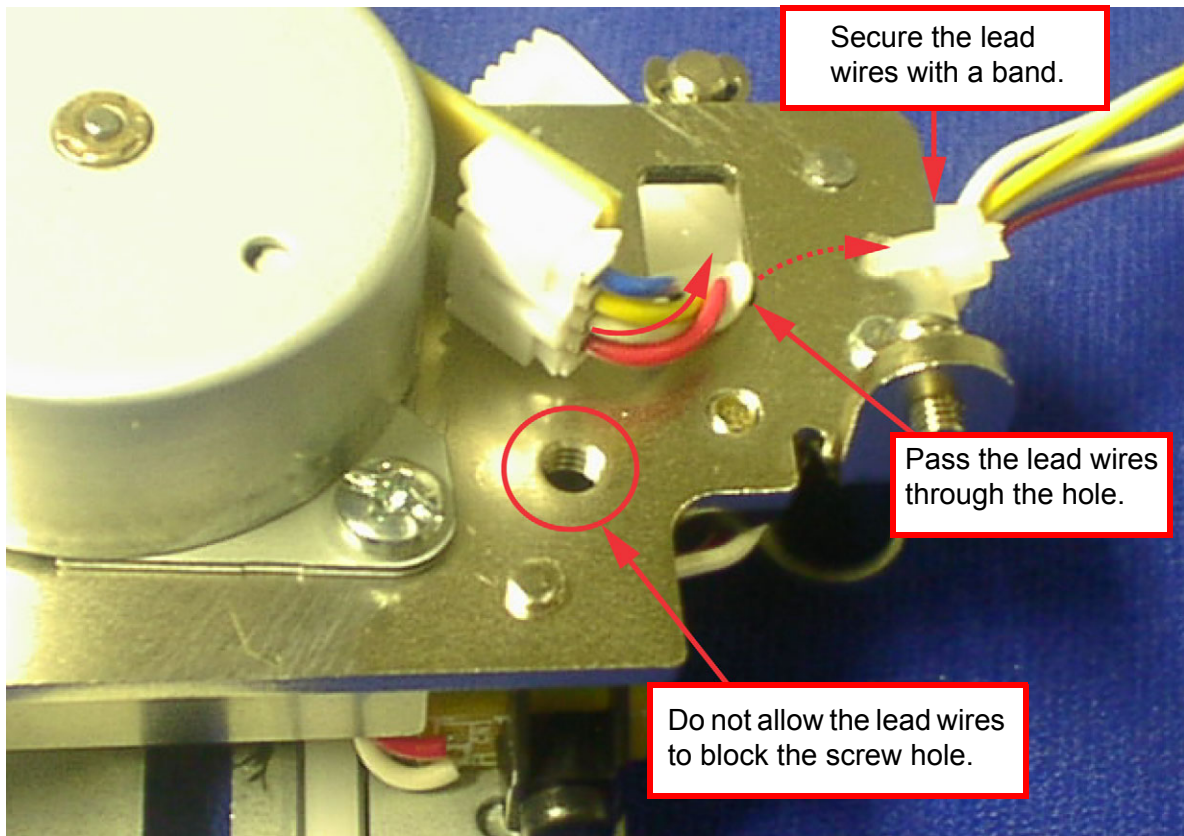

2. Wiring on front side of thread-cutter module

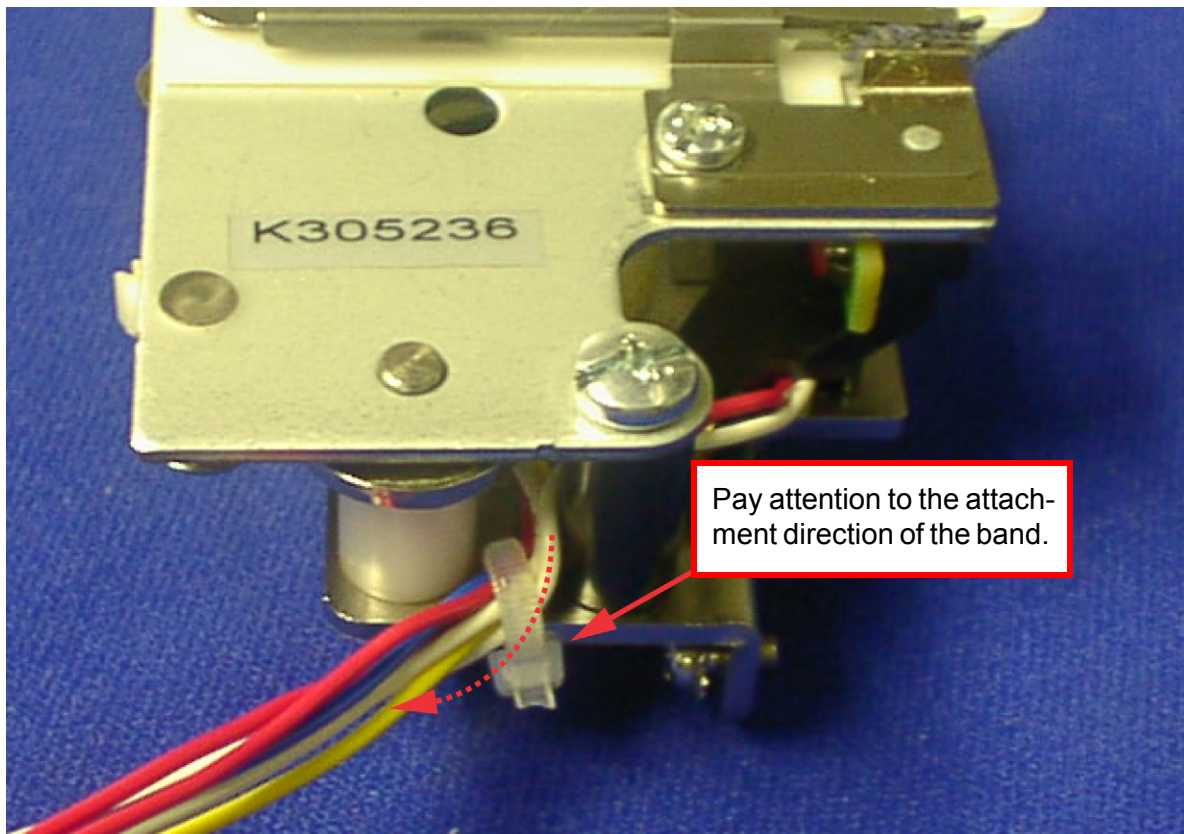



1. Wiring at upper section of main PCB

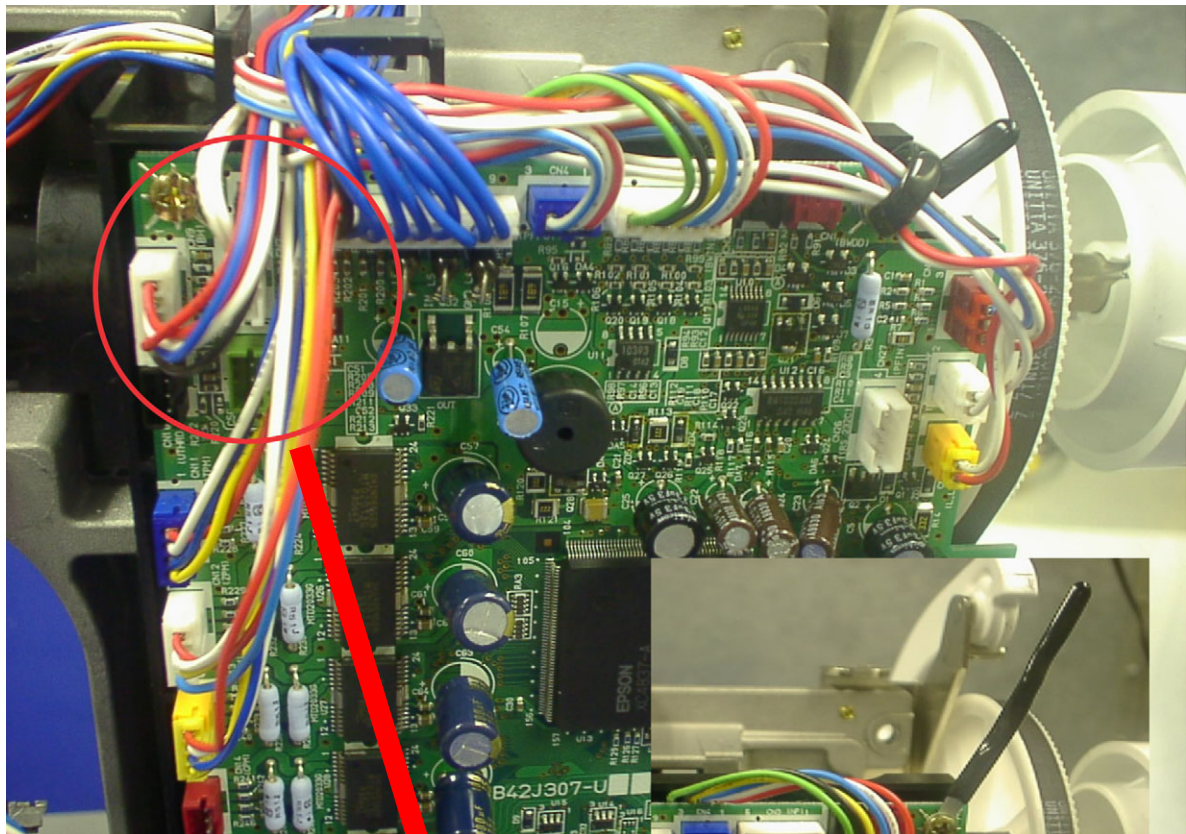

Route the lead wires as shown below.

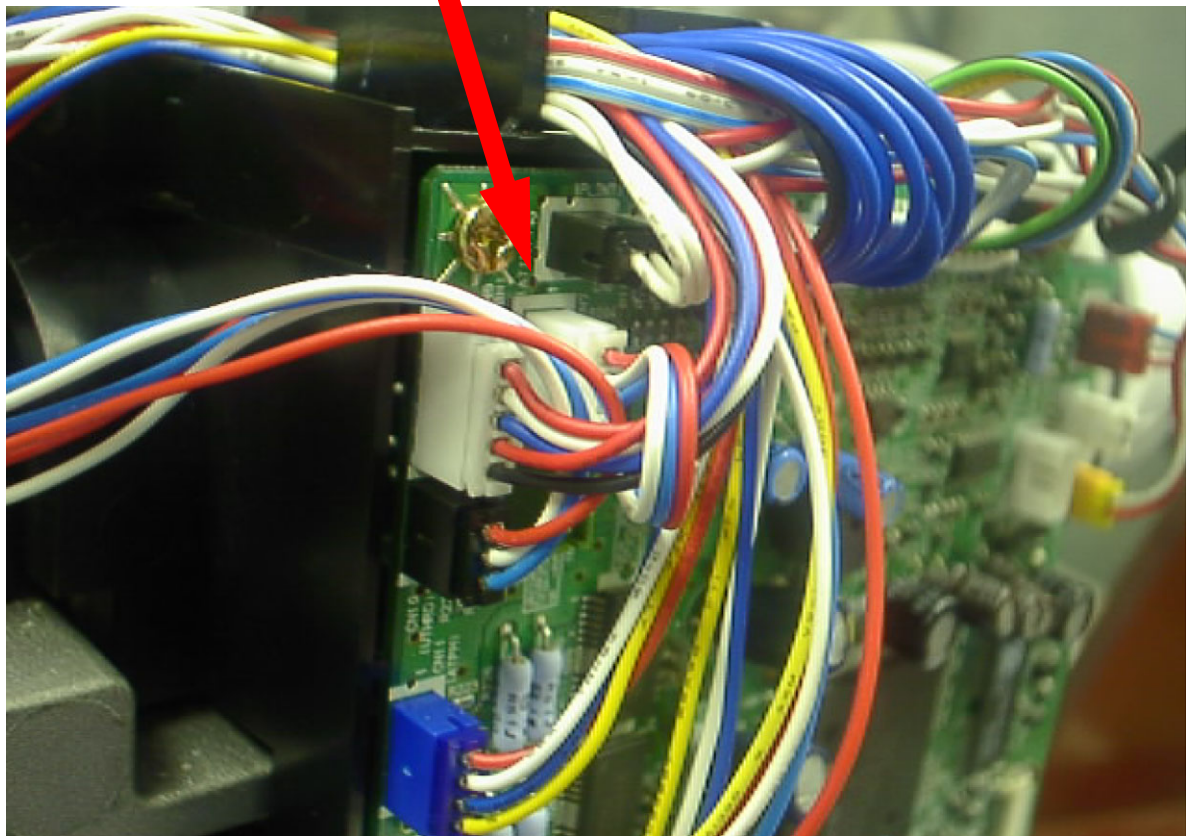



2. Wiring at lower section of main PCB

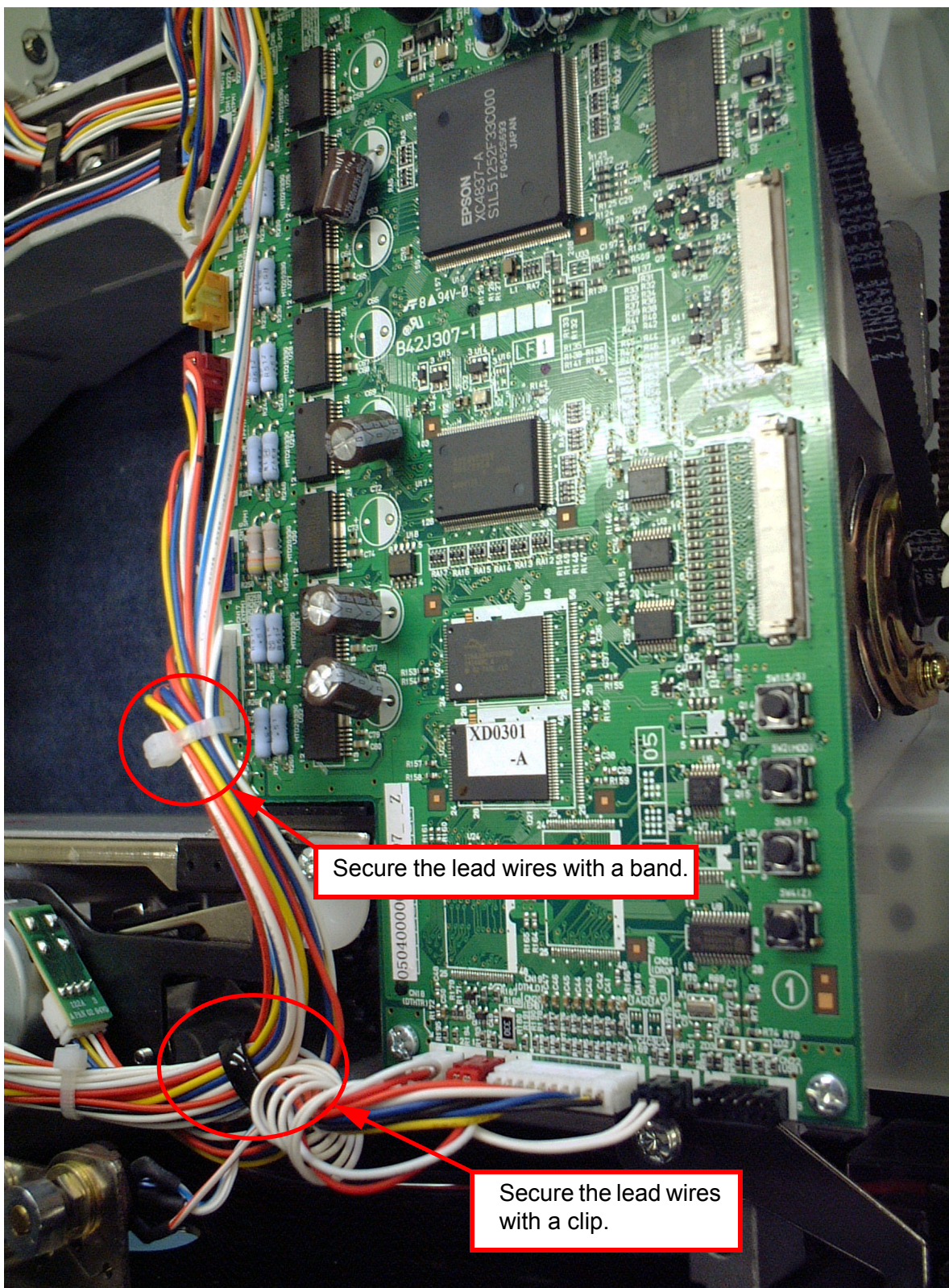

Secure the lead wires with a band.

Secure the lead wires with a clip.



1. Wiring at front side of front cover

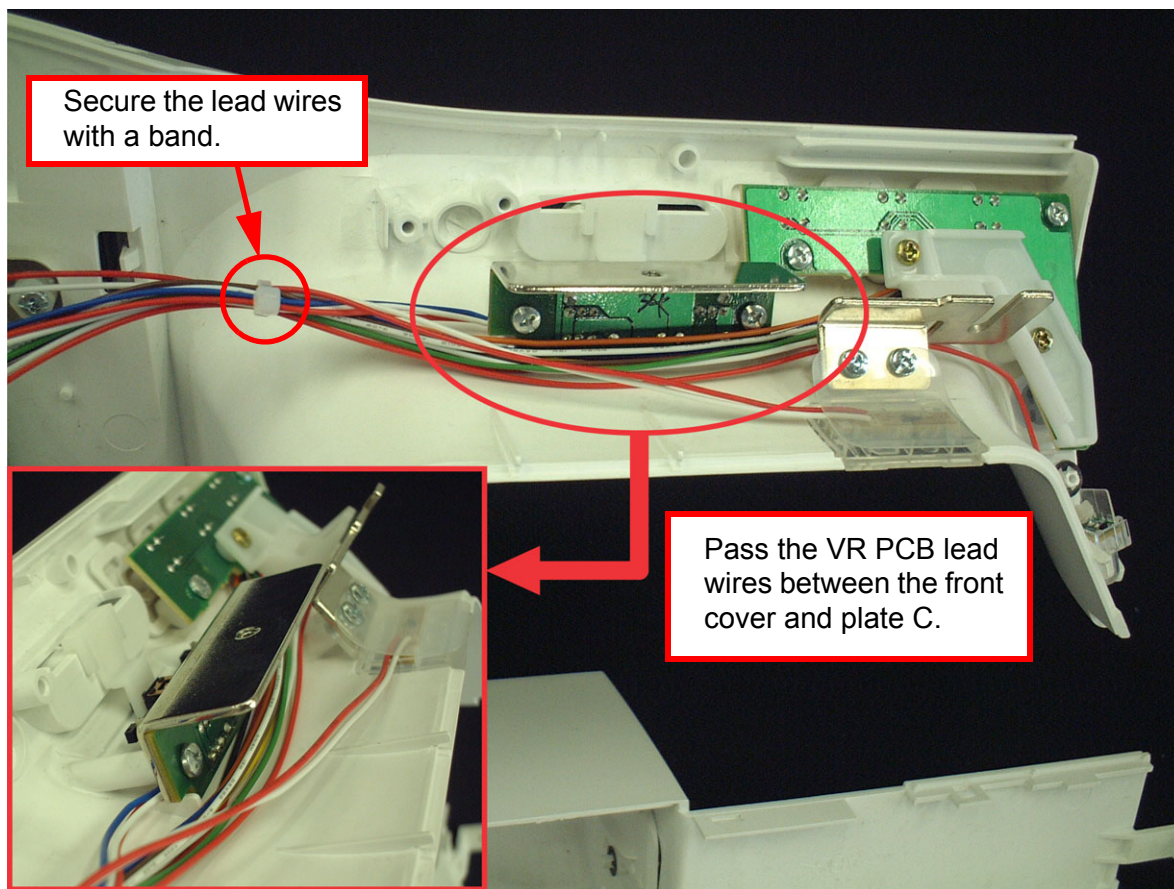

2. Wiring of inverter cover

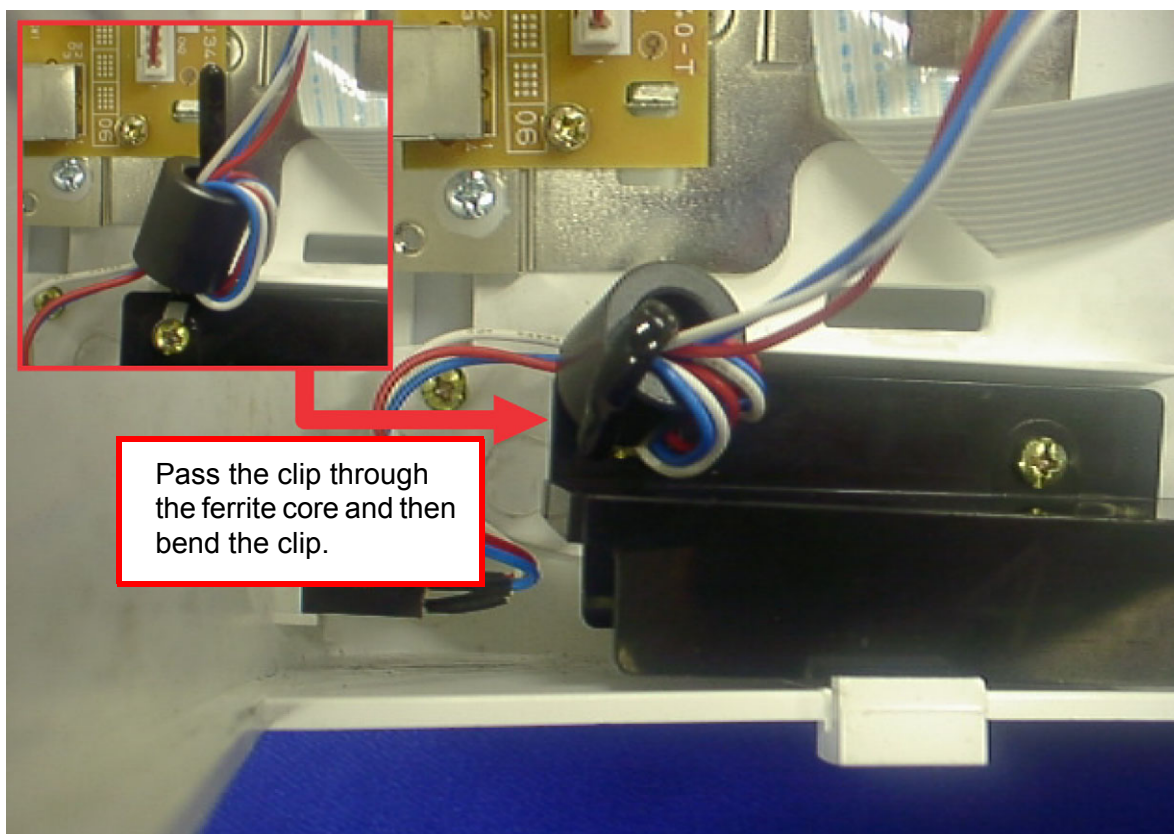

3. USB lead wire treatment

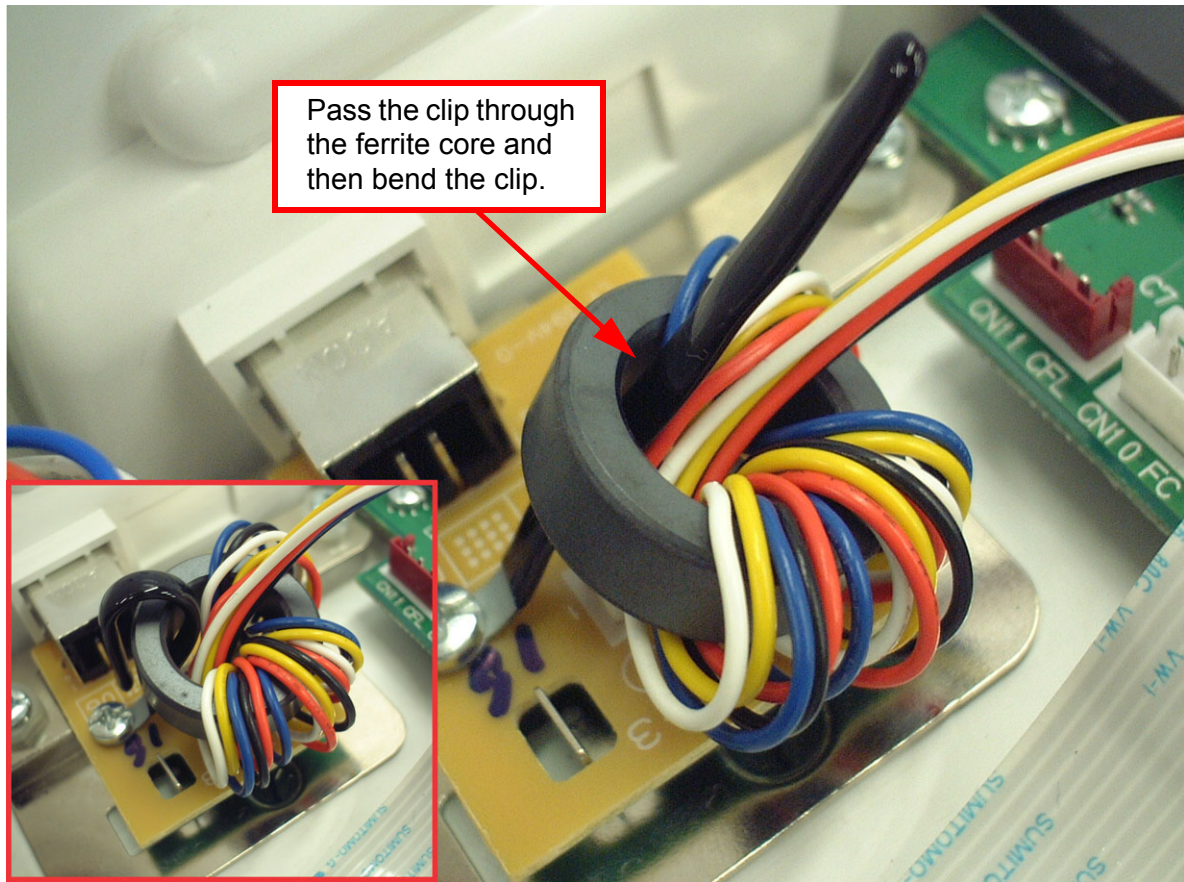



Follow the steps below to route the lead wires of the bobbin winder unit.

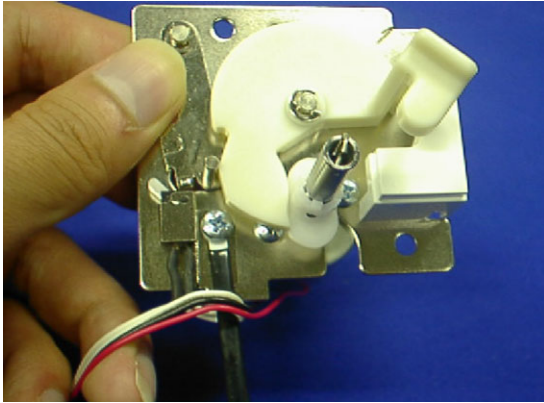

1. Hang four lead wires over the clip as shown in the photo on the left.

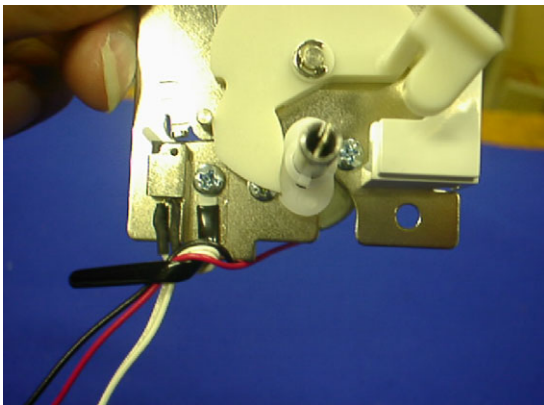

2. Bend the clip to the left.

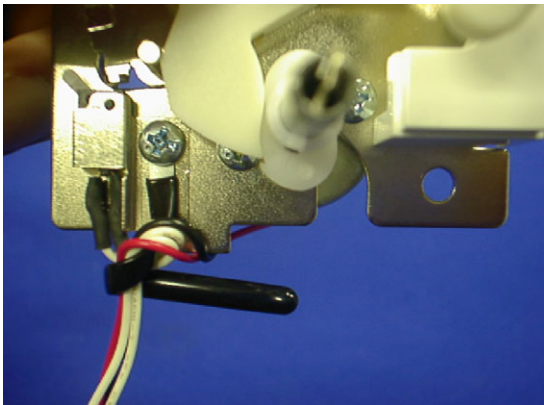

3. Bend the clip to the right

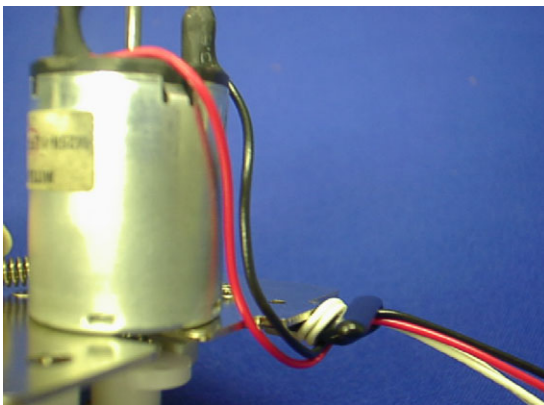

4. Leave enough slack in lead wires so that they lightly contact the motor when pressing the section indicated by the arrow in the photo with your fingers.



***BLN ESANTE***

BLN ESANTE  
04G05HF882U72