

SINGER AUTOMATIC SWING-NEEDLE MACHINES OF CLASS 401

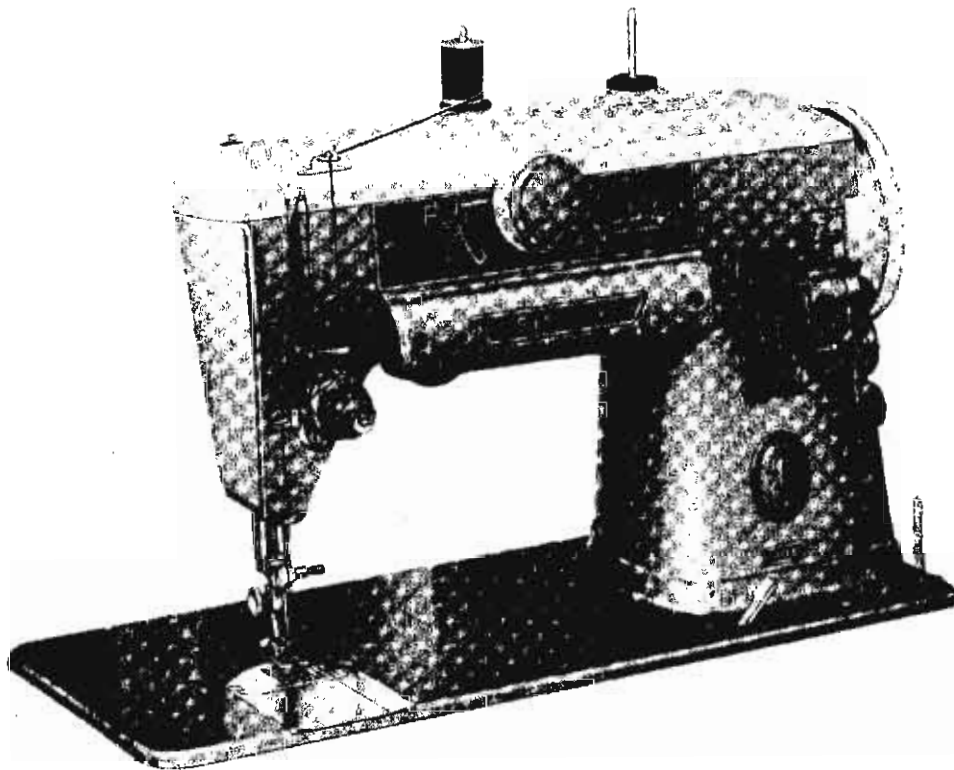

Fig. 265. Machine 401A

The instructions on **pages 1 to 79** generally apply to Class 401 Automatic Swing-Needle Machines.

Specific instructions which apply only to Machines of Class 401 appear on **pages 125 to 162**.

For detailed information concerning OPERATION of Machines of Class 401, see regular instruction book, **Form 20857**.

PREPARATION OF MACHINE FOR INSPECTION

Before any extensive inspection is undertaken to find causes of faulty operation, machine should be thoroughly cleaned and oiled.

Remove all lint, dust or other foreign particles from machine.

Remove motor, light and wiring harness, as described on **pages 145 to 147** and dip machine in large container of Varsol. If grease or dirt has become considerably hard and tacky it may be neces-

sary to leave machine in Varsol for several hours.

Wipe machine clean and dry.

Oil the machine as instructed below and on **page 127**.

Wipe away all surplus oil.

See **pages 4 to 7** for general tips on setting up and inspection.

LUBRICATION

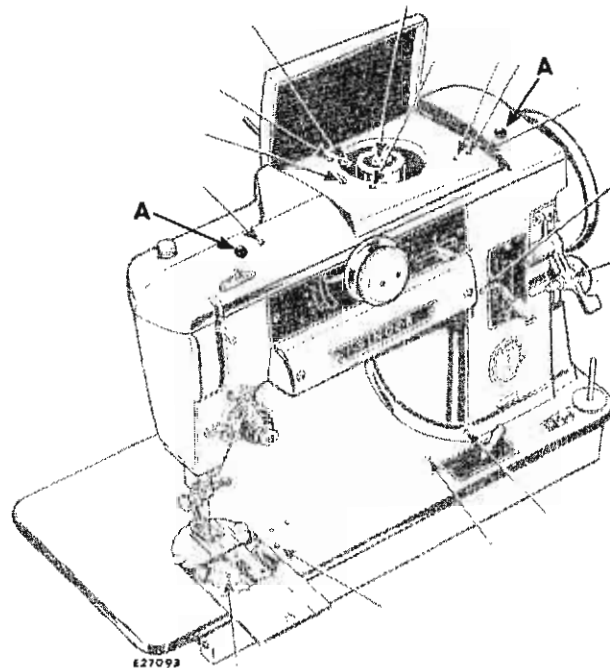

Fig. 266. Front View — Oiling

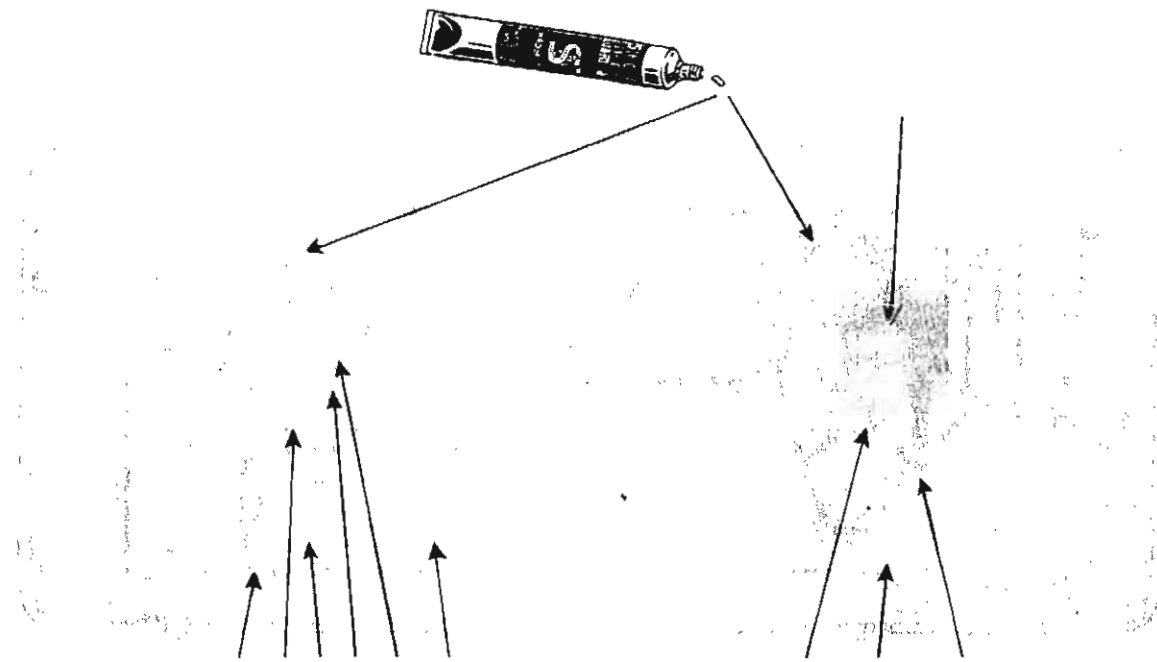

Fig. 267. Bottom View — Oiling

Open the face plate to oil the places indicated in Fig. 268. Tilt machine back on its hinges. Set the controls at A-K-5 for access to take-up linkage.

Keep all gears well lubricated with **SINGER GEAR LUBRICANT**.

Fig. 267 shows the two sets of gears beneath the machine bed.

Fig. 269 shows the other two sets of gears at top of arm. To reach these gears, loosen the two screws A, Fig. 266 and remove arm top cover.

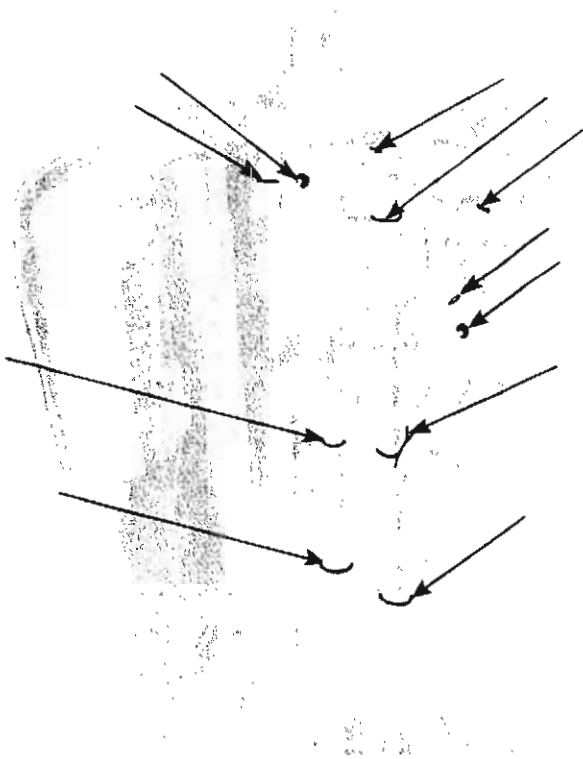

Fig. 268. End View — Oiling

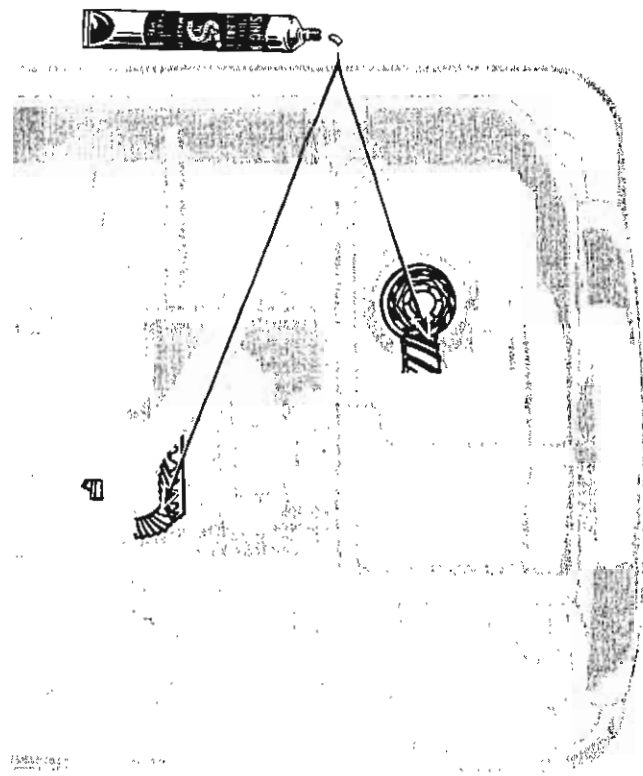

Fig. 269. Gears at Top of Arm

TO SET PRESSER FOOT AT CORRECT HEIGHT

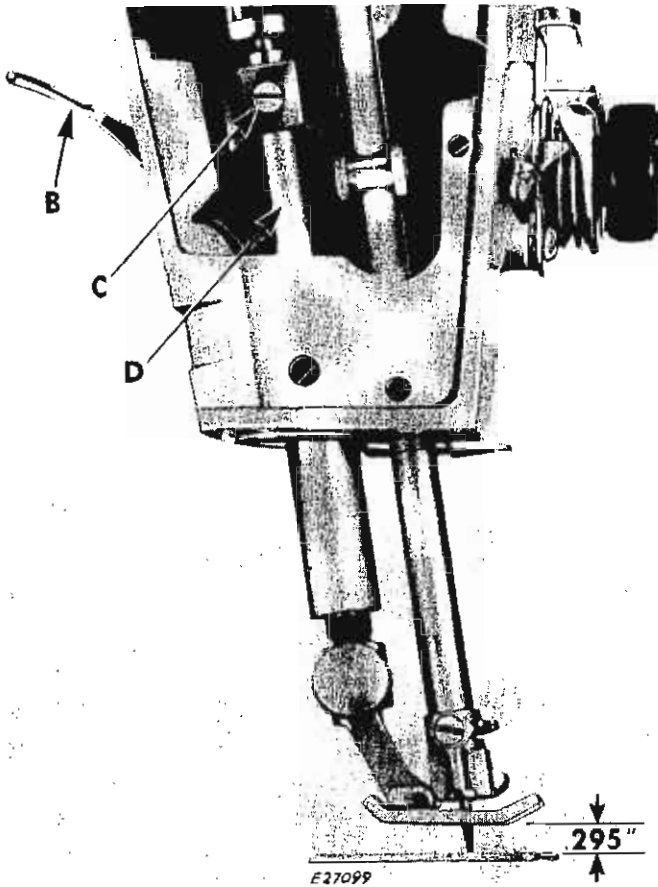

Fig. 270. Setting Presser Foot at Correct Height

IMPORTANT: Unless presser foot is set at correct height, attachments for this machine may not fit correctly on presser bar.

CAUTION: Throat plate must be **down**, flush with bed slide, while setting presser foot height.

CHECK:

Raise presser bar lifter **B**, Fig. 270, raising presser foot to highest position.

Bottom of presser foot should be .295 inch above top of throat plate.

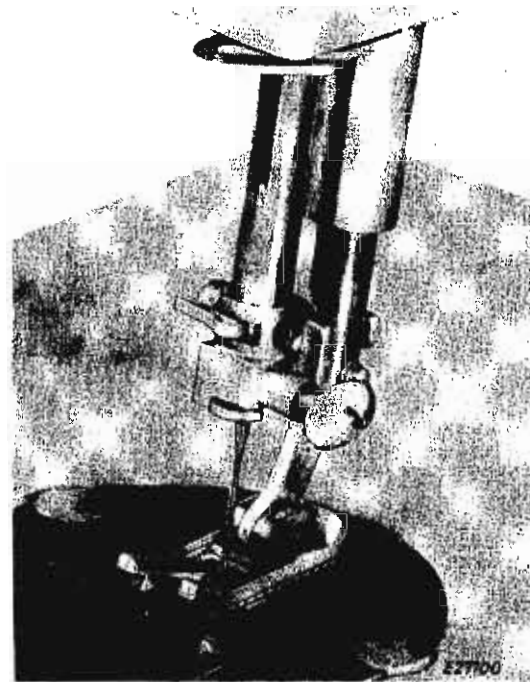

Fig. 271. Presser Foot in Alignment with Slots in Throat Plate and with Feed Dog

Test alignment of presser foot to slots in throat plate and to feed. Fig. 271 shows presser foot in correct alignment. (See instructions on page 57.) Height of presser foot and alignment with slots in throat plate must be set at same time.

NOTE: On Machines of Class 401, the first four pairs of teeth are **not** lower than the rear teeth but are level with them, as shown in Fig. 274. Therefore, tissue paper cannot pass beyond front teeth when feed dog and presser foot are in proper alignment.

SETTING:

Loosen set screw **C**, Fig. 270. Raise or lower presser bar **D** as required.

Align presser foot and securely tighten screw **C**.

TO SET FEED DOG AT CORRECT HEIGHT

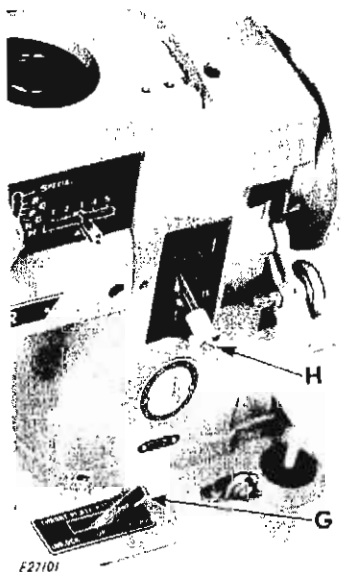

Fig. 272. Machine Set for Sewing at 12 Stitches per Inch

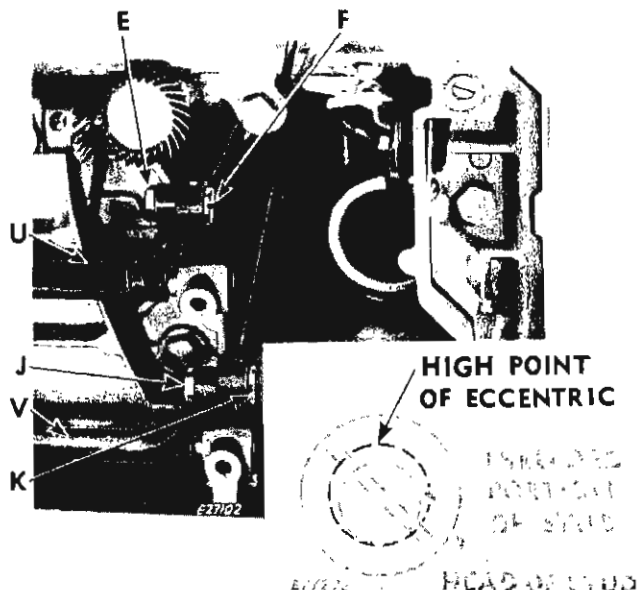

Fig. 273. Feed Adjustments

PREPARATION :

Remove bottom cover, motor hold-down plate and motor, as instructed on page 145.

Set throat plate position lever **G**, Fig. 272 at "DOWN" position for sewing and set machine for forward stitching at approximately 12 to 15 stitches per inch as shown at **H** in Fig. 272.

Turn machine pulley over toward operator until feed dog is at its highest position.

CHECK:

With feed dog at highest position, feed dog teeth should project .040 to .043 inch above top surface of throat plate, as shown in Fig. 274. Use Gauge No. G34202 for setting correct feed dog height as shown in Fig. 38A, page 30.

SETTING:

Loosen nut **E**, Fig. 273 and turn eccentric stud **F** until high point of eccentric is toward rear of machine bed, as shown in Fig. 273 (inset), making the distance between stud **F** and feed lifting rock shaft **U** as short as possible. Then turn eccentric stud **F**, as required to bring feed dog to correct height. Maintain this setting while tightening nut **E** securely.

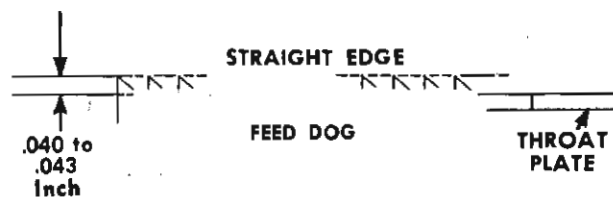

Fig. 274. Feed Dog at Correct Height

TO SET FEED DOG LENGTHWISE IN THROAT PLATE SLOTS

PREPARATION :

Set feed dog at correct height as instructed above.

Set throat plate position lever **G** and stitch regulator **H**, as shown in Fig. 272.

CHECK:

Feed dog should be as close as possible to needle slot in throat plate without striking, to insure efficient performance of stitching mechanism.

SETTING:

Loosen nut **J**, Fig. 273.

Turn eccentric stud **K** until high point of eccentric is toward rear of machine bed, as shown in Fig. 273 (inset), making distance between stud **K** and feed rock shaft **V** as short as possible. Then turn eccentric stud **K**, moving feed dog toward front or rear as required. Securely tighten nut **J**.

TO SET FEED DOG SIDEWISSE IN THROAT PLATE SLOTS AND TO ELIMINATE NOISE IN FEED MOVEMENT

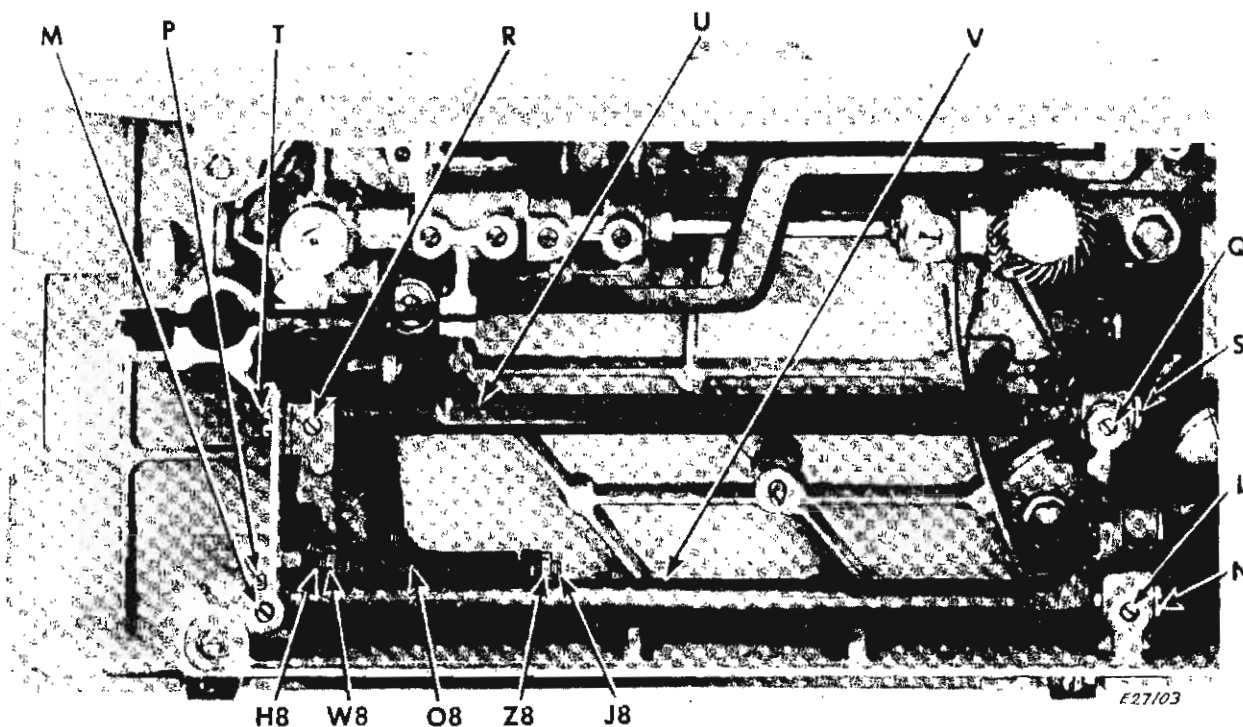

Fig. 275. Setting Feed Sidewise

PREPARATION :

Set the feed dog at the correct height as instructed on page 129.

CHECK:

The feed dog should be located centrally (along the bed) in the feed dog slots of the throat plate.

SETTING:

Loosen set screws **L** and **M**, Fig. 275 that hold screw centers **N** and **P** and feed rock shaft **V** in position.

Loosen set screws **Q** and **R**, Fig. 275 that hold screw centers **S** and **T** and feed lifting rock shaft **U** in position.

Loosen screw centers **S** and **T** slightly to permit movement of feed dog toward left or right.

To position feed dog toward left, loosen screw center **P** and tighten screw center **N** an equal amount, as required.

To position feed dog toward right, loosen screw center **N** and tighten screw center **P** an equal amount, as required.

When feed dog is centralized in throat plate, make certain screw centers **N** and **P** hold feed rock shaft snugly (without end play or binding). Then securely tighten set screws **L** and **M**, Fig. 275.

Tighten screw centers **S** and **T** equally upon feed lifting rock shaft **V** so that shaft **V** rides freely without end play or binding. Then securely tighten set screws **Q** and **R**, Fig. 275.

NOTE: Check for end play or binding in feed bar **O8**, Fig. 275. To adjust, loosen nuts **W8** and **Z8** and turn screw centers **J8** and **H8**, as required. Re-check sidewise position of feed dog, and adjust if necessary, as instructed above. Tighten nuts **W8** and **Z8**.

TO ADJUST THREAD CLEARANCE

PREPARATION :

Remove needle, throat plate and bed slide.

CHECK:

Using narrow feeler gauge, Serial No. 187928, check these thread clearances —

At **A2**, Fig. 280, between bobbin case cushion spring and heel of bobbin case, there should be a clearance of .012 to .014 inch.

At **B2** on other side of spring, between spring and bracket — clearance should be .012 to .014 inch.

At **C2**, between hook race and underside of spring — clearance should be .016 to .018 inch.

Clearance between rear corner of bobbin case and top of spring, shown at **D2**, Fig. 276 should be approximately 3/64 inch. This distance can be checked with a simple scale rule.

Check for wear and need for replacement of cushion spring and of screws **E2** and **F2**, Fig. 276.

SETTING:

To adjust clearances at **B2**, **C2** and **D2**, Fig. 276, loosen screws **E2** and **F2** and move cushion spring as required.

NOTE: Hole in spring for screw **E2** is elongated and hole for screw **F2** is oversize to facilitate adjustment.

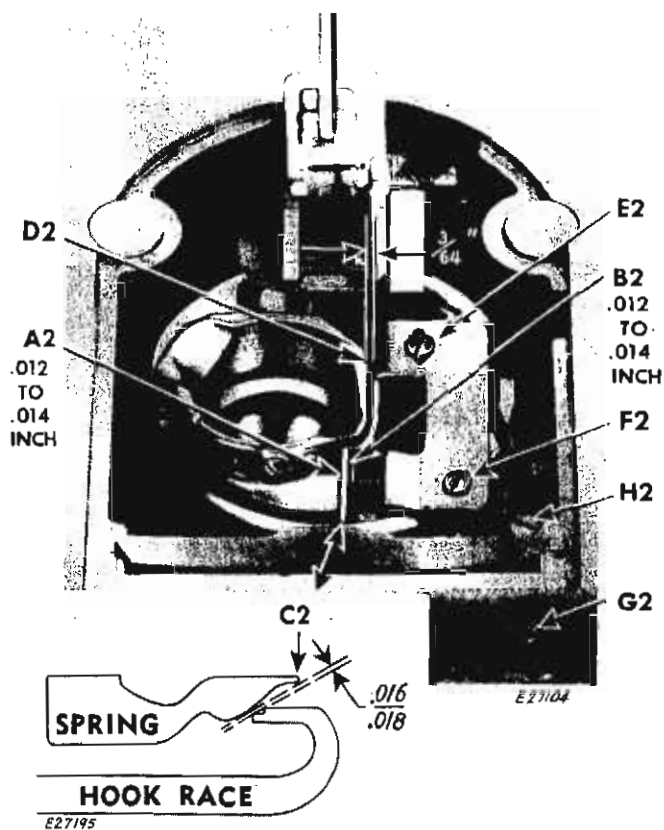

Fig. 276. Thread Clearances

Move spring toward rear to increase clearance **C2** or toward front to decrease clearance **C2**.

To adjust thread clearance at **A2** (.012 to .014 inch), loosen set screw **G2** and turn eccentric stud **H2** as required to move spring and bracket toward or away from bobbin case heel. Securely tighten screw **G2**.

When all three clearances have been obtained, at same position of spring, securely tighten screws **E2** and **F2**.

FEED TIMING

CAUTION: Feed eccentric is correctly set at the factory.

This timing should not be altered.

TO SET THE CHECK SPRING

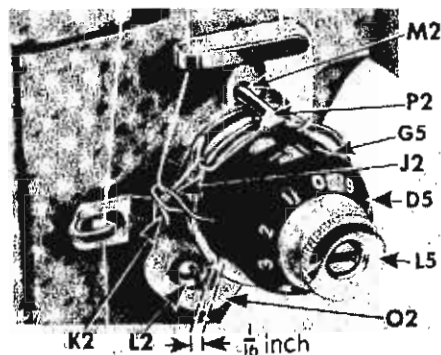

Fig. 277. Setting the Stroke

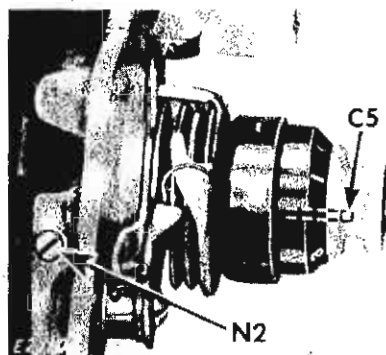

Fig. 278. Stud Set Screw

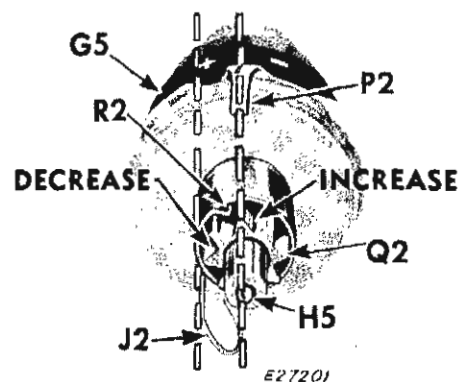

Fig. 279. Setting Tension

SETTING THE STROKE:

Loosen screw **L2** and move regulator **O2** until right end of slot in regulator is $\frac{1}{16}$ to $\frac{3}{32}$ inch to right of head of screw **L2**, as shown in **Fig. 277**. Move regulator up toward left for shorter stroke or down toward right for longer stroke. Tighten screw **L2**.

SETTING THE TENSION:

Loosen stud set screw **N2**, **Fig. 278** and remove entire assembly, as shown in **Fig. 279**.

Hold tension assembly so that component parts are in position shown in **Fig. 279**.

Place end **R2** of spring **J2** in groove of sprocket **Q2** so that spring will hang down as shown; with line of spring **J2** parallel to a line that bisects the dividing line between the plus (+) and minus (-) lines on indicator **G5**, the extension **P2** and the pin **H5**, as shown in **Fig. 279**. Increase or decrease tension by moving end **R2** of spring **J2** to some other groove in direction shown by arrows in **Fig. 279**. Replace assembly. Draw spring **J2** to rest on stop **K2**, **Fig. 277** and recheck tension. Tighten set screw **N2**, **Fig. 278**.

TO ADJUST NEEDLE THREAD TENSION

Use #50 mercerized thread.

Lower the presser bar.

Check for a **slight perceptible tension** on needle thread.

When tension is incorrect, turn thumb nut **L5**, together with the numbered dial **D5**, over toward the left until the "0" is at the top, as shown in **Fig. 277**.

Now insert pin **C5** in various holes of the dial **D5** until one is found which gives a **slight perceptible tension** when the thumb nut **L5** is turned to the extreme left and the numeral "0" is on top of the dial, as shown in **Fig. 277**.

NOTE: There should be no tension when dial **D5** is turned over toward left to a point between "0" and "9".

This tension gradually **increases** with the turning

of the thumb nut **L5** over toward the right; providing the full range of tensions required from light to heavy (with but one revolution of the thumb nut **L5**).

TO SET NEEDLE BAR AT CORRECT HEIGHT

PREPARATION:

Set red lever at #3 position and stitch selector knobs at **A** and **K**, as shown in Fig. 295, page 142.

Insert two needles (same size) up into needle bar.

CHECK:

Turn hand wheel over toward operator until needle bar is at its lowest point. At this position the **UPPER** timing mark on the needle bar should be level with lower end of needle bar ball bushing **Z**, as shown in Fig. 280.

Then turn hand wheel until hook point is behind needles. If needle bar is correctly turned, both needles will be **an equal distance in front of the point of the hook**.

SETTING:

Turn hand wheel over toward operator until needle bar is at lowest point.

Loosen screw **W**, Fig. 280.

Raise or lower needle bar, as required.

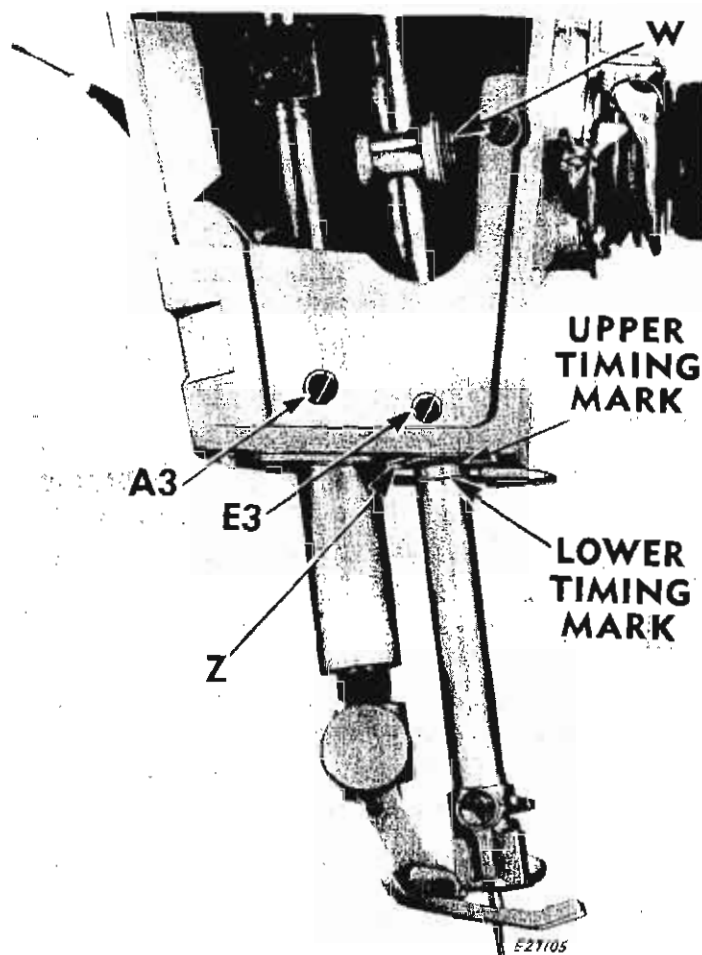

Fig. 280. Timing Marks on Needle Bar

While maintaining needle bar at correct height, make certain needle bar is correctly turned, then tighten screw **W**.

TO CHECK THE POSITION OF THE NEEDLE IN RELATION TO STRAIGHT-STITCHING THROAT PLATE

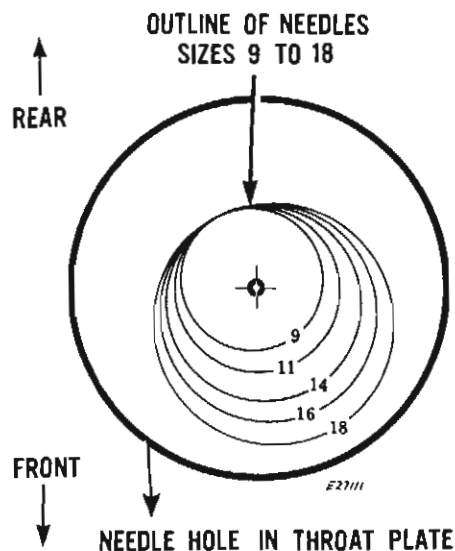

Fig. 281. Needle Hole in Straight-Stitching Throat Plate

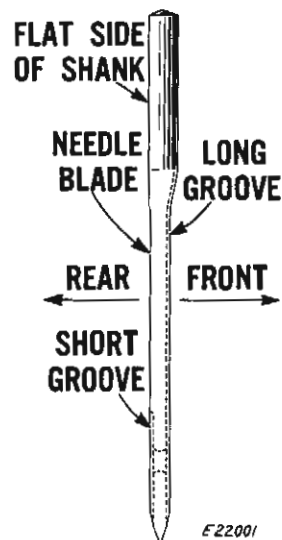

Fig. 282. 15 x 1 Needle

PREPARATION:

Set red lever at **#3 position** and selector knobs at **A** and **K**, for straight-stitching at central position, as shown in **Fig. 295, page 142**.

Install straight-stitching throat plate.

CHECK:

When the needle enters the needle hole in **straight-stitching throat plate**, the short-groove (flat shank) side of the needle should face slightly to the left of rear, as shown in **Fig. 281**.

Although the size of the needle may be changed to suit sewing requirements, the position of the **flat shank side of the needle remains CONSTANT in relation to the needle hole** in the throat plate.

Observe that the center of a Size #11 needle should be at the approximate center of the needle hole in the throat plate and that the center of each larger size needle advances toward the **front** of the needle hole.

This position is necessary to permit an increase in the diameter of the needle blade toward the front without disturbing the proper relationship between the needle and the sewing hook. This position of the

needle will also maintain sufficient clearance for the needle thread.

At no time should the needle touch the edge of the needle hole. The needle should never strike the presser foot.

If the needle is incorrectly located in the throat plate hole: —

Needle bar setting may be incorrect from front to back or from right to left (see **page 142**).

Needle bar shakes in ball bushings (see **page 142**).

Needle or needle bar may be bent. (Replace.)

Needle seat in needle bar may be clogged with dirt or be damaged (see **page 126**).

Throat plate may be incorrectly seated (see **page 152**).

If the needle strikes the presser foot, any of the above conditions may be at fault, or:

Presser bar may be bent, damaged or turned out of position (see **page 128**).

Presser foot may be incorrectly seated on the presser bar.

Presser foot may be bent. (Replace.)

Not for resale! (Courtesy: Sewing Dude Blog.)
TO ELIMINATE SIDE-SHAKE OR BINDING OF NEEDLE BAR

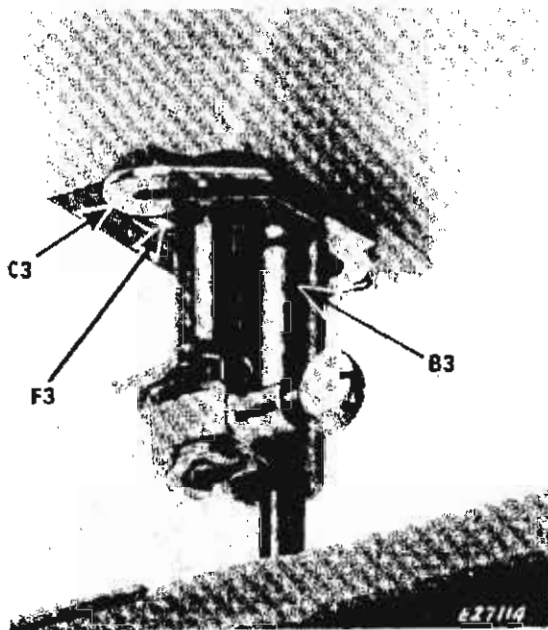

Fig. 283. Lower Needle Thread Guide

End play or binding of needle bar is usually the result of an incorrectly adjusted ball bushing at **F3**, **Fig. 283** or **H3**, **Fig. 283A**.

To adjust lower ball bushing, first remove presser foot. Loosen screw **A3**, **Fig. 280**, page 133 and lower presser bar bushing **B3**, **Fig. 283** and guide **C3**, **Fig. 283**.

Loosen set screw **E3**, **Fig. 280**.

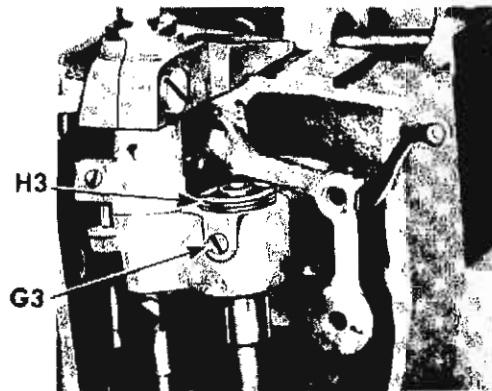

Fig. 283A. Upper Ball Bushing

Loosen or tighten adjusting screw at **F3**, **Fig. 283**, as required. (Use a 1/2 inch spanner wrench.)

Upper ball bushing may be adjusted with a 1/2 inch spanner wrench at **H3** after loosening set screw **G3**, **Fig. 283A**.

CAUTION: Tightening the set screws **E3** and **G3** may tend to make the ball bushing bind slightly. Adjust accordingly, setting ball bushings individually. Then tighten set screws **E3** and **G3**.

Replace needle thread eyelet **C3** on groove in presser bar bushing **B3**, as shown in **Fig. 283**.

Replace presser bar bushing **B3** with needle thread eyelet, as shown in **Fig. 283**.

Tighten set screw **A3**, **Fig. 280**.

CHECK THESE POINTS WHEN STITCH REGULATOR STICKS, CREEPS OR BINDS

1. Looseness of screws.
2. Dirt on, or damage to moving parts.
3. Feed rock shaft centers too loose or too tight.
4. Bent stitch regulator handle.
5. Too much friction in friction fork on stitch regulator.
6. Bent feed regulator connection rod.
7. Worn or jammed slide block in feed forked connection.
8. Worn or damaged feed rock shaft.
9. Binding in feed lifting rock shaft connecting rod.
10. Too much pressure on presser bar when sewing heavy material.

TO ELIMINATE END PLAY OR BINDING OF FEED ROCK SHAFT AND FEED LIFTING ROCK SHAFT

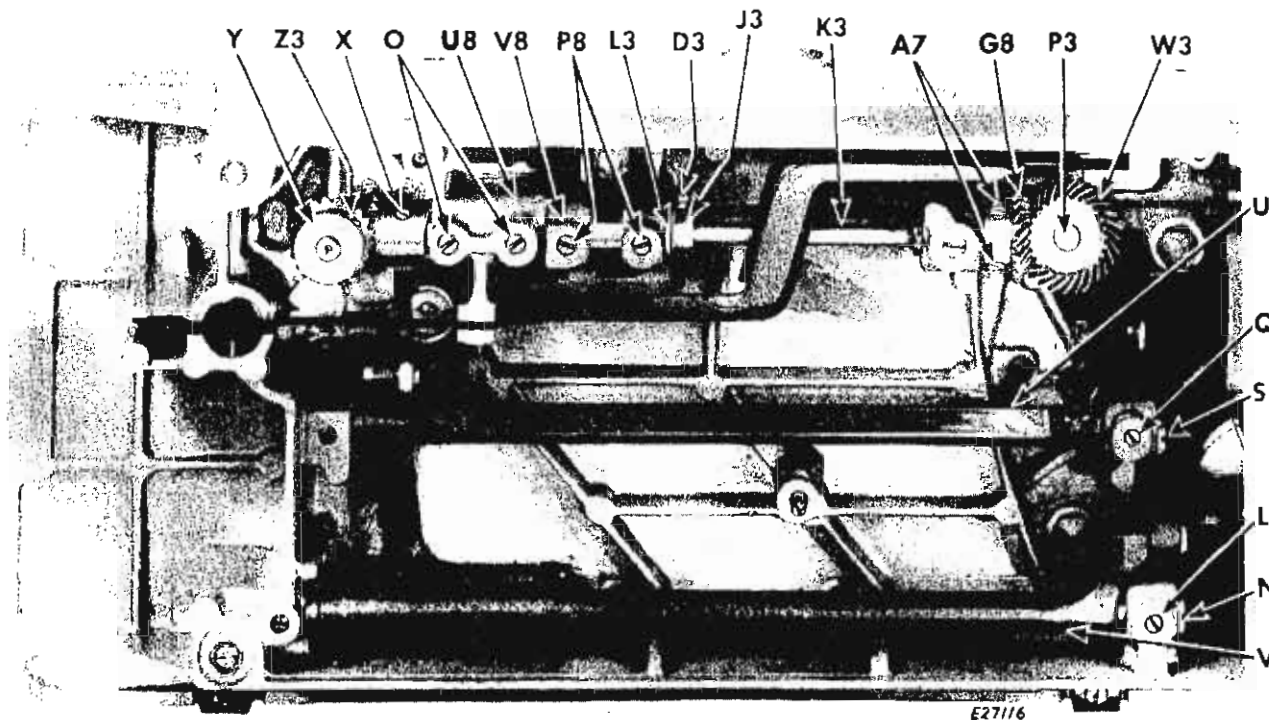

Fig. 284. Elimination of End Play or Binding
beneath Machine Bed

To eliminate end play or binding of feed rock shaft **V**, Fig. 284, loosen set screw **L** at right end of shaft and adjust screw center **N**, so that shaft rides snugly but freely, (without any left or right movement).

Securely tighten set screw **L**.

To eliminate end play or binding of feed lifting rack shaft **U**, Fig. 284, loosen set screw **Q** at right end of shaft and adjust screw center **S**, as required.

Securely tighten set screw **Q**.

Check and adjust feed bar for end play or binding, as instructed on **page 130**.

TO ELIMINATE END PLAY OR BINDING OF HOOK DRIVING SHAFT

To eliminate end play or binding of hook driving shaft **K3**, loosen two set screws **O** and two set screws **P8**, Fig. 284. Then loosen set screw **D3** in collar **J3**, Fig. 284 and two set screws **A7** in bevel gear **G8** at right end of shaft.

Check for end play on rotating hook shaft. To adjust, loosen set screw **Z3**. Press gear **Y** up against its bearing and retighten screw **Z3**.

NOTE: KEEP ALL GEARS IN MESH. (See **CAUTION** at top of **page 154**.)

Hold hook bracket **U8** against lug **V8** and push bushing **L3** toward left against bevel gear at left end of shaft **K3** so that there will be no looseness nor binding. Securely tighten two set screws **P8** and two set screws **O**, Fig. 284. Press collar **J3** firmly against bushing **L3** and tighten set screw **D3**. Adjust gear mesh at right end of shaft **K3** so that there is neither backlash nor binding. While maintaining this adjustment, tighten the two set screws **A7** in gear **G8**.

Check timing of hook, as instructed on **page 143**.

Adjust position of hook in relation to needle as instructed on **page 144**.

TO ELIMINATE END PLAY OR BINDING OF UPRIGHT ARM SHAFT

To eliminate end play or binding of upright arm shaft **P3**, Fig. 284, page 136, loosen set screw in lower bevel gear **W3**.

See **CAUTION** on page 154.

While pressing downward upon shaft **P3** from top

of machine, set gear **W3** firmly against bearing on casting and tighten its set screw.

Adjust hook driving shaft for end play or binding, as instructed on page 136.

Adjust horizontal arm shaft for end play or binding, as instructed below.

TO ELIMINATE END PLAY OR BINDING OF HORIZONTAL ARM SHAFT

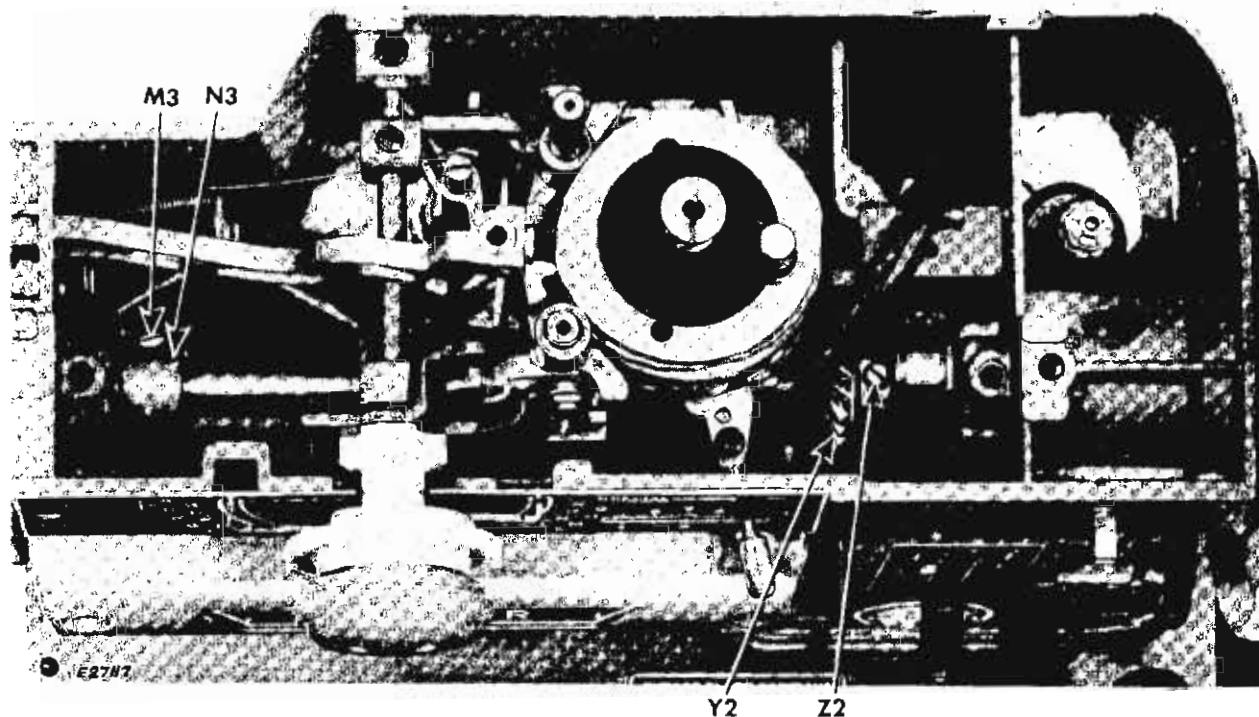

Fig. 285. Adjustments for End Play or Binding of Arm Shaft

When horizontal arm shaft binds, first check to make certain that mesh between the arm shaft worm and the cam stack worm wheel is not too tight. Do this by removing cam stack as instructed on page 158. If the binding is thus released, the eccentric shaft **F8**, Fig. 323, page 159 requires adjustment, as instructed on page 159.

If arm shaft still requires adjustment for end play or binding, loosen set screw **M3** in collar **N3**, Fig. 285. Turn hand wheel until set screw **Z2** on eccentric appears in hole in cap of connecting rod as shown in Fig. 285. Loosen screw **Z2**.

While keeping timing screw **Z2** in groove provided for it in arm shaft, push needle bar crank toward hand wheel end of machine and press bevel gear **Y2**,

Fig. 285 firmly in mesh, without backlash or binding, with bevel gear at top of upright arm shaft. (See **CAUTION** at top of page 154.)

Tighten set screw **Z2** and check for free running.

Press collar **N3** firmly against bushing in head of machine and tighten set screw **M3**.

Check timing of hook, as instructed on page 143.

NOTE: If there is considerable play between hand wheel and hand wheel gear, remove and disassemble hand wheel assembly, as instructed on page 150 and check seating of spring **D6**, Fig. 310.

TO SET THE INDEX PINS AT THE CORRECT HEIGHT

(See Fig. 286)

PREPARATION:

Remove arm top cover and special disc.

Remove lamp shade. Unfasten sewing light from arm of machine, as instructed on page 146.

CHECK:

Set selector knobs at **J** and **R**, as shown in Fig. 286.

At this setting, top surface of followers **O3** and **R3**, should be $\frac{1}{64}$ inch below top surface of cam stack **S3**, as shown in Fig. 286.

Position of followers **O3** and **R3** is determined by height of index pins **T3** and **W3**, respectively.

SETTING:

Loosen set screw **V3** (see inset at top left of Fig. 286) in rear of machine arm.

Raise or lower the rear index pin **T3**, as required. Securely tighten screw **V3**.

Loosen set screw **U3**, on the front of machine arm.

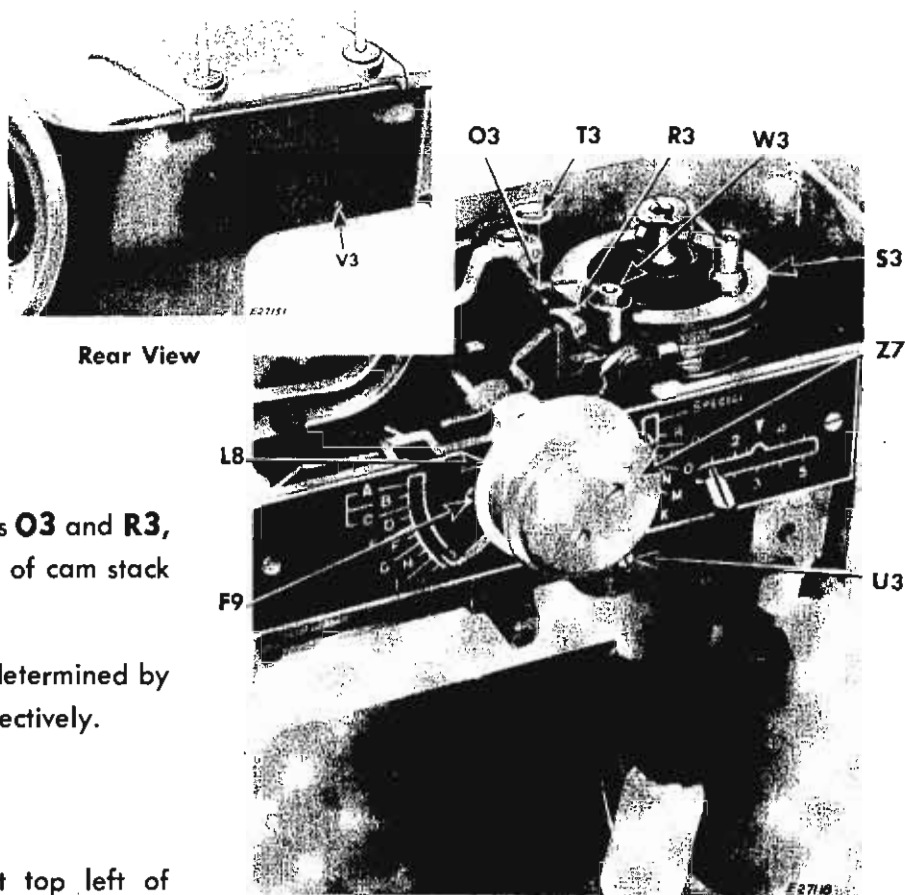

Fig. 286. Setting Index Pins

Raise or lower front index pin **W3**, as required.

Securely tighten screw **U3**.

TO TIME THE CAM STACK

PREPARATION:

Remove arm top cover and special disc.

Using selector knob **Z7**, Fig. 286 bring rear follower **O3** in contact with edge of top cam on cam stack, **S3**, Fig. 287.

Turn hand wheel over toward you until timing mark **X3**, is at point of contact with rear follower **O3**, as shown in Fig. 287.

CHECK:

At this setting, the needle bar should be at its lowest position.

SETTING:

Remove stud and spring **Y3**, Fig. 287.

Turn hand wheel over toward you slowly until needle bar is at its lowest position.

Loosen each of the three clamping screws **Q3**, **Fig. 287** (just one turn).

While holding needle bar at its lowest position, rotate entire cam stack **clockwise**, with the hand, until timing mark **X3** reaches point of contact with rear follower **O3**, as shown in **Fig. 287**.

Tighten the three clamping screws **Q3**.

Replace stud and spring **Y3**. Tighten stud.

Replace special disc and arm top cover.

TO SET CAM SELECTOR ARM STOPS

PREPARATION:

Remove arm top cover.

Check adjustment of worm wheel shaft, as instructed at bottom of **page 159**.

Make certain that screws **F9**, **Fig. 286** and **D8**, **Fig. 287** are securely tightened.

Set selector knobs at **D** and **L**, as shown in **Fig. 322**, **page 158**.

Turn hand wheel over toward front of machine until followers **O3** and **R3**, **Fig. 287**, rest upon high points of bottom (zigzag) cam in cam stack **S3**.

CHECK (Use feeler gauge):

At the above setting, when rear knob **L8**, **Fig. 286** is drawn toward front as far as possible, clearance between front follower **R3**, **Fig. 287** and high point of bottom cam should be .010 to .012 inch.

Also, when front knob **Z7**, **Fig. 286** is pressed toward rear as far as possible, clearance between rear follower **O3**, **Fig. 287** and high point of bottom cam should be .010 to .012 inch.

SETTING:

Loosen set screw **C9**, **Fig. 287**.

Set rear knob **L8** at position **L**.

Move stop **E9**, **Fig. 287** toward front until its front surface contacts rear face of selector arm **M8**, as shown in **Fig. 287**.

Tighten set screw **C9**.

Recheck clearance between front follower **R3** and bottom cam, as instructed.

Loosen set screw **A9**, **Fig. 287**.

Set front knob **Z7** at position **D**.

Press stop bushing **B9**, **Fig. 287** toward the rear until it contacts head of screw **D8**, **Fig. 287**.

Tighten screw **A9**.

Recheck clearance between rear follower **O3** and bottom cam as instructed.

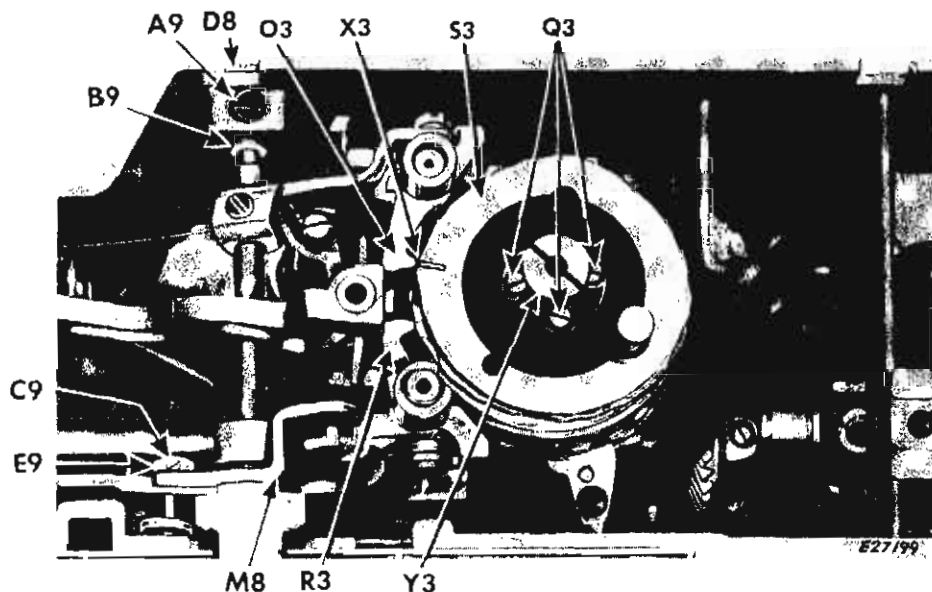

Fig. 287. Timing the Cam Stack

TO ZERO-OUT THE MACHINE

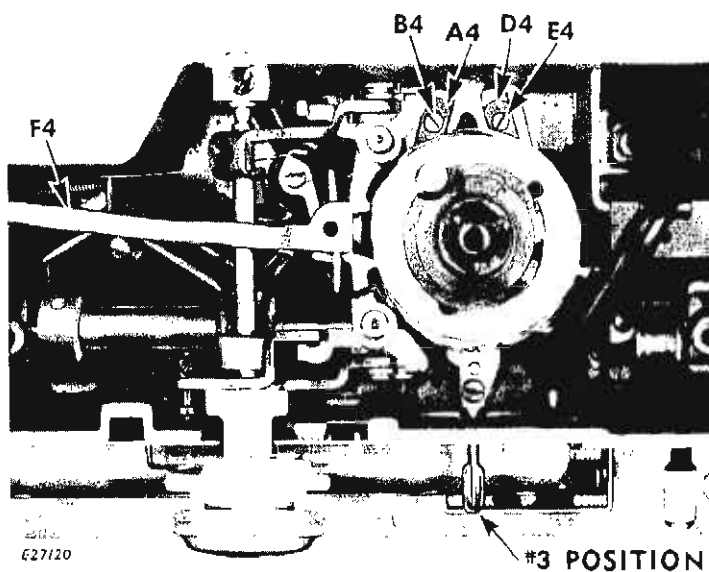
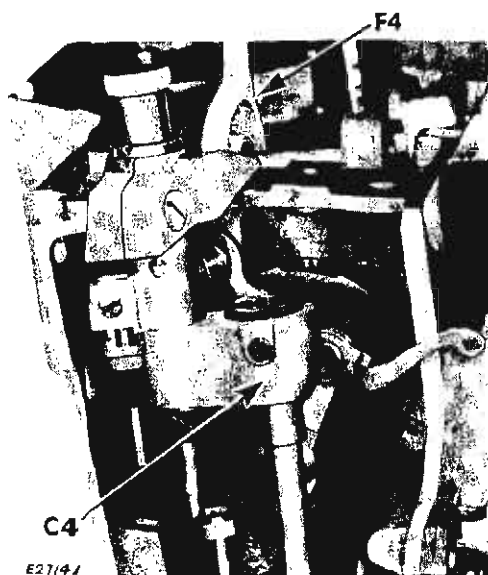

Fig. 288. Setting Bight Amplitude Stop Plates

PREPARATION:

Remove the arm top cover. Set the index pins at correct height, as instructed on **page 138**. Time the cam stack, as instructed on **page 139**.

CHECK (at #1 Position):

When machine is running with selector knobs set at "A" and "L" and red lever set at #3 position, move red lever slowly to #1 position as shown in **Fig. 289**. Movement of the needle bar driving arm **F4**, **Fig. 288** and needle bar vibrating bracket **C4** should stop at same time that movement of red lever stops at #1 position.

SETTING:

Loosen clamping screw **B4**, **Fig. 288**.

Move red lever to #3 position.

Run machine and move red lever **slowly** toward left to point where there is no movement of needle bar vibrating bracket **C4**. **DO NOT PASS THIS POINT.**

Maintain this position of red lever and move left stop plate **A4** forward against bight amplitude bracket beneath cam stack.

Hold stop plate at this setting and securely tighten screw **B4**.

CHECK (at #5 Position):

When the machine is running with selector knobs set at "D" and "K" and red lever set at #3 position, move red lever slowly to #5 position, as shown in **Fig. 290**. Movement of needle bar driving arm **F4** and needle vibrating bracket **C4**, **Fig. 288**, should stop at same time that movement of red lever stops at #5 position.

SETTING:

Loosen clamping screw **E4**, **Fig. 288**.

Move red lever to #3 position.

Run machine and move red lever **slowly** toward right to point where there is no movement of bracket **C4** or needle bar driving arm **F4**. **DO NOT PASS THIS POINT.**

Maintain this position of red lever and move right stop plate **D4** forward against bight amplitude bracket beneath cam stack.

Hold stop plate at this setting and securely tighten screw **E4**, **Fig. 288**.



Fig. 289. Setting: A-L-1



Fig. 290. Setting: D-K-5

TO CENTRALIZE THE NEEDLE BAR DRIVING ARM WITH THE DISC SELECTOR ARM BRACKET FOLLOWERS

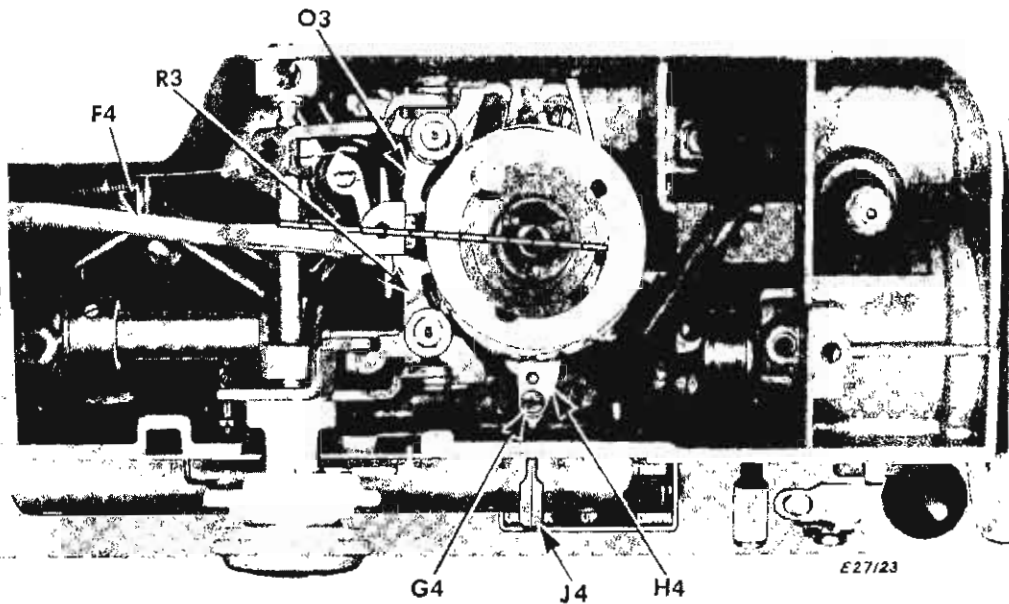

Fig. 291. Centralizing Needle Bar Driving Arm

PREPARATION:

Remove arm top cover.

Zero-out machine correctly, as instructed on page 140.

Set red lever at #3 position, as shown in Fig. 292.

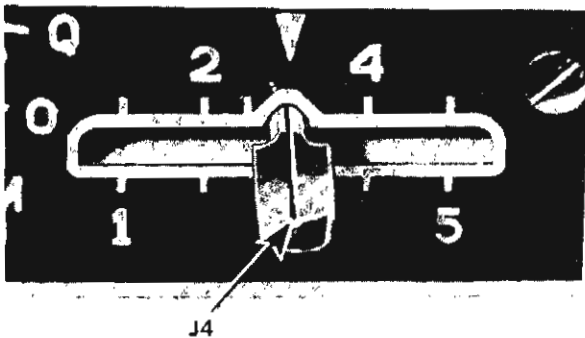

Fig. 292. Red Lever at #3 Position

CHECK:

When the bight amplitude (RED) lever is set at #3 position, the center line of the needle bar driv-

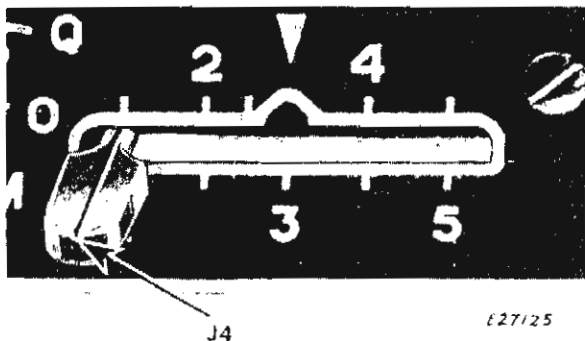

Fig. 293. Red Lever at #1 Position

ing arm F4 should coincide with a point midway between the followers O3 and R3, Fig. 291.

SETTING:

Loosen clamping screw G4, Fig. 291.

Push bight amplitude control lever bracket H4 toward the left as far as possible against the stop A4, Fig. 288.

Align center line groove J4, Fig. 293 with #1 position, as shown in Fig. 293.

Tighten screw G4.

Move red lever as far as possible to the right against the stop D4, Fig. 288. Groove J4 should now be in line with #5 position, as shown in Fig. 294.

If groove J4, Fig. 294 is not in line with #5 position, divide the "off" distance in half and, after loosening screw G4, position the red lever on bracket H4 so that it is an equal distance, from the center position #3, at stop positions #1 and #5.

Securely tighten screw G4.

Replace arm top cover.

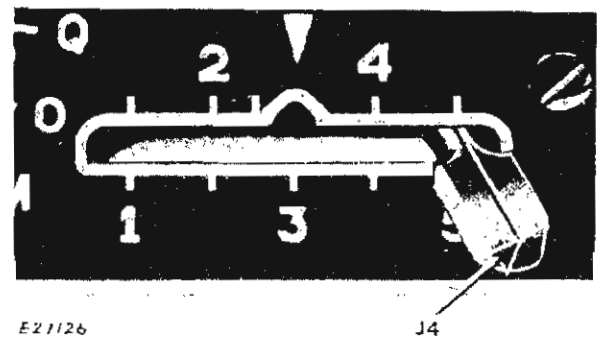

Fig. 294. Red Lever at #5 Position

TO CENTRALIZE THE NEEDLE IN NEEDLE HOLE IN STRAIGHT-STITCHING THROAT PLATE

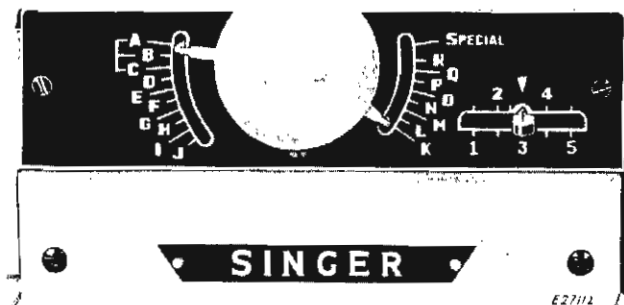

Fig. 295. Setting for Straight
Stitching at Central Position
(A-K-3)

PREPARATION:

Set red lever at position #3 and stitch selector knobs at A and K, as shown in Fig. 295.

Remove arm top cover and face plate.

Install straight-stitching throat plate.

Remove presser foot regulating thumb screw U2, Fig. 296.

Select a Size #11 needle. Check it for straightness and insert in needle bar.

SETTING (Front to Rear Position):

Loosen clamping screw S2 and set screw T2, Fig. 296.

Turn hand wheel until needle is in needle hole in throat plate.

While holding eccentric hinge pin V2, Fig. 296 down against casting and holding vibrating bracket C4, Fig. 296 up against shoulder of eccentric V2, turn eccentric V2 (with spanner wrench) until needle is located centrally from front to rear in needle hole in throat plate.

Press down upon eccentric V2 and tighten clamping screw S2, Fig. 296.

Press collar W2 up against bracket C4 and tighten screw T2, Fig. 296.

SETTING (Left to Right Position):

Loosen two clamping screws N7, Fig. 296.

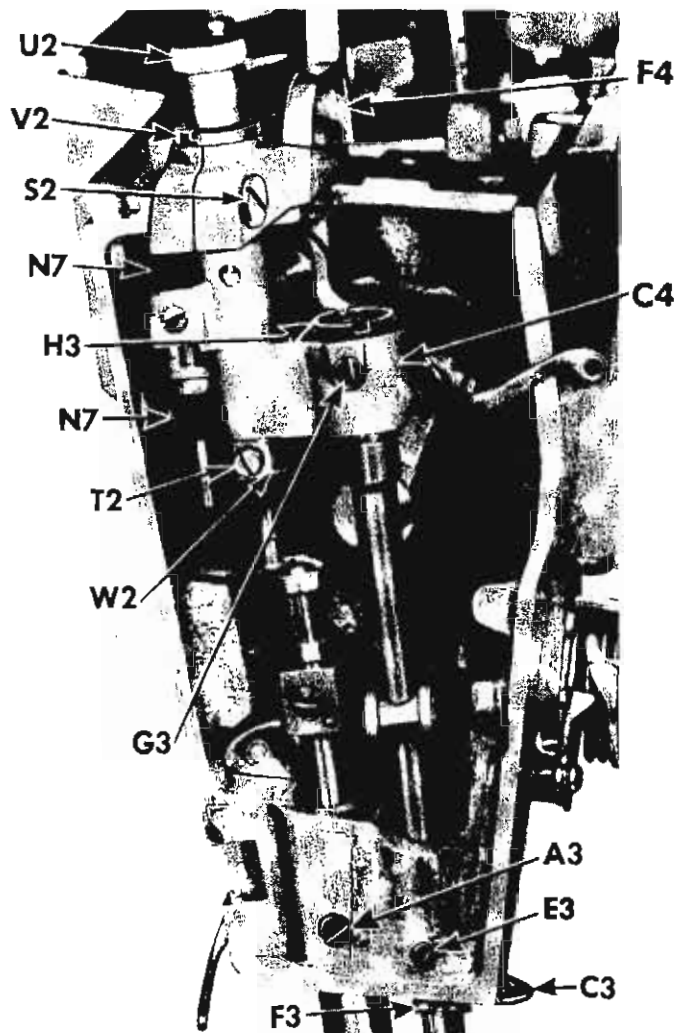

Fig. 296. Centralizing the Needle

Turn hand wheel until needle is in needle hole in throat plate.

While holding needle bar driving arm F4, to keep it from moving, move vibrating bracket C4, Fig. 296, as required to bring needle in center (left to right) of needle hole in throat plate.

Maintain this setting of bracket C4 and tighten two screws N7.

Check timing of hook, as instructed on page 143.

Check front to rear position of hook as instructed on page 144.

TO TIME THE ROTATING HOOK

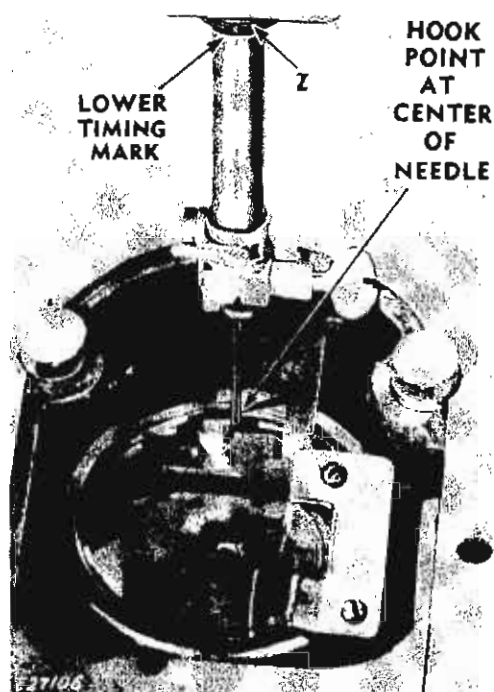

Fig. 297. Hook Correctly Timed

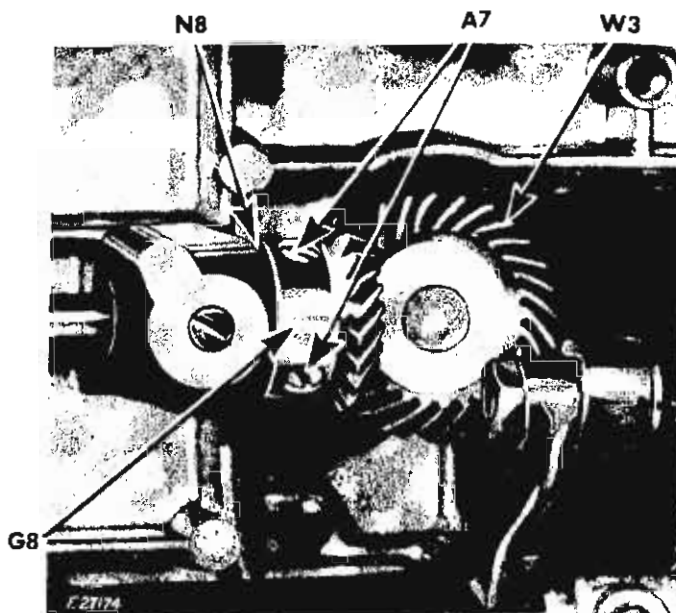

Fig. 298. Adjustment for Hook Timing

At this position of needle bar, point of rotating hook should be at center of needle, as shown in Fig. 297.

SETTING:

Loosen the two set screws **A7**, Fig. 298 in gear **G8**.

While maintaining position of needle bar, so that lower timing mark remains level with lower end of bushing **Z**, Fig. 297 turn gear **Y**, Fig. 299 A, page 144, on hook shaft, until hook point is located in position shown in Fig. 297.

Securely tighten two set screws **A7**, Fig. 298 making certain that gears **G8** and **W3**, Fig. 298 are **correctly meshed** without binding or back lash.

NOTE: Hub of gear **G8** should not bear against face of bushing at **N8**, Fig. 298.

Replace bottom cover, bobbin case, bed slide and throat plate.

PREPARATION:

Set needle bar at correct height, as instructed on page 134.

Time the needle vibrating mechanism, as instructed on pages 138 to 142.

Select a Size #18 needle, tested for straightness, and insert it correctly in needle bar.

Remove throat plate, bed slide and bobbin case.

Remove bottom cover. (Feed dog is removed in Fig. 297 to show point of hook, but it need not be removed to time the hook.)

Set red lever at #3 position and selector knobs at A and K, as shown in Fig. 295, page 142.

CHECK:

Turn hand wheel over toward operator until **LOWER** timing mark (see Fig. 297) is level with lower edge of needle bar ball bushing **Z**, Fig. 297, on upward stroke of needle bar.

TO SET THE POSITION OF THE HOOK POINT TO OR FROM THE NEEDLE

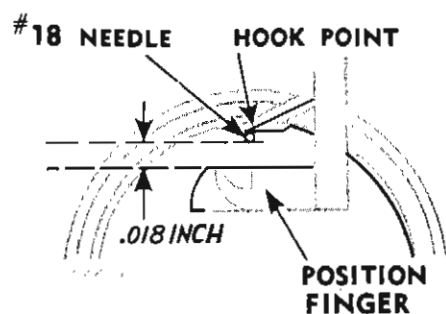

Fig. 299. Correct Position of Hook (Viewed from Above)

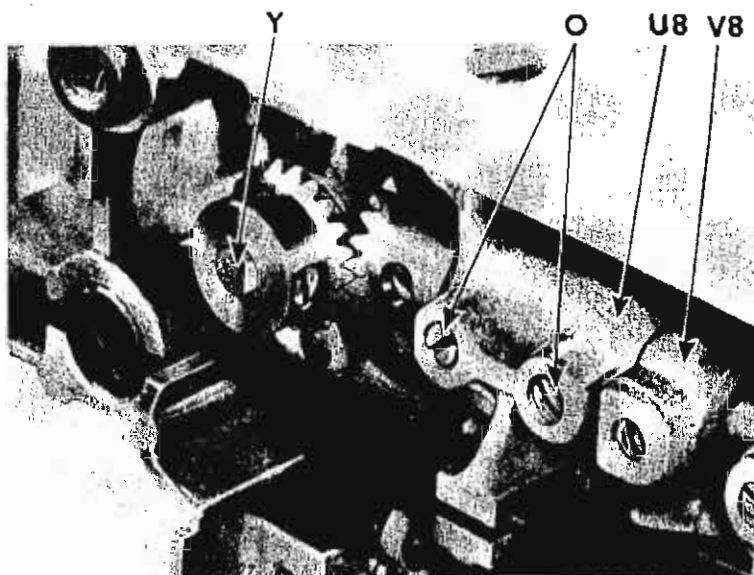

Fig. 299A. Setting the Hook

PREPARATION:

Set needle bar at correct height as instructed on page 133.

Set red lever at #1 position and stitch selector knobs at A and K.

Select a Size #18 needle, tested for straightness, and insert it correctly in needle bar.

CHECK:

Turn hand wheel over toward operator until point of hook is directly behind needle.

Distance between needle and position finger should be .018 inch, as shown in Fig. 299. (Use feeler gauge to check this distance.)

SETTING:

Loosen two screws O, Fig. 299A.

Move entire hook bracket assembly U8, Fig. 299A, over toward rear, moving hook point away from needle.

Place feeler gauge .018 inch, between needle and position finger.

Move hook bracket assembly U8 over toward front until correct setting is obtained.

Make certain that hook bracket U8 is snug against lug V8, Fig. 299A, on machine. Then securely tighten two screws O.

Check the timing of the hook, as instructed on page 143.

REMOVALS AND REPLACEMENTS UPRIGHT ARM SHAFT

CAUTION: DO NOT REMOVE the upright arm shaft, from this machine. If this becomes necessary, the machine should be returned to the factory.

Both sets of bevel gears at the ends of the upright arm shaft have been lapped together at the factory and should be kept in mesh throughout all other removals and replacements.

THE MOTOR

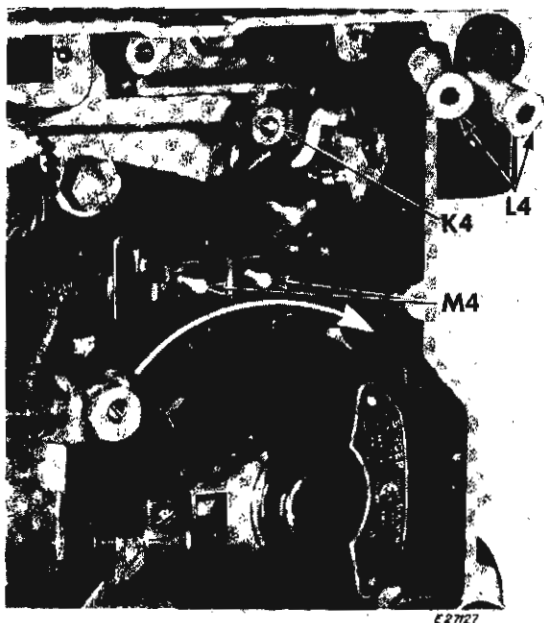

Fig. 300. Removing Motor

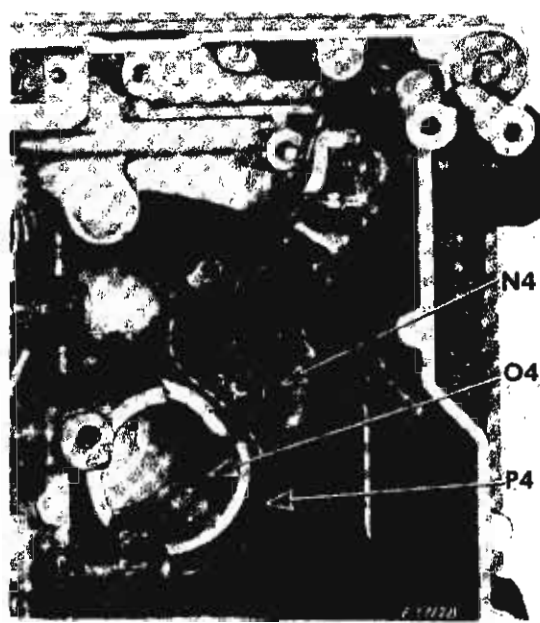

Fig. 301. Location of Wires around Motor

CAUTION:

Remove plug from electric outlet before removing any electrical part from machine.

REMOVAL:

1. Tilt machine back.
2. Remove bottom cover plate.
3. Remove motor hold-down plate, by removing screw from hole **K4**, Fig. 300.
4. Remove two electrical sleeve connections **L4** from motor terminals **M4**, Fig. 300.
5. Slide motor out toward you; rocking it from side to side to facilitate removal.

NOTE: Remove grit or hardened grease from worm gear on motor shaft, before replacing motor.

REPLACEMENT:

1. Make sure that wire **P4**, Fig. 301 is correctly located around and under cylindrical tube **O4**; then up behind three-pin terminal **N4**, as shown in Fig. 301.
2. Slide motor into position, turning hand wheel slightly to facilitate correct gear mesh. Push motor clockwise firmly until motor butts against casting, as shown by curved arrow in Fig. 300.
3. Fit electrical sleeve connections **L4**, Fig. 300 to terminals **M4**.
4. Replace motor hold-down plate and bottom cover plate.

NOTE: See Wiring Diagram on page 162.

REMOVALS AND REPLACEMENTS THE LIGHT FIXTURE

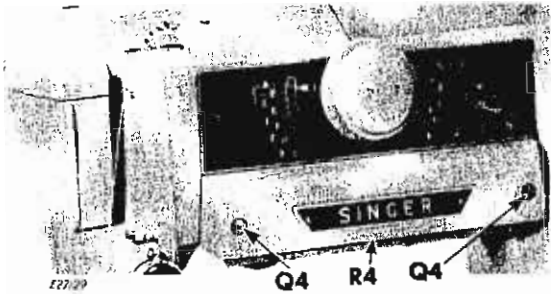

Fig. 302. Lamp Shade

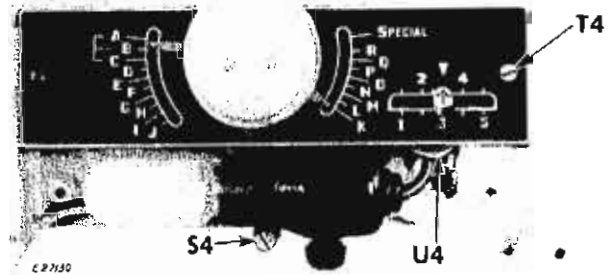

Fig. 303. Light Fixture

REMOVAL:

1. Remove two screws **Q4** and lamp shade **R4**, **Fig. 302**.
2. Remove screw **S4**, **Fig. 303** and allow light fixture to hang from arm.
3. Remove arm top cover.
4. Remove two wire connectors **W4**, **Fig. 304** and disengage light fixture wire from motor leads.
5. Lift oil shield **A5**, **Fig. 304** from arm casting.
6. Remove screw **T4** and lead clip **V4**, **Fig. 304**, **page 147**.
7. Disengage rubber grommet **U4**, **Fig. 303** from arm casting.
8. Remove light fixture with its leads and rubber grommet from machine.

REPLACEMENT:

1. Insert light fixture leads with rubber grommet up through hole provided for them in arm casting at **U4**, **Fig. 303**.
2. Install rubber grommet, as shown in **Fig. 303**.
3. Replace lead clip **V4** and fasten with screw **T4**, **Fig. 304**.
4. Replace oil shield **A5**, as shown in **Fig. 304**, **page 147**.
5. Connect one light fixture lead to each of the motor leads and cap with wire connectors **W4**, as shown in **Fig. 304**.
6. Replace arm top cover.
7. Replace light fixture and fasten with screw **S4**, **Fig. 303**.
8. Replace lamp shade **R4** and fasten with two screws **Q4**, **Fig. 302**.

REMOVALS AND REPLACEMENTS

WIRING HARNESS

(See Wiring Diagram on page 162.)

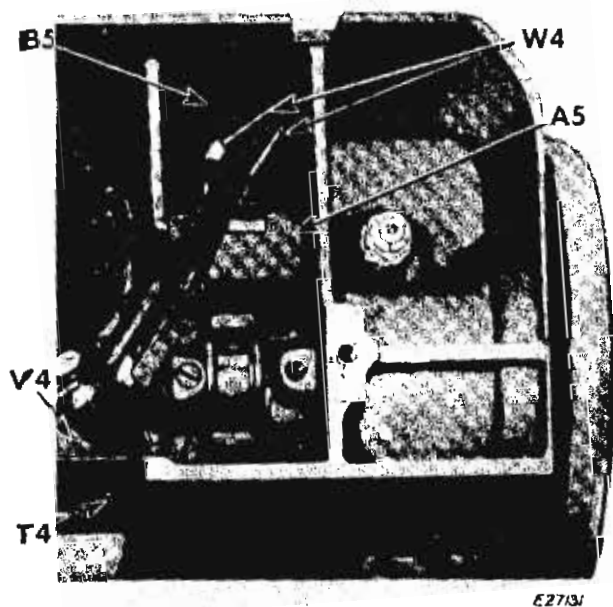

Fig. 304. Wiring at Top of Arm

REMOVAL:

1. Remove male-half of two-pin terminal **Z4**, Fig. 305.

2. Remove female-half of three-pin terminal **N4**, Fig. 305.

3. Remove motor and hold-down plate, as instructed on page 145.

4. Remove light fixture, as instructed on page 146.

5. Remove two screws **X4**, Fig. 305.

6. Loosen two screws **Y4**, Fig. 305 and push female-half of two-pin terminal into recess beneath bed of machine.

7. Remove two-pin terminal and wire leads through hole in arm provided for three-pin terminal.

REPLACEMENT:

1. Install both terminals with their wire leads in machine, as shown in Fig. 305.

2. Insert sewing light leads up through cavity provided for them in machine arm, as shown at **B5**, Fig. 305.

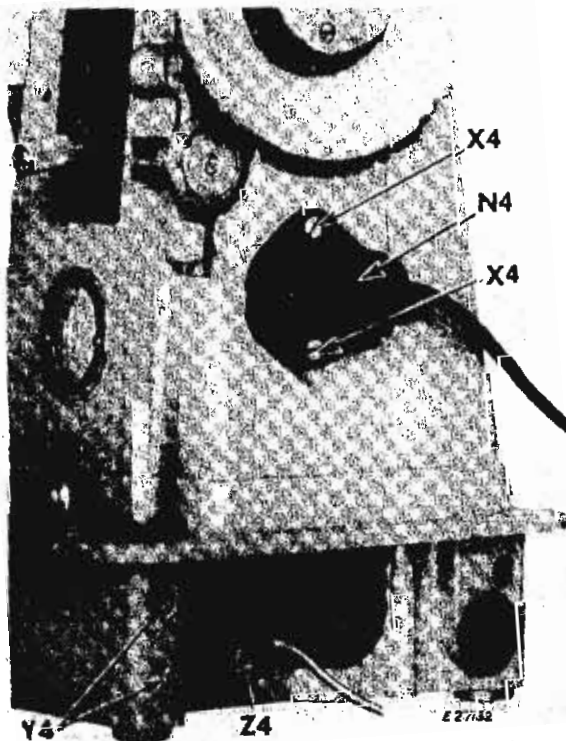

Fig. 305. Terminal Blocks

NOTE: Make certain that light leads are above the three-pin terminal and around the cylindrical tube, as shown in Fig. 301, page 145 and instructed in Step #1 under "REPLACEMENT" on page 145.

3. Fasten male-half of three-pin terminal **N4** to machine with two screws **X4**.

4. Fasten female-half of two-pin terminal **Z4** to machine with two screws **Y4**.

5. Replace light fixture, as instructed on page 146.

6. Replace motor and hold-down plate, as instructed on page 145.

7. Replace female-half of three-pin terminal at **N4**, Fig. 305.

8. Replace male-half of two-pin terminal at **Z4**, Fig. 305.

REMOVALS AND REPLACEMENTS NEEDLE THREAD TENSION

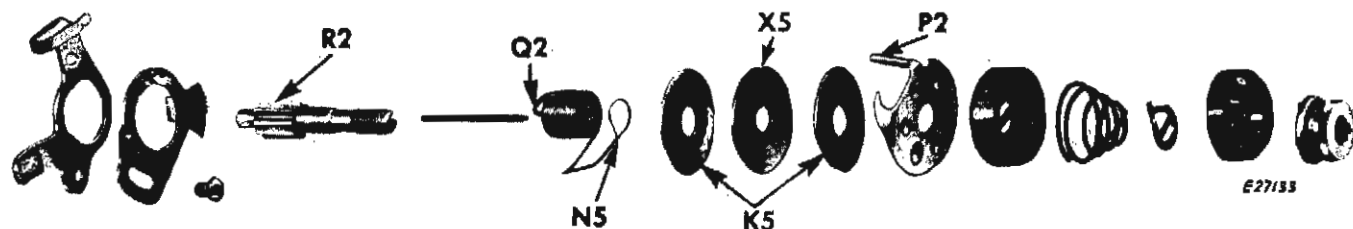

Fig. 306. Needle Thread Tension — Exploded View

REMOVAL:

1. Turn thumb nut **L5**, Fig. 307 to left (counter-clockwise) until "0" on numbered dial **D5** stops at center line on indicator **G5**, Fig. 307.
2. Press in dial **D5**, separating pin **C5** in thumb nut **L5** from hole in dial **D5**; unscrew thumb nut **L5** and remove it from stud **Q2**, Fig. 307.

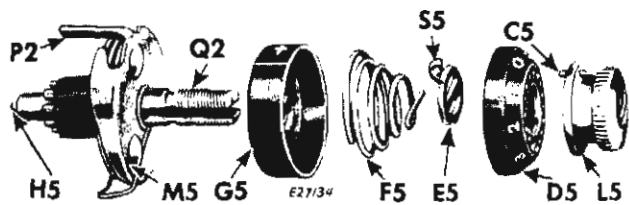

Fig. 307. Needle Thread Tension
Disassembled

NOTE: It is not necessary to remove stud **Q2** from machine to disassemble the thread tension. It is shown removed in Figs. 306 and 307, to illustrate complete assembly. See page 132 for instructions on removal and replacement of entire tension assembly.

3. Other parts may be removed from the stud **Q2** in the order which they are shown in Figs. 306 and 307.

REPLACEMENT:

1. Replace parts on stud **Q2** in the order in which they are shown in Figs. 306 and 307.
2. Make certain that tension releasing pin **H5** is in place as shown in Fig. 307.
3. Place the two tension discs **K5** with their convex faces against flat disc **X5** in center, as shown in Fig. 306. These three tension discs should be behind thread take-up spring thread guard **M5**, as shown in Fig. 307.
4. Pass eyelet **N5**, Fig. 306 of take-up spring under thread guard, having coils of spring above tension discs, as shown in Fig. 308.

REMOVALS AND REPLACEMENTS NEEDLE THREAD TENSION (Continued)

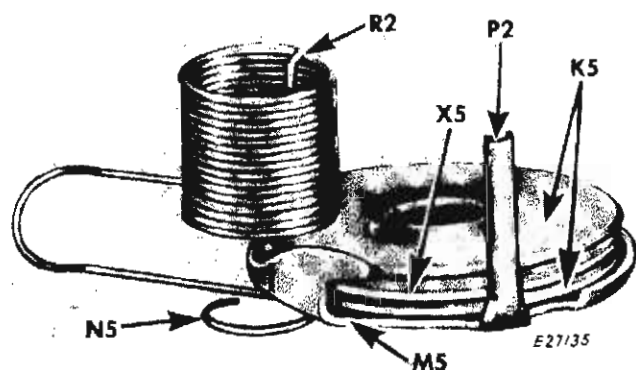

Fig. 308. Tension Disc Assembly

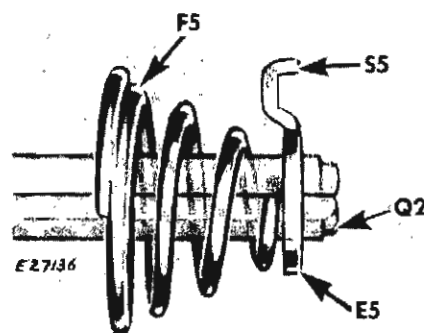

Fig. 309 Stop Washer and Tension Spring

5. Guide the tension disc assembly on the stud **Q2**, so that extension **P2**, **Figs. 306, 307 and 308** enters hole, provided for it in machine arm and so that the tail **R2**, **Fig. 308**, inside the spring coil, enters one of the grooves at the rear of the stud **Q2** (see also **page 132**).

6. Replace indicator **G5**, **Fig. 307** with its large open side facing the split end of the stud — with plus and minus mark on top — “minus” at left and “plus” at right.

7. Hold these assembled parts against shoulder of stud, insert tension spring **F5**, **Fig. 307** in indicator, with first half-coil of spring **F5** straddling lower half of split stud.

8. Guide the stop washer on the stud **Q2** so that extension **S5** will be above stud.

NOTE: When spring and stop washer are correctly assembled, extension **S5** will clear the first half-coil of the tension spring, as shown in **Fig. 309**.

9. Place the numbered dial **D5**, **Fig. 307** so that the number “2” is opposite stop washer extension **S5**.

10. Push dial **D5** to compress spring to facilitate replacement of thumb nut **L5**.

11. Replace thumb nut **L5**, carefully guiding pin **C5** into one of the holes in dial **D5**.

12. Adjust assembly as instructed on **pages 132 and 133**.

REMOVALS AND REPLACEMENTS HAND WHEEL AND COUNTERBALANCE

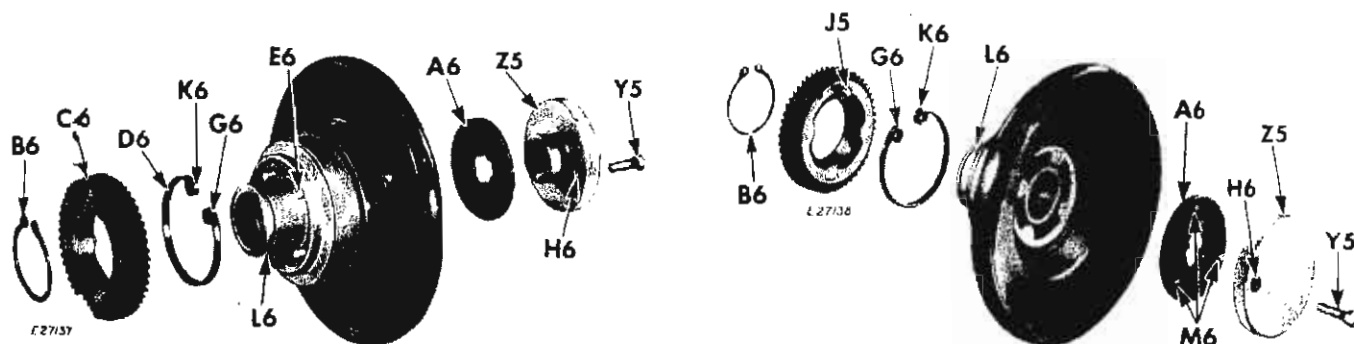

Fig. 310. Exploded Views of Hand Wheel Assembly

REMOVAL AND DISASSEMBLY:

1. Remove small screw **Y5** from stop motion nut **Z5**, Fig. 310.
2. Remove nut **Z5** and clamp washer **A6** from arm shaft.
3. Remove hand wheel assembly from arm shaft.
4. Remove screw **P5** and counterbalance **O5**, Fig. 311 from arm shaft.
5. Remove hand wheel snap ring **B6**, Fig. 310 from hand wheel assembly with expansion pliers.
6. Slip gear **C6** from hand wheel.

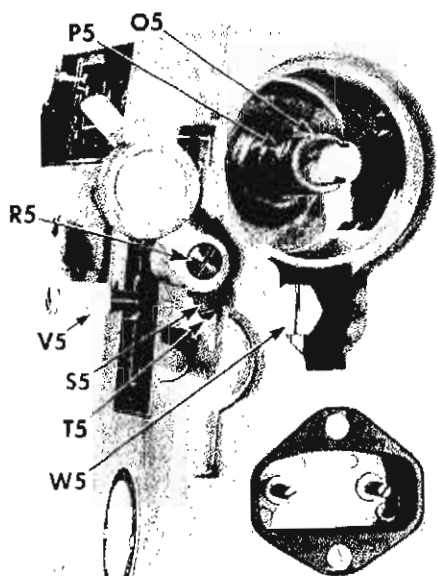

Fig. 311. Arm Shaft Counterbalance

7. Remove gear spring **D6**, Fig. 310 from stud **E6** of hand wheel.

ASSEMBLY AND REPLACEMENT:

1. Place gear spring **D6**, Fig. 310 into hand wheel so that loop **G6** of spring grasps middle stud **E6**, Fig. 310 in hand wheel.
2. Place gear **C6** on hand wheel, with stud **J5** inserted in loop **K6**, Fig. 310 of gear spring.
3. Replace snap ring **B6** on hand wheel, setting ring in groove **L6**, Fig. 310 on hand wheel sleeve.
4. Replace counterbalance **O5**, Fig. 311.
5. Insert screw **P5** through counterbalance **O5** and hole provided for it on arm shaft, as shown in Fig. 311.

6. Replace hand wheel assembly on arm shaft.
7. Replace stop motion clamp washer **A6**, Fig. 310 (three short studs **M6** facing outward).
8. Replace and tighten stop motion nut **Z5** and replace screw **Y5** in hole **H6**, Fig. 310, in stop motion nut.

NOTE: If studs **M6** interfere with screw **Y5** when stop motion nut **Z5** is loosened to release hand wheel, remove screw **Y5** and nut **Z5**. Remove washer **A6**, rotate it 180° and replace it on arm shaft. Replace nut **Z5** and screw **Y5**.

REMOVALS AND REPLACEMENTS

BOBBIN WINDER

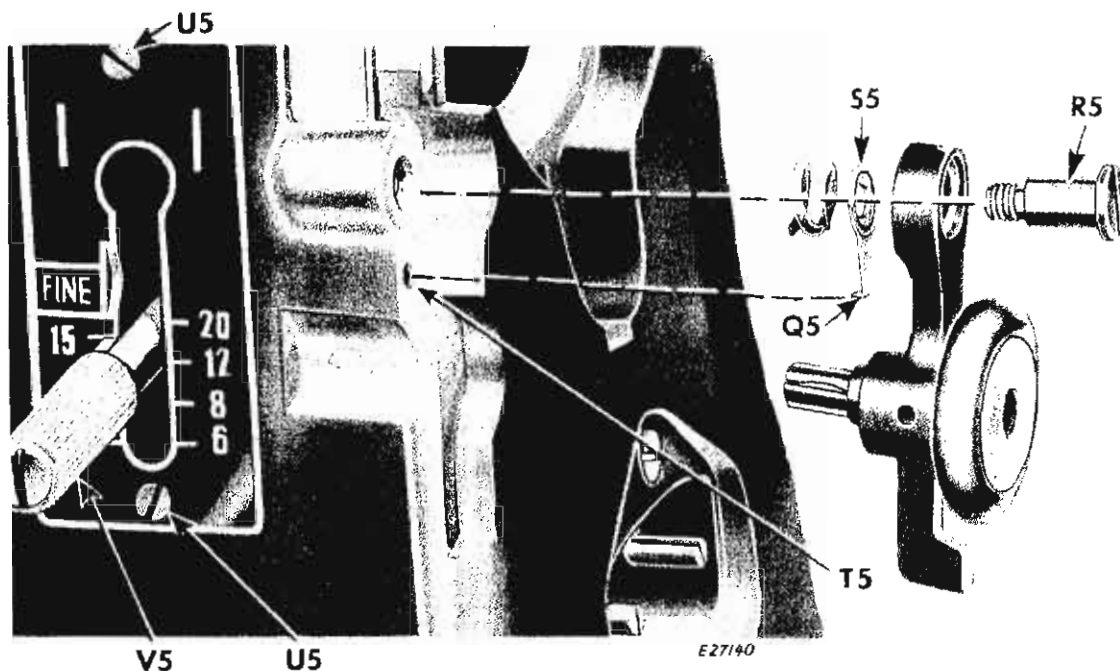

Fig. 312. Bobbin Winder Removed

REMOVAL AND DISASSEMBLY:

1. Remove hand wheel, as instructed on page 150.
2. Remove screw **R5**, Fig. 312.
3. Disassemble as shown in Fig. 312.

ASSEMBLY AND REPLACEMENT:

1. Assemble in order indicated in Fig. 312.

2. Replace bobbin winder on machine arm, fastening it to machine arm by means of hinge screw **R5**.

3. Make sure that projection **Q5** on frame spring **S5** is inserted in hole **T5** in machine arm.

4. Tighten hinge screw **R5**.

5. Replace hand wheel as instructed on page 150.

STITCH REGULATOR

REMOVAL:

1. Remove hand wheel, as instructed on page 150.
2. Remove two screws **U5**, Fig. 312, holding stitch regulator plate.
3. Move feed regulator **V5**, Fig. 312 to bottom of slot in indicator plate.
4. Remove large screw stud **W5**, Fig. 311 with its spring and washer from arm casting.
5. Pull entire regulator, with stitch plate out the front of the machine arm.

REPLACEMENT:

1. Install regulator **V5**, Fig. 312 in arm, making certain that slide fits on block on feed fork connection.
2. Replace large stud **W5**, Fig. 311 with spring and washer, so that stud holds slide to inside of arm.
3. Set indicator plate in position on front of machine arm and replace two screws **U5**.
4. Tighten screws **U5**.
5. Replace hand wheel, as instructed on page 150.

REMOVALS AND REPLACEMENTS

THROAT PLATE POSITION BRACKET

(See Figs. 313 and 314)

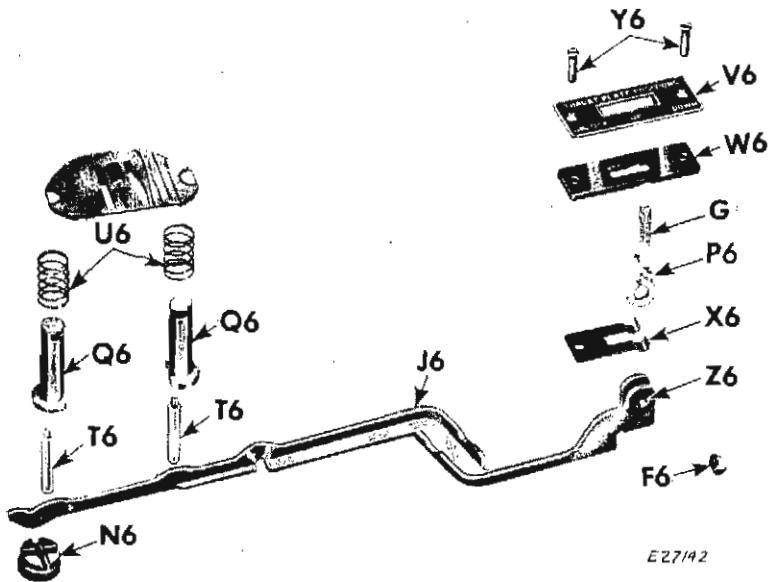

Fig. 313. Exploded View of Throat Plate Position Bracket

REMOVAL:

1. Remove bottom cover plate.
2. Remove throat plate.
3. Set position lever **G** in "down" position and while pressing left hand end of bracket **J6** toward underside of machine bed, remove adjusting screw **N6**.

4. Swing bracket **J6** outward, away from machine bed and remove two throat plate clamps **Q6** with pins **T6** and springs **U6** from machine.

5. Set position lever **G** in "up" position, as shown in inset at right of Fig. 314, and remove screw **F6** at front of machine bed.

6. Remove bracket **J6**.

7. Remove two screws **Y6** at top of indicator plate **V6**.

8. Lift indicator plate **V6**, stop plate **W6**, spring **X6** and lever **G**, from bed of machine.

REPLACEMENT:

Replace throat plate position bracket in the reverse order of its removal. Observe the following —

Lever **G** and spring **X6** should be replaced with the curved portions of spring under cross-piece **P6** of lever **G**. (Remainder of spring should extend toward left).

Hole **Z6** of bracket **J6** should be aligned with hole at bottom of lever **G** and with hole in front of machine bed, as shown in inset at top right of Fig. 314. Then fasten lever to bracket with screw **F6**.

Bracket **J6** must be inserted in grooves **R6** under machine bed, as shown in Fig. 314.

Adjusting screw **N6** should be tightened flush with bottom of casting, as shown in Fig. 314.

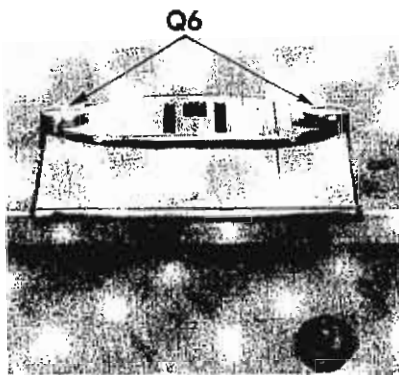
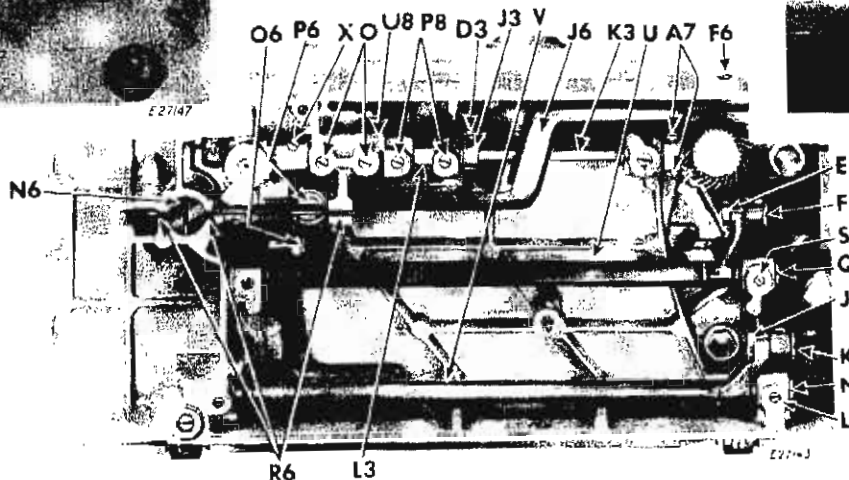
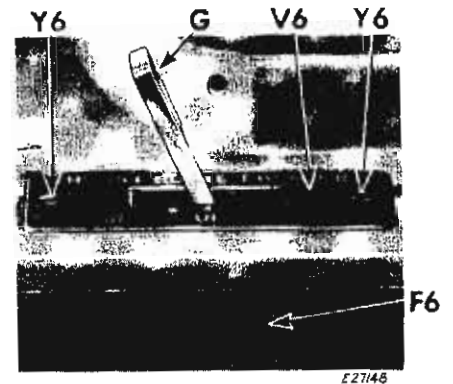

Fig. 314. Throat Plate Position Bracket Assembled



REMOVALS AND REPLACEMENTS

FEED LIFTING ROCK SHAFT

(See Fig. 314, page 152)

REMOVAL:

1. Remove bottom cover plate.
2. Remove motor hold-down plate and motor as instructed on **page 145**.
3. Remove nut **E** and eccentric **F**, **Fig. 314**, disengaging feed lifting rock shaft **U** from upright connecting rod.
4. Loosen set screw **S** and remove screw center **Q**.

5. Remove screw stud **O6**, disengaging feed bar.
6. Remove feed lifting rock shaft **U**.

REPLACEMENT:

1. Install feed lifting rock shaft **U** in reverse order instructed for removal.
2. Adjust feed dog, as instructed on **pages 129, 130 and 136**.
3. Replace motor, as instructed on **page 145**.

FEED ROCK SHAFT ASSEMBLY

(See Fig. 314, page 152)

REMOVAL:

1. Remove bottom cover plate.
2. Remove motor hold-down plate and motor, as instructed on **page 145**.
3. Remove feed lifting rock shaft **U**, as instructed above.
4. Remove nut **J**, **Fig. 314**.
5. Remove eccentric **K**, disengaging feed rock shaft **V** from feed fork connection.
6. Loosen set screw **L** and remove screw center **N**.

7. Remove feed rock shaft **V** with feed bar and feed dog.

REPLACEMENT:

1. Install feed rock shaft **V** with feed bar and feed dog in reverse order instructed for removal.
2. Install feed lifting rock shaft **U**, as instructed above.
3. Adjust feed dog, as instructed on **pages 129, 130 and 136**.
4. Replace motor, as instructed on **page 145**.

HOOK DRIVING SHAFT

(See Fig. 314, page 152)

REMOVAL:

1. Remove rotating hook as instructed on **page 154**.
 2. Loosen set screw **D3**, **Fig. 314** on collar **J3**.
 3. Loosen two set screws **A7** in bevel gear.
- NOTE: KEEP THIS GEAR IN MESH WITH MATED GEAR ON UPRIGHT ARM SHAFT.**
4. Remove motor, as instructed on **page 145**.
 5. Remove two-pin terminal, as instructed on **page 147**.
 6. Loosen set screw **X** and remove gear from left end of hook driving shaft.

7. Slide shaft **K3** toward right and out of machine through hole provided for two-pin terminal in bed of machine.

REPLACEMENT:

1. Replace hook driving shaft in reverse order of its removal.

NOTE: Flat on shaft **K3** must be toward left end of machine (hook bracket end), so that set screw **X**, **Fig. 315** may be fastened upon it.

2. Replace hook as instructed on **page 154**.
3. Adjust and time hook assembly, as instructed on **pages 136, 143 and 144**.

REMOVALS AND REPLACEMENTS

CAUTION: Hook shaft gear Y, Fig. 315, and hand wheel gear C6, Fig. 310, page 150, may be removed to facilitate adjustments. **DO NOT DISTURB THE MESH OF ANY OTHER GEAR IN THIS MACHINE.** All other gears are mated and correctly timed. Replacements should be made at the factory.

ROTATING HOOK AND POSITION FINGER

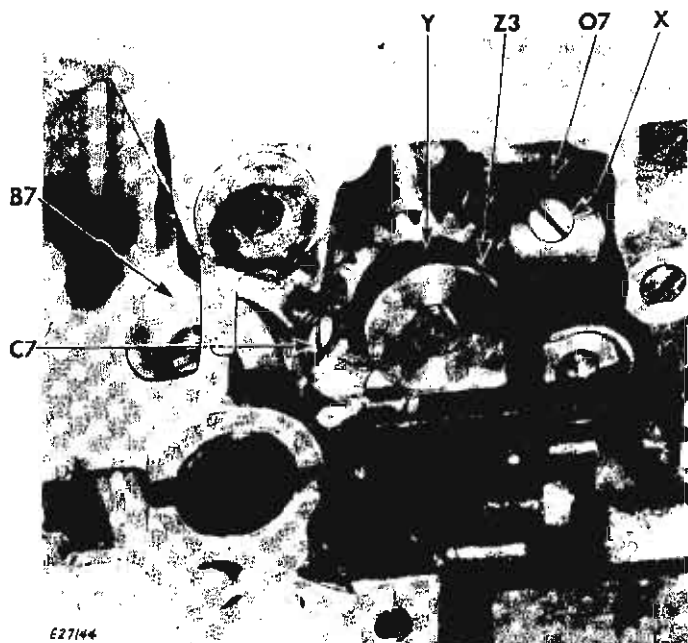

Fig. 315. Hook Shaft Bevel Gears

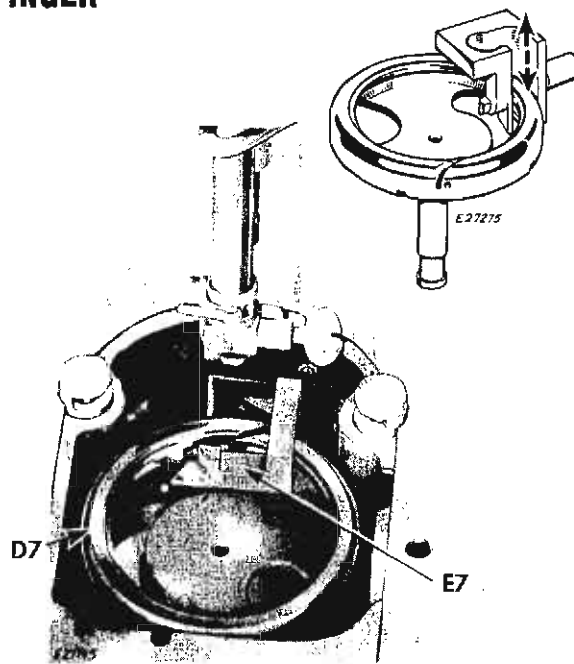

Fig. 316. Rotating Hook

REMOVAL:

1. Remove needle, presser foot, throat plate, bed slide, bobbin case, feed dog and cushion spring bracket.

2. Remove bottom cover plate.

3. **Mark the two bevel gears Y and O7, Fig. 315, with chalk or crayon, on one tooth of one gear and the corresponding space for that tooth between the teeth of the other gear, to facilitate re-assembly.**

4. Loosen set screw Z3, Fig. 315.

5. Remove bevel gear Y from hook shaft.

6. Insert screwdriver through hole B7, Fig. 315, and loosen set screw C7.

7. Remove rotating hook assembly D7, Fig. 316.

8. Remove position finger from hook, as shown in inset at top right corner of Fig. 316. **Keep position finger away from hook point.**

REPLACEMENT:

1. Install position finger E7 on hook, as shown in Fig. 316. Slide position finger down and around ring on hook at point shown in inset at top right cor-

ner of Fig. 316 keeping it away from hook point. Then move position finger to correct position at E7, Fig. 316.

2. Install rotating hook assembly D7 with position finger E7, as shown in Fig. 316.

3. Press down on finger E7 and tighten set screw C7.

4. Replace bevel gear Y on hook shaft.

5. Using marks, previously made at removal, as a guide, mesh the two hook shaft bevel gears Y and O7.

6. Turn hook shaft until flat is under set screw Z3 in gear Y and tighten screw Z3.

NOTE: The two set screws X and Z3 on the two bevel gears should be in line when hook shaft and hook driving shaft are correctly installed.

7. Check and adjust hook, as instructed on pages 136, 143 and 144.

8. Replace bottom cover plate.

9. Replace cushion spring bracket, feed dog, bobbin case, bed slide, throat plate, presser foot and needle.

REMOVALS AND REPLACEMENTS

FEED LIFTING ROCK SHAFT CONNECTING ROD

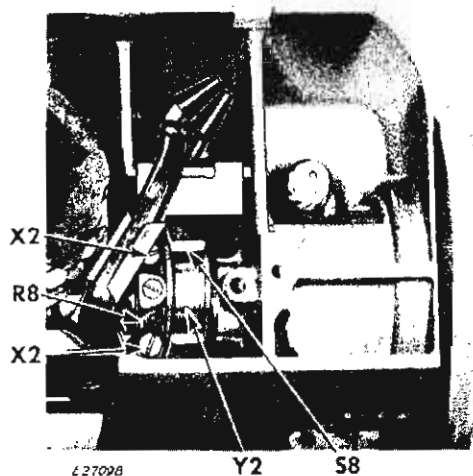

Fig. 317. Feed Lifting Connecting Rod on Arm Shaft

REMOVAL:

1. Remove arm top cover.
2. Remove two cap screws **X2**, Fig. 317 and remove connecting rod cap **R8**, Fig. 317.
3. Remove bottom cover plate and motor, as instructed on page 145.
4. Remove nut **E** and eccentric stud **F**, Fig. 318, disengaging connecting rod **Q8** from feed lifting rock shaft **U**, Fig. 318.
5. Remove connecting rod **Q8** from bottom of machine.

REPLACEMENT:

1. Insert connecting rod **Q8**, Fig. 318 into upright arm through bottom of machine, so that it fits around bottom half of gear hub on eccentric **Y2**,

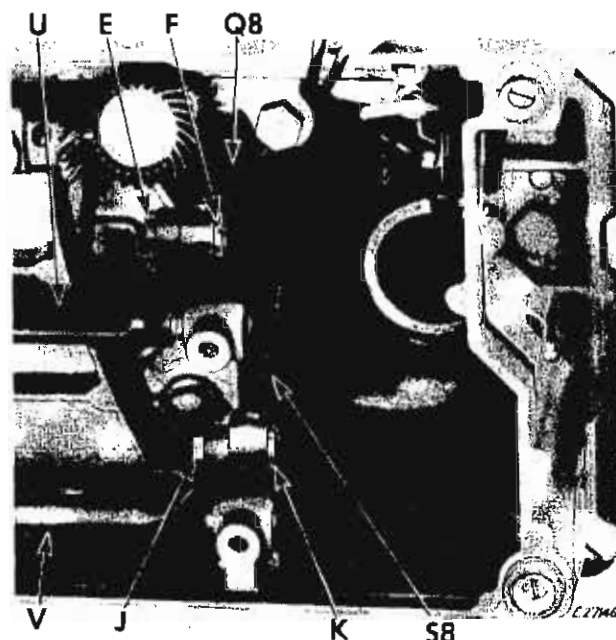

Fig. 318. Connections beneath Machine Bed

Fig. 317 and so that the oil hole in the lower end the rod faces the front edge of machine bed.

2. Replace cap **R8** over top half of gear hub and fasten cap to rod with two screws **X2**, Fig. 317.
3. Replace stud **F** and nut **E**, Fig. 318, engaging connecting rod **Q8** to shaft **U**.
4. Adjust feed dog height, as instructed on page 129.
5. Replace motor and bottom cover plate, as instructed on page 145.
6. Replace arm top cover.

FEED FORKED CONNECTION

REMOVAL:

1. Remove stitch regulator, as instructed on page 151.
2. Remove motor, as instructed on page 145.
3. Remove nut **J** and stud **K**, Fig. 318, disengaging feed forked connection **S8** from feed rock shaft **V**, Fig. 318.
4. Remove feed forked connection **S8** from upright arm, through bottom of machine.

REPLACEMENT:

1. Insert feed forked connection **S8** into upright

arm, through bottom of machine, so that it fits around eccentric **Y2** from bottom, as shown in Fig. 317.

2. Engage feed forked connection **S8** with feed rock shaft **V**, Fig. 318 and fasten with stud **K** and nut **J**.
3. Replace stitch regulator, as instructed on page 151.
4. Adjust position of feed dog, as instructed at bottom of page 129.
5. Replace motor, as instructed on page 145.

REMOVALS AND REPLACEMENTS

NEEDLE BAR

(See Fig. 319)

REMOVAL:

1. Remove needle clamp and needle clamp thread guide.
2. Remove arm top cover and face plate.
3. Loosen screw **W** and lift needle bar **J7**, up through bushings and out of machine.

REPLACEMENT:

1. Insert needle bar down through bushings, as shown in Fig. 319.
2. Replace needle clamp, needle clamp thread guide, and face plate.
3. Adjust needle bar height, as instructed on page 133.
4. Securely tighten set screw **W**.
5. Replace face plate and arm top cover.

PRESSER BAR

(See Fig. 319)

REMOVAL:

1. Open the face plate.
2. Remove presser foot and thumb screw.
3. Remove pressure regulating thumb screw **U2**.
4. Remove extension pin **M7** and extension pin seat **K7**.
5. Loosen set screw **C**, and remove presser bar guide bracket **L7**.
6. Loosen screw **A3** and remove presser bar bushing **B3**, lower thread guide **C3** and presser bar **D**.

REPLACEMENT:

1. Replace presser bar assembly in the reverse order of its removal.

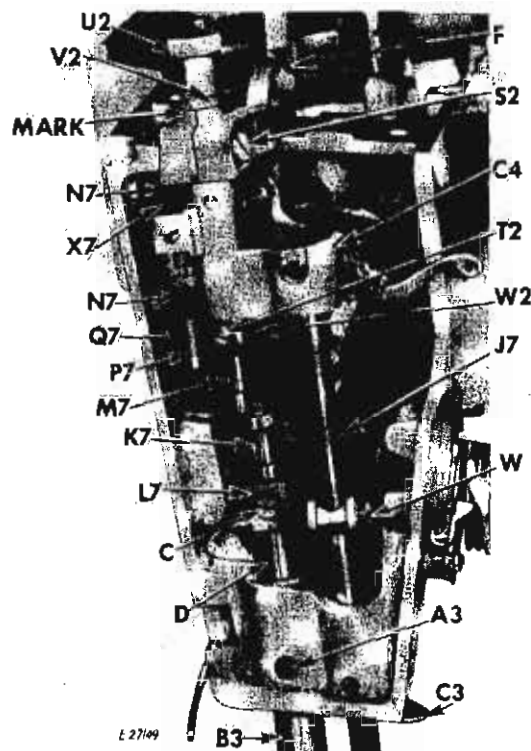

Fig. 319. Needle Bar Assembly

2. Replace thread guide **C3**, as instructed on page 135.
3. Replace presser foot and presser foot thumb screw.
4. Replace pressure regulating thumb screw **U2**, Fig. 319.
5. Adjust presser foot at correct height, as instructed on page 128.
6. Align presser foot with slots for feed dog in throat plate, as instructed on page 128, and securely tighten set screw **C**, Fig. 319.

NEEDLE BAR VIBRATING BRACKET

(See Fig. 319)

REMOVAL:

1. Remove arm top cover and face plate.

2. Remove thumb screw **U2**.
3. Remove extension pin **M7**.

4. Mark edge of eccentric hinge pin **V2** as shown in **Figs. 319** and **320** so that its position in relation to casting may be readily regained.

5. Unhook spring **P7** from hinge pin **Q7**, **Fig. 320**.

6. Loosen screw **K9**, **Fig. 320** and remove pin **Q7**.

7. Loosen set screw **T2** and remove collar **W2**, **Fig. 320**.

8. Loosen clamping screw **S2** and remove large, eccentric hinge pin **V2**.

9. Remove needle bar vibrating bracket **C4** from machine head.

REPLACEMENT:

Install needle bar vibrating bracket **C4** in the reverse order of its removal. Observe the following —

Spring **P7** must be hooked around hinge pin **Q7**, as shown in **Fig. 320**.

Make certain that when set screw **T2** is tightened, bracket **C4** moves without looseness or binding.

Turn hinge pin **V2** so that marks made in Step 4 of "Removal" coincide. Then securely tighten clamping screw **S2**.

NEEDLE THREAD TAKE-UP

REMOVAL:

1. Remove arm top cover and face plate.

2. Remove needle bar vibrating bracket, as instructed on **page 156** and above.

3. Loosen set screw **H7**, **Fig. 320** over hinge stud **R7**.

4. Loosen small set screw **F7** in needle bar crank **S7**, through hole in top of casting, as shown in **Fig. 320**.

5. Withdraw needle thread take-up **T7**, with link **U7**, hinge stud **R7** and stud **V7**, **Fig. 320** from machine head.

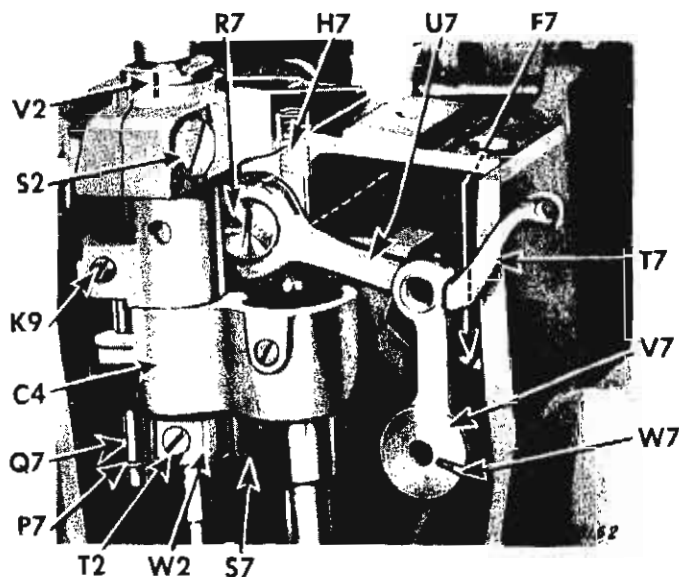

Fig. 320. Needle Thread Take-up

REPLACEMENT:

1. Install needle thread take-up in reverse order of its removal, outlined above.

2. Locate mark **W7** on stud **V7**, as shown in **Fig. 320**, in relation to its set screw **F7**. Press firmly upon stud **V7** and tighten set screw **F7**.

3. Turn hand wheel while setting hinge stud **R7**, to make sure there is no end play nor binding; then tighten set screw **H7**, **Fig. 320**.

4. Replace needle bar vibrating bracket as instructed above.

5. Replace arm top cover and face plate.

REMOVALS AND REPLACEMENTS CAM STACK

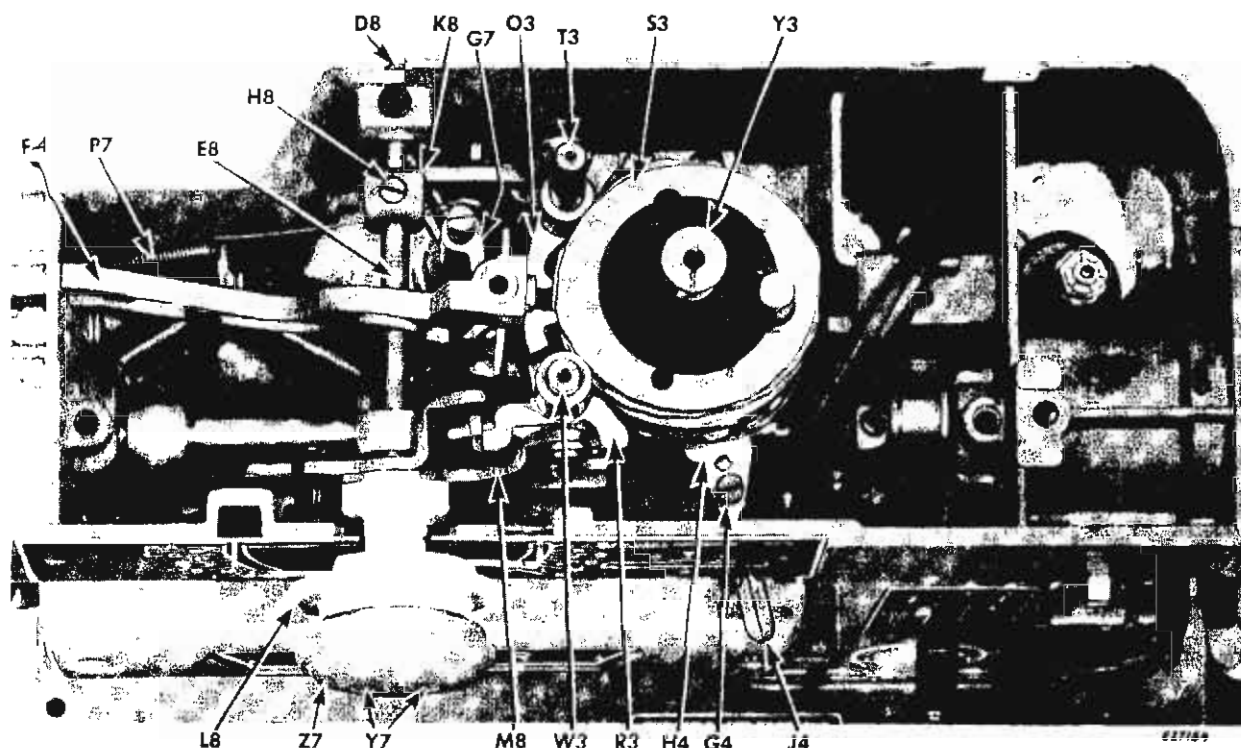

Fig. 321. Cam Stack and Selector Arm Shaft

REMOVAL:

1. Set stitch selector knobs at **A** and **K**, as shown in Fig. 295, page 142.
2. Remove arm top cover and special disc.
3. Remove large screw stud **Y3**, Fig. 321 with spring and remove cam stack **S3**.

REPLACEMENT:

1. Replace cam stack, meshing it with worm gear on arm shaft, by working it back and forth.
2. Replace screw stud **Y3** and spring.
3. Replace special disc and arm top cover.

CAM SELECTOR ARM SHAFT AND FOLLOWERS

REMOVAL:

1. Remove cam stack, as instructed above.
2. Remove two screws **Y7** and knob **Z7**, Fig. 321.
3. Remove screw **A8**, indicator **B8** and spring **C8**, Fig. 322.
4. Remove screw **D8**, Fig. 321, at rear of selector arm shaft **E8**.
5. Remove screw **H8** and withdraw shaft **E8** from front of arm, releasing rear selector arm **K8**, and front selector arm and knob **L8**, Fig. 321.
6. Withdraw knob **L8** from machine.
7. Remove followers **O3** and **R3**, Fig. 321.

REPLACEMENT:

1. Replace followers **O3** and **R3**, as shown in Fig. 321.
2. Replace knob **L8** so that bracket on front selector arm **M8** slides into its slot in front follower **R3**, Fig. 321.
3. Replace selector arm shaft **E8** slipping it through front selector arm knob **L8** and rear selector arm **K8**, Fig. 321. Make certain that bracket on rear selector arm **K8** slides into its slot in follower **O3**.

4. Replace and securely tighten screw **H8**, Fig. 321 so that screw clamps down on counterbore on shaft.
5. Replace spring **C8** and indicator **B8**, Fig. 322. Fasten with screw **A8**, Fig. 322.
6. Replace screw **D8**, Fig. 321 on rear of arm selector shaft.
7. Replace knob **Y7**, Fig. 321. Fasten knob to indicator **B8**, Fig. 322 with two screws **Z7**, Fig. 321.
8. Replace cam stack, as instructed above.

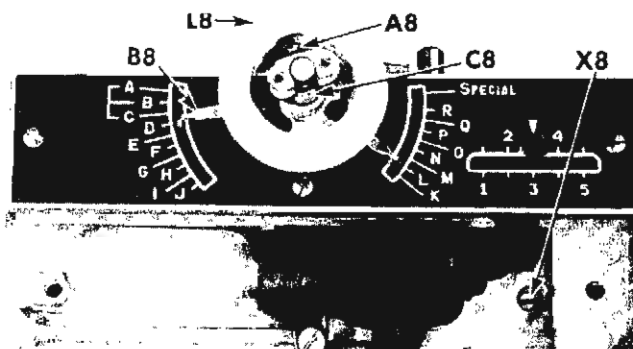

Fig. 322. Removing Selector Arm Shaft

REMOVALS AND REPLACEMENTS

NEEDLE BAR DRIVING ARM

REMOVAL:

1. Remove arm top cover and face plate.
2. Remove cam selector arm shaft, as instructed on **page 158**.
3. Remove needle bar vibrating bracket, as instructed on **pages 156 and 157**.
4. Lift needle bar driving arm, **F4**, **Fig. 323** from machine.

REPLACEMENT:

1. Install needle bar driving arm **F4** in arm of

machine, so that ball pivot **Z8**, **Fig. 323** rides in socket provided for it in pattern selector **Y8**, as shown in **Fig. 323**.

CAUTION: Make certain tension arm **G7**, **Fig. 323** is in correct position in relation to needle bar driving arm, as shown in **Fig. 323**.

2. Replace cam selector arm shaft as instructed on **page 158**.

3. Replace needle bar vibrating bracket, as instructed on **page 157**.

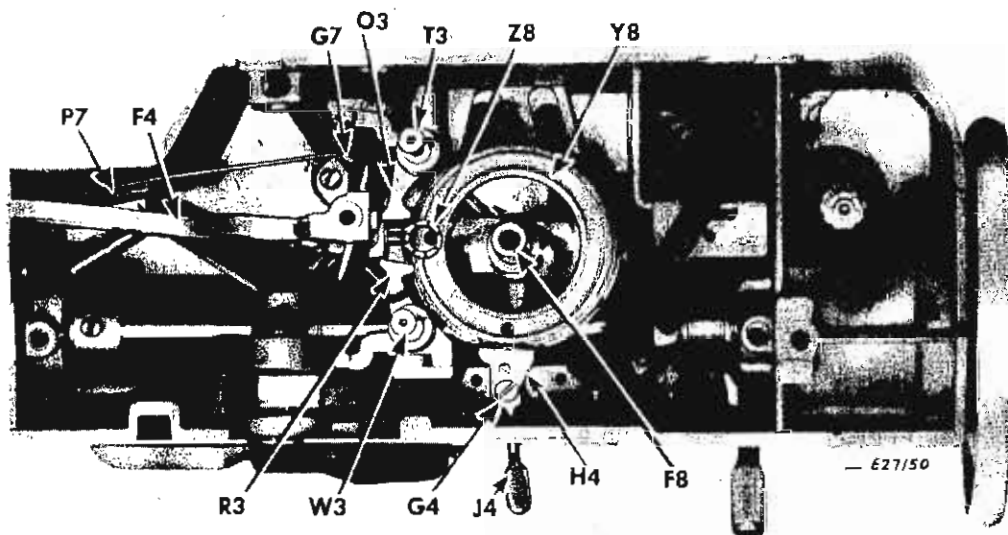

Fig. 323. Showing Location of Ball Pivot on Driving Arm

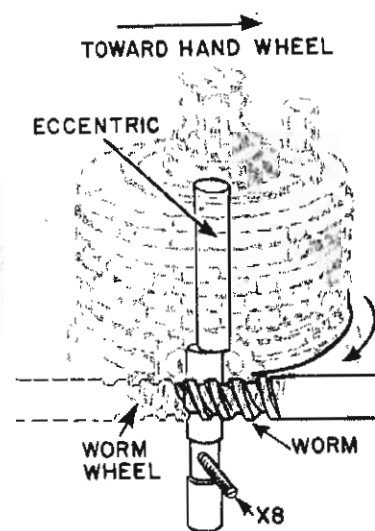

Fig. 323A. Eccentric Worm Wheel Shaft and Worm Wheel

BIGHT AMPLITUDE AND PATTERN SELECTOR

(See Fig. 323)

REMOVAL:

1. Remove arm top cover, face plate and lamp shade.
2. Set stitch selector knobs at **A** and **K** as shown in **Fig. 295, page 142**.
3. Remove spring **P7**, **Fig. 323**.
4. Remove screw **G4** from bight amplitude bracket **H4**.
5. Remove red lever **J4**.
6. Loosen set screw **X8**, **Fig. 322, page 158** and remove entire cam stack assembly **S3** with worm wheel eccentric shaft **F8**, **Fig. 323** and screw stud **Y3**, **Fig. 321, page 158**.
7. Remove bight amplitude and pattern selector **Y8** from machine arm.

REPLACEMENT:

Replace bight amplitude and pattern selector in the reverse order of its removal. Observe the following —

1. Assemble cam stack as a complete unit to machine. Upper eccentric half of eccentric worm wheel shaft **F8** should be turned toward the hand wheel end of shaft, as shown in **Fig. 323A**.

2. Make certain that needle bar driving arm ball bearing pivot **Z8** is engaged with pattern selector, as shown in **Fig. 323**.

3. Set mesh between worm and worm wheel by turning shaft **F8** clockwise until worm and worm wheel are engaged.

4. Turn shaft **F8** so that there is no binding when arm shaft is rotated and there is a minimum amount of back lash between worm and worm wheel.

5. Tighten set screw **X8**, **Fig. 322** at front of machine arm.

6. Replace spring **P7**, **Fig. 323**.

7. Replace lever **J4** and screw **G4**.

8. Adjust machine, as instructed on **page 141**.

9. Replace face plate, arm top cover and lamp shade.

REMOVALS AND REPLACEMENTS HORIZONTAL ARM SHAFT

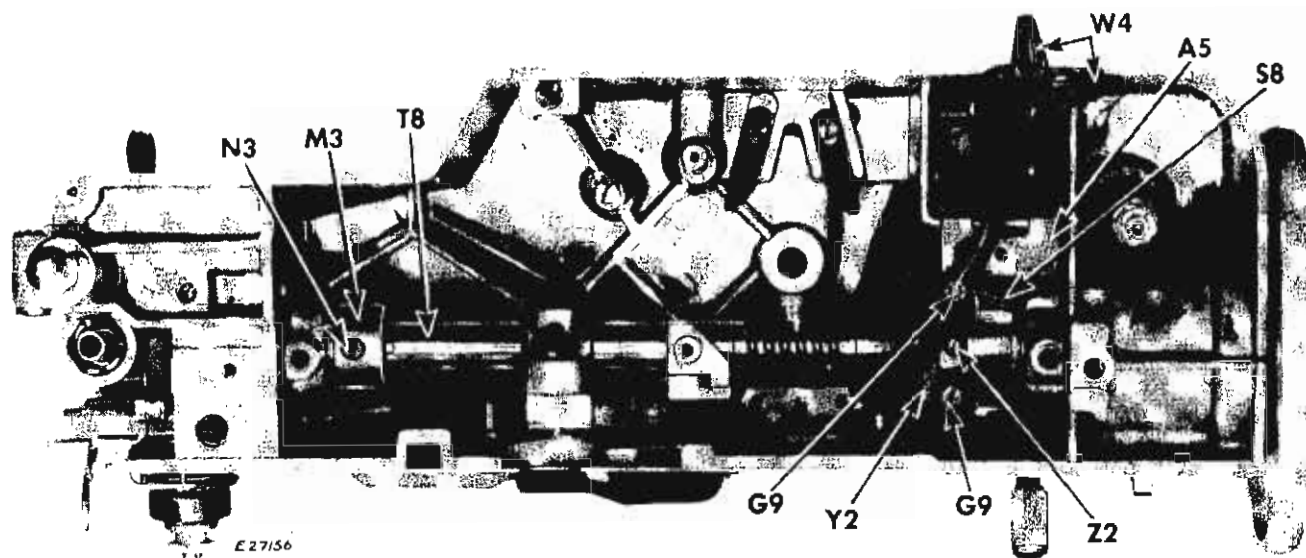

Fig. 324. Horizontal Arm Shaft

REMOVAL: (See "CAUTION" at top of page 154.)

1. Remove arm top cover and face plate.
2. Remove needle bar vibrating bracket and needle thread take-up, as instructed on pages 156 and 157.
3. Remove cam stack, as instructed on page 158.
4. Remove hand wheel and counter-balance, as instructed on page 150.
5. Remove wire connectors **W4**, disengaging motor leads from light leads.
6. Lift oil shield **A5** from arm casting.
7. Loosen screw **N3** in collar **M3**, Fig. 324.

NOTE: KEEP GEARS IN MESH AT ALL TIMES.

8. Remove two screws **G9** and remove connecting rod cap.
9. Using a 1/2 inch drift pin or another arm shaft (for Machine 401) drive arm shaft **T8**, Fig. 324, out of machine arm from **right to left**. Hold gear **Y2** in mesh with gear on upright arm shaft.

REPLACEMENT:

1. Insert a new arm shaft **T8**, Fig. 324, in head of machine at left end and push it into machine arm

from **left to right**, through collar **M3**, bevel-gear-and-eccentric **Y2** and feed forked connection **S8**, as shown in Fig. 324.

2. Make certain flat on arm shaft is under set screw **N3**, Fig. 324; then, while pressing firmly on needle bar crank, hold collar against casting and tighten set screw **N3**.
3. Make certain that feed timing screw **Z2** is over groove provided for it in arm shaft. Tighten screw **Z2**.
4. Replace connecting rod cap and fasten with two screws **G9**.
5. Replace oil shield **A5**, as shown in Fig. 324.
6. Connect motor leads to light leads and replace wire connectors **W4**, as shown in Fig. 324.
7. Replace hand wheel and counter-balance, as instructed on page 150.
8. Replace cam stack, as instructed on page 158.
9. Replace needle thread take-up and needle bar vibrating bracket, as instructed on page 157.
10. Adjust machine as instructed on page 137.
11. Replace arm top cover and face plate.

HINTS FOR ADJUSTERS AND MECHANICS

CHECK THESE POINTS WHEN A MACHINE BINDS

1. Sprung or cracked bed or arm incurred during transit.
 2. Bent arm shaft.
 3. Arm shaft thrust collar (at front of arm) set too tight.
 4. Bent needle bar.
 5. Tightness in needle bar vibrating bracket assembly or in bottom ball bushing assembly.
 6. Needle bar vibrating bracket hinge pin not correctly seated.
 7. Burr in needle bar driving arm ball pivot hole in bight amplitude pattern selector.
 8. Bent take-up lever.
 9. Thread take-up stud set too tightly.
 10. Misalignment of thread take-up lever link hinge stud.
 11. Insufficient thread clearance.
 12. Hook jammed with thread.
 13. Hook driving shaft collar set too close.
 14. Tightness of hook driving shaft.
 15. Insufficient clearance between hook driving shaft bushing (back) and gear.
 16. Hook shaft bushing is "floating", even though fastening screw may be tight.
 17. Gear meshes too tight. (See CAUTION at top of page 154.)
 18. Feed dog striking ends of throat plate slot or rubbing side of throat plate.
 19. Feed bar screw centers too tight.
 20. Feed lifting connecting rod bent.
 21. Feed lifting and feed rock shaft screw centers too tight.
 22. Feed fork bent.
 23. Insufficient clearance between arm and hand wheel bushing for heat expansion.
 24. Worm wheel on cam stack set too close to worm on arm shaft.
 25. Height of follower index pins not correctly set.
 26. Burrs or damage to bearing surfaces.
 27. Insufficient clearance between hand wheel and its recess in arm casting.
- NOTE:** See page 24 for hints on other causes of machine troubles, such as needle breakage and machine noise.

TO "RUN-IN" THE MACHINE

When a machine is completely assembled and adjusted, it should be checked for binding first. Lubricate the machine, as instructed on pages 126 and 127. Then "run-in" the machine with an electric motor, for from 5 to 10 minutes at medium speed or until all moving parts run smoothly when machine is turned

over by hand.

"Running-in" a machine should be done after every installation of an arm shaft, a hook driving shaft or a cam selector mechanism, and after every general repair.

WIRING DIAGRAM FOR MACHINES OF CLASS 401

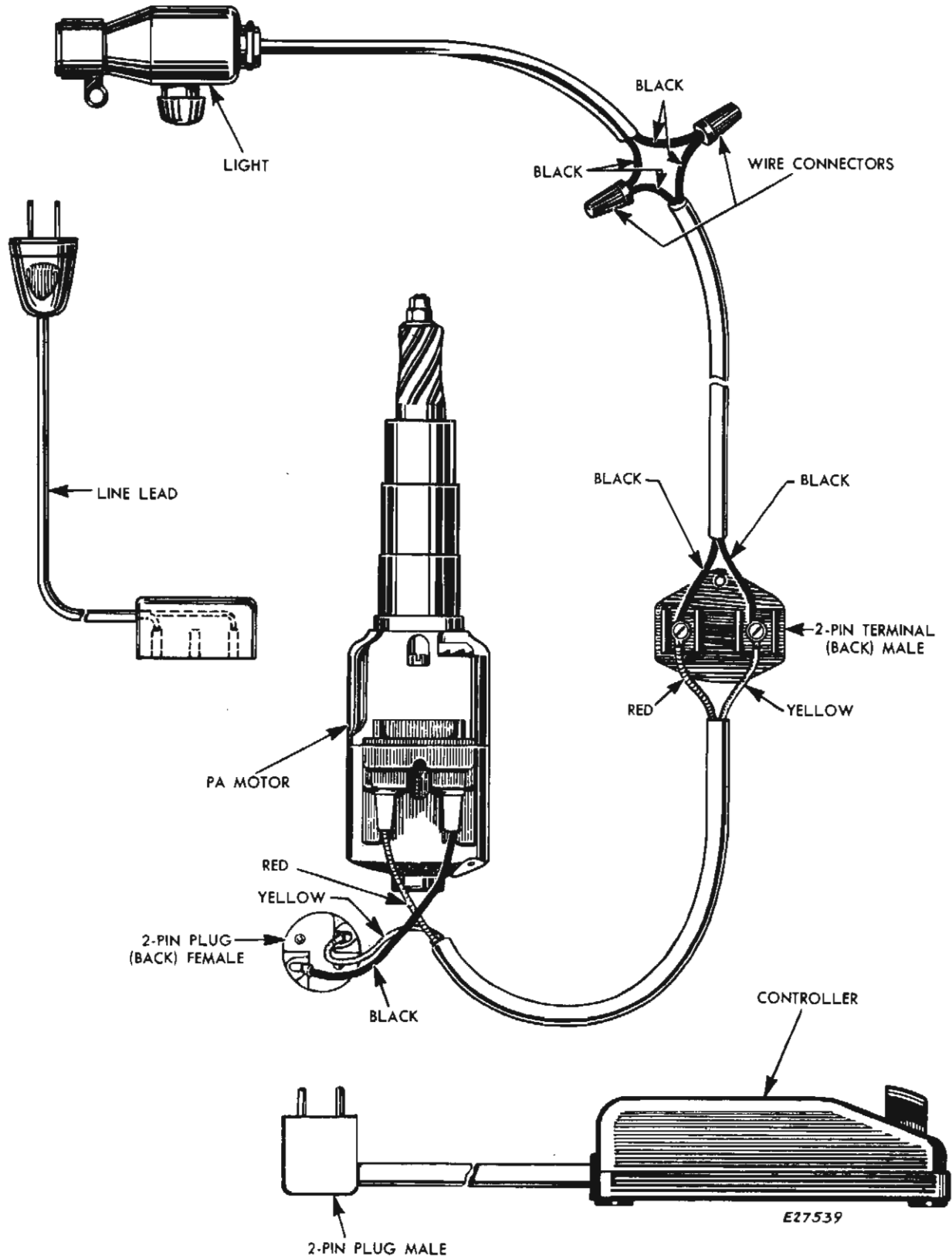

DESCRIPTION

Machine 401A (Automatic)

For straight, zigzag and ornamental stitching

Lockstitch

Electric power, **gear driven, with PA Motor enclosed in machine**

SINGER Light, with built-in switch, provides perfect illumination

Light shade and lens assembled to arm as **separate unit**

Needle (15 x 1) threaded from front to rear

Single or two-needle stitching

Needle bar and presser bar **inclined at 9°** from vertical for easy vision

Hinged face plate facilitates oiling and adjusting of needle bar, presser bar and thread take-up. **Diagram on inside of face plate illustrates threading** of machine

Hinged presser foot

Two throat plates, one for zigzag and one for central straight stitching, are furnished with machine

Throat plate position lever, on bed, locks throat plate in "down" or sewing position, raises throat plate sufficiently to permit darning or embroidery and raises throat plate still higher to unlock it for easy removal

Reversible clamp washer for stop motion mechanism

Automatic bobbin winder. Extra capacity bobbin. Bobbin winder tension and nylon spool pin on bed

Gear driven, rotary hook on **vertical axis**, located in front of needle, makes two revolutions to each stitch

Maximum width of zigzag stitch (bight) — approximately 3/16 inch (5mm.)

Straight stitching as well as zigzag stitching performed at Central Position of needle, at extreme Left Position, at extreme Right Position or at any point between these positions

Needle can swing a maximum of 3/16 inch toward right of extreme Left Position or toward left of extreme Right Position or a maximum of 3/32 inch on either side of Central Position

Straight, Zigzag or Ornamental stitching is accomplished by setting one or two knobs and a lever for selection of a particular stitch. Machine is fitted with seven built-in cams and one removable "Special" cam. Special cams with different stitch designs can be purchased and used in place of the removable cam furnished with the machine

Two cam selector knobs and a red (bight amplitude) lever are located on front of arm in direct view of operator. Red lever also controls position of needle during straight stitching. The outer knob controls a rear cam follower. The inner knob controls a front cam follower. Selection of the positions of these two knobs and the red lever makes possible particular designs and combinations of designs automatically

Stitch pattern plate cover on top of arm holds two nylon spool pins on top side and a chart on under side illustrating many particular designs determined by given knob and lever settings

Reversible feed

Graduated stitch length indicator plate. Feed regulator adjustable for **finer** regulation of short stitch

Maximum stitch length—6 to inch

Link take-up

Numerically graduated tension device provided with central spacing disc for two needle threads

Needle bar stroke 1-9/64 inches

Presser bar lift **.295** inch

Aluminum arm and bed

Bed 16-1/2 inches long—7 inches wide

Working space at right of needles 7-3/16 inches

Speed 1200 to 1300 R.P.M.; according to material being sewn and type of work being done

When in operation, top of hand wheel should **always turn over toward operator**

INDEX

| | Page | | Page |
|--|----------------|--|-------------|
| Description of Machines | 163-168 | Installation, 206K25 | 101, 102 |
| Instructions for 306 automatic | 3 | Installation, 319 | 112 |
| Instructions for 306 and 206K43 non-automatic .. | 81 | Installation, 401 | 157-159 |
| Instructions for 206K25 | 87 | Reason for disassembly, 306 and 206K43 | 69 |
| Instructions for 319 | 103 | Reason for removal, 306 and 206K43 | 67 |
| Instructions for 401 | 125 | Reason for removal, 206K25 | 92, 95 |
| Arm shaft connection belt | | Reassembly, 306 and 206K43 | 70-72 |
| Care | 28 | Reassembly, 206K25 | 100-102 |
| Removal from automatic | | Removal, automatic and non-automatic | 67 |
| 306 | 25 | Removal, 206K25 | 99 |
| 319 | 106 | Summary of controls and varieties of | |
| Removal from non-automatic | 89 | stitching, 306 and 206K43 | 64-67 |
| Replacement on automatic | | Summary of controls and varieties of | |
| 306 | 26-28 | stitching, 206K25 | 97-99 |
| 319 | 107 | Bight lever sub-assembly, automatic | 71 |
| Replacement on non-automatic | 90 | Bight limit screws, 306 and 206K43 | 63 |
| Timing Feed | 29 | Bight mechanism, exploded view on automatic | 68 |
| Arm shaft, removal and replacement | 160 | Bight mechanism, exploded view on | |
| Bearing sleeve sub-assembly | 70 | non-automatic | 85 |
| Bench inspection, order of | | Bight mechanism, exploded view on 206K25 | 100 |
| checking customer's machines | 5 | Bight stops, 401 | 140 |
| Bight amplitude stops, setting | 140 | Binding in feed connection assembly | 109, 136 |
| Bight amplitude and pattern | | Binding of feed rock shaft connecting link | 32, 136 |
| selector - removal and replacement | 159 | Binding or end play in hook shafts | 38, 40, 136 |
| Bight | | Binding or looseness in needle vibrating | |
| Stitching at various widths, 306 and 206K43 | 62 | mechanism | 48, 135 |
| Stitching at various widths, 206K25 | 96 | Bobbin cases (differences) | 105 |
| Bight control, installation on automatic | 73 | Bobbin case holder, oiling | 76, 123 |
| Bight control, installation on 206K25 | 101-102 | Bobbin case holders (differences) | 105 |
| Bight control lever | 62-67 | Bobbin thread tension, adjustment | 21 |
| Bight control lever, 206K25 | 92-99 | Bobbin winder adjustment | 79 |
| Bight control mechanism | | Bobbin winder, removal and replacement (401) .. | 151 |
| Adjustment, automatic | 58-61, 138-141 | Breaking needles, prevention of | 11, 24 |
| Adjustment, non-automatic (except 206K25) | 84 | Cam selector arm shaft and followers, | |
| Adjustment, 206K25 | 91-95 | removal and replacement | 158 |
| Disassembly of 306 and 206K43 | 68, 69 and 85 | Cam selector arm stops | 139 |
| Disassembly, 206K25 | 99, 100 | | |
| Installation, 306 and 206K43 | 73 | | |

INDEX (Continued)

| | Page | | Page |
|---|-----------|--|--------------|
| Cam stack, timing | 138, 139 | End play or binding in feed lifting rock shaft | 136 |
| Cam stack, removal and replacement | 158 | End play or binding in feed rock shaft | 136 |
| Central needle position (straight stitch) 306 and 206K43 | 64 | End play or binding in hook driving shaft | 38, 136 |
| Central needle position (straight stitch) 206K25 .. | 97 | End play or binding in hook shaft | 40 |
| Central needle position (zigzag stitch) 306 and 206K43 | 66 | Side-shake or binding in needle bar | 135 |
| 401 (#3 Position) | 141 | End play or binding in stitch regulator | 135 |
| Central needle position (zigzag stitch) 206K25 | 98 | End play or binding in upright arm shaft | 137 |
| Centralizing needle in needle hole of throat plate (401) | 142 | Fabric, needle and thread chart | 10 |
| Checking customer's machines at the bench | 5 | FASHION disc follower frame and needle bar pitman removal and replacement | 50, 51 |
| Check list for serviceman in the home, sample | 7 | FASHION disc follower frame stud adjustment, automatic | 49 |
| Check spring, setting | 132, 133 | FASHION disc follower frame (319) Adjustment | 115 |
| Clamp stop motion, adjustment | 78 | Noisy | 119 |
| Clamp stop motion, removal and replacement | 78 | FASHION Discs (319) Removal | 116 |
| Non-reversible clamp washer, 206 | 90 | To assemble stack | 117 |
| Reversible clamp washer, 306 | 27, 28 | To replace stack | 117 |
| Reversible clamp washer, 401 | 150 | To substitute | 116 |
| Coordinating extreme left and right needle positions, 306 and 206K43 | 61 | FASHION Disc Selectors (319) Removal | 113 |
| Coordination of bight control settings, 306 and 206K43 | 58-61 | Replacement | 114 |
| Coordination of bight control settings, 206K25 | 91-95 | Feed and presser foot tests for squareness | 57 |
| Counterbalance (401) | 150 | Feed connection assembly (binding) 319 | 109 |
| Description of machines | 163-168 | Feed dog adjustment in relation to throat plate slots (sidewise and lengthwise) | 32, 129, 130 |
| Description of needles | 11 | Feed dog clearance above hook | 31 |
| Eccentric location on hook driving shaft | 30 and 39 | Feed dog height adjustment 206, 306 | 30 |
| End play or binding in arm cross shaft, automatic | 49 | 319 | 108 |
| End play or binding in arm shaft | 49, 137 | 401 | 129 |
| End play or binding in feed bar | 130 | Feed forked connection assembly, removal | 36, 155 |
| | | Feed forked connection, installation | 37, 155 |
| | | Feed lifting rock shaft removal and replacement | 153 |

INDEX (Continued)

| | Page | | Page |
|--|-------------------------|--|----------|
| Feed regulator assembly, removal | 34 | Inspection at the bench | 5 |
| Feed regulator assembly, replacement | 35, 151 | Preparation of machine | 126 |
| Feed rock shaft connecting link | | Inspection in the home, order of | 6 |
| Adjustment for zero stitch length | 33 | Installation of feed forked | |
| Adjustment to avoid binding | 32 | connection assembly | 37, 155 |
| Feed rock shaft, removal and replacement | 153 | Instructions on 206K25 | 87 |
| Feed throw-out | 58 | Instructions on 306 automatic | 3 |
| Feed timing | 29, 131 | Instructions on 206K43 and 306 | 81 |
| Fork connection, centralizing eccentric stud, | | Instructions on 319 | 103 |
| non-automatic (except 206K25) | 84 | Instructions on 401 | 125 |
| Formation of lock stitch | 13-15 | Left needle position (straight stitch), 206K25 | 97 |
| Gear location on hook driving shaft | 30 and 39 | Left needle position (straight stitch), | |
| Hand wheel, removal | 25, 89, 150 | 206K43 and 306 | 64 |
| Hand wheel, replacement | 27, 90, 150 | Left needle position (zigzag stitch), 206K25 | 97 |
| Height of index pins | 138 | Left needle position (zigzag stitch), | |
| Height of needle bar setting with gauge | 45 | 206K43 and 306 | 65 |
| Height of needle bar setting without gauge | 44, 133 | Left, right and central needle positions, | |
| Height of presser bar | 56, 128 | coordination of | |
| Hints for adjusters and mechanics | 23, 161 | 206K25 | 91-95 |
| Hook and needle | | 306 and 206K43 | 59-61 |
| relationship | 9, 41, 43, 44, 143, 144 | 401 | 140 |
| Hook driving shaft, removal and replacement | | Length of stitch | 33 |
| 206, 306 | 39 | Light fixture (401), remove and replace | 146 |
| 319 | 110 | Limit screws (bight), 206K43 and 306 | 63 |
| 401 | 153 | Location of needle in needle clamp | |
| Hook driving shaft, removal of end play | | Automatic and non-automatic | 12 |
| or binding | 38 | 206K25 | 88 |
| Hook, setting of | 41, 143, 144 | Lock stitch formation | 13-15 |
| Hook shaft, removal of end play or binding | 38 | Lubrication | |
| Hook driving shaft, removal of end play | | 206, 306 | 74-77 |
| or binding (401) | 136 | 319 | 121-123 |
| Hook timing | 43, 143 | 401 | 126, 127 |
| Sequence of adjustments to be verified before | | Machine, "run-in" | 79, 161 |
| timing hook | 43 | Maximum bight, 206K25 | 96 |
| Index pins, setting height | 138 | Maximum bight, 206K43 and 306 | 63 |
| Indicator plate of bight control | 70 | Maximum zigzag stitch, 206K25 | 98 |

INDEX (Continued)

| | Page | | Page |
|---|-------------|---|--------------|
| Maximum zigzag stitch, 206K43 and 306 | 65 | Needle breaking, prevention of | 11, 24 |
| Motor, CAUTION against lubrication | 77 | Needle description | 11 |
| Motor, cleaning bracket boss, 319 | 118 | Needle, fabric and thread chart | 10 |
| Motor, remove and replace (401) | 145 | Needle location in clamp | 12, 88 |
| Needle adjustment, sidewise in relation to throat plate and presser foot | 52, 142 | Needle, ordering | 11 |
| Needle and hook point setting | 41, 144 | Needle pendulum setting, adjustment | 52 |
| Needle and hook timing | 43, 143 | Needle perforation tests, 206K25 | 91-95 |
| Needle bar connecting link noisy, 319 | 120 | Needle perforation tests, 306 and 206K43 | 58-59 |
| Needle bar damage | 41, 48 | Needle position, correction in relation to straight-stitching throat plate | 22, 134 |
| Needle bar driving arm, centralizing | 141 | Needle position, sidewise adjustment | 52, 142 |
| Needle bar driving arm, removal and replacement | 159 | Needle and hook, relationship | 9 |
| Needle bar height indicator, adjustment 206, 306 | 42 | Needles and threads | 8 |
| 319 | 111 | Needle sizes | 10 |
| Needle bar height, setting with gauge | 45 | Needle striking sewing hook or presser foot | 24 |
| Needle bar height, setting without gauge | 44, 133 | Needle swing | 62, 96 |
| Needle bar holder, removal | 46 | Needle thread take-up and feed timing | 29 |
| Needle bar holder, replacement | 47 | Needle thread take-up (Check) spring, setting | 132 |
| Needle bar pitman and FASHION disc follower frame, removal and replacement .. | 50, 51 | Needle thread take-up, removal and replacement | 157 |
| Needle bar, radial alignment | 44, 45, 133 | Needle thread tension | 18-20 |
| Needle bar, removal and replacement | 46, 47, 156 | Needle thread tension, regulation | 18, 132, 133 |
| Needle bar setting with gauge | 45 | Needle thread tension, removal and disassembly | 18, 148, 149 |
| Needle bar setting without gauge | 44, 133 | Needle vibrator fork connection (removal and replacement) non-automatic | 82 |
| Needle bar, timing pendulum movement with gauge (automatic) | 55 | Needle vibrating mechanism, check for looseness or binding | 48, 135 |
| Needle bar, timing pendulum movement without gauge (automatic) | 53, 54 | Needle vibration, eliminating with gauge on automatic | 60 |
| Needle bar, timing pendulum movement without gauge (non-automatic) | 83 | Needle vibration, eliminating with gauge on non-automatic | 84 |
| Needle bar vibrating bracket removal and replacement | 156, 157 | Oiling bobbin case holder | 76 |

INDEX (Continued)

| | Page | | Page |
|--|----------|--|---------|
| Oiling machine | | Removal of feed regulator assembly | 34, 151 |
| 206, 306 | 74-77 | Replacement of cam stack, 401 | 158 |
| 319 | 121-123 | Replacement of discs, 319 | 117 |
| 401 | 126, 127 | Replacement of feed regulator assembly | 35, 151 |
| Order of inspection of customer's machines | | Right needle position (straight stitch), | |
| at the bench | 5 | 306 and 206K43 | 64 |
| Order of inspection in the home | 6 | Right needle position (zigzag stitch), | |
| Ordering needles for swing-needle machines | 11 | 306 and 206K43 | 65 |
| Over-lubrication, dangers of | | "Run-in" machine | 77, 161 |
| 206, 306 | 76 | Sample check list for serviceman in the home | 7 |
| 319 | 123 | Setting hook | 41, 144 |
| Pendulum setting of needle | 52 | Setting needle, 206K25 | 88 |
| Pendulum timing of needle bar | | Setting needle 306 and 206K43 | 12 |
| with gauge on automatic | 55 | Setting needle bar height with gauge | 45 |
| Pendulum timing of needle bar | | Setting needle bar height without gauge | 44, 133 |
| without gauge on automatic | 53, 54 | Setting up machine | 4 |
| Pendulum timing of needle bar | | Sewing difficulties, causes and remedies | 17 |
| without gauge on non-automatic | 83 | Side-shake or binding in needle bar | 135 |
| Perfect lock stitch | 15 | Stitch formation | 13-15 |
| Pitman and frame (removal and | | Stitch indicator plate | 33 |
| replacement) | 50, 51 | Stitching at various widths of bight and | |
| Pitman fulcrum eccentric stud, centralizing | 60 | positions of the needle | 62, 96 |
| Position finger, adjustment for thread clearance | 42 | Stitch length, regulating | 33 |
| Position lever settings, 206K25 | 97-99 | Stitch regulator handle, removal | 34 |
| Position lever settings, 306 and 206K43 | 64-67 | Stitch regulator handle, replacement | 35 |
| Presser bar height | 56 | Stop motion, adjustment | 78 |
| Preparation of machine for inspection | 126 | Stop motion, removal and replacement | 78 |
| Presser bar, removal and replacement | 156 | Non-reversible clamp washer, 206 | 90 |
| Presser foot alignment to feed | 57, 128 | Reversible clamp washer, | |
| Presser foot and needle relation | 52 | 306 | 27, 78 |
| Presser foot height | 128 | 401 | 150 |
| Presser foot, regulating pressure of | 56 | Suggestions to the serviceman in the home | 6 |
| Removal of discs 319 | 116 | Summary of bight controls on automatic | 62-63 |

INDEX (Continued)

| | Page | | Page |
|---|--------------|---|--------------|
| Summary of bight controls on 206K25 | 96 | Timing pendulum movement of needle bar without gauge, automatic | 53, 54 |
| Take-up in relation to feed timing | 29 | Timing pendulum movement of needle bar without gauge, non-automatic | 83 |
| Tension conditions | 16 | Tips on setting up machine | 4 |
| Tension on bobbin thread | 21 | Twin needle alignment | 44, 45 |
| Tension on needle thread | 18, 132, 133 | Twin needles, description of | 11 |
| Tests for squareness of presser foot to feed | 57 | Twist of thread | 10 |
| Thread clearance between position finger and bobbin case base | | Upright arm shaft | 145 |
| 206, 306 | 42 | Varieties of stitching and summary of bight controls, 206K25 | 97-99 |
| 319 | 111 | Varieties of stitching and summary of bight controls, 306 and 206K43 | 64-67 |
| Thread clearance, Machine 401 | 131 | Winding bobbins evenly | 79 |
| Thread, needle and fabric chart | 10 | Wiring diagram (401) | 162 |
| Threads and needles | 8 | Wiring harness, 319W3 | 118 |
| Thread take-up (Check) spring, stroke of | 19, 132 | Wiring harness 401, remove and replace | 147 |
| Thread take-up (Check) spring, tension of | 20, 132 | Zero bight, 206K25 | 92-94, 96-98 |
| Thread twist | 10 | Zero bight, 306 and 206K43 | 62 |
| Throat plate position bracket | 152 | Zeroing out machine | 140 |
| Timing cam stack | 138, 139 | Zigzag stitching, 206K25 | 92-94, 96-98 |
| Timing feed | 29, 131 | Zigzag stitching, 306 and 206K43 | 65-67 |
| Timing hook in relation to needle | 43, 143 | | |
| Timing pendulum movement of needle bar with gauge, automatic | 55 | | |