

ATHENA* 2000 Electronic Sewing Machine ... at a glance

ELECTRONIC STITCH SELECTION

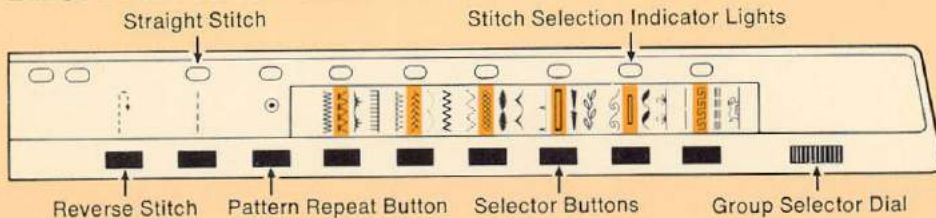

When you move the group selector dial, one of four different groups of patterns is available to you. From this group, you further choose the particular pattern you wish to sew with. Turn your sewing machine on. You will note a slight movement of the needle. After moving the group selector dial, press the button under the desired pattern. A red light will appear above the pattern. Your machine is now ready to sew. Stitch width and stitch length are automatically programmed. Follow the same procedure to automatically switch to another pattern.

Note: We recommend use of the SLOW speed setting when you have selected Buttonholes, *Flexi-Stitch** patterns, the Basting Stitch or Maxi-stretch Stitch.

Straight stitching

To do straight stitching, simply press the button under the  symbol on the stitch panel. A red light will appear above the symbol, and your machine is programmed to produce a basic straight stitch, suitable for most straight-stitch requirements.

Straight-stitch plate and foot

Best for all straight stitching. Be sure to use these accessories when your fabric requires close control. They are especially helpful for stitching delicate fabrics.



Plate



Foot

When you use the straight-stitch plate or presser foot, be sure to set your machine for straight stitching to prevent possible needle breakage. However, when you use the *straight-stitch plate*, you get this exclusive feature: If you press another button by mistake, your machine will still sew a straight stitch. Mistake-proof straight-stitch selection.

Pattern repeat button

The special pattern repeat button on your machine lets you sew one unit of a pattern — such as one tulip, one dog, and so on. Simply select desired pattern, then *also* press the pattern repeat button ( symbol). The red light will appear above the symbol. Press down on controller. Your machine will stitch one unit of the pattern each time you do this.

Starting to sew

Position needle in fabric and lower foot. Start machine by pressing lightly on the speed controller.

Sewing in reverse

If you wish to reinforce the beginning or end of a seam, touch and hold the reverse button. Your machine will sew a *straight-stitch* in reverse for as long as you hold the button, regardless of the stitch pattern you have been sewing.

Removing work from machine

Raise needle and foot. Draw fabric back to the left. Cut threads on thread cutter at rear of presser bar, leaving four inches of thread.

Note: Be sure to raise needle out of fabric when machine is turned off.

INDIVIDUAL PREFERENCES

Your sewing machine will produce all of your stitching requirements at a programmed stitch width and a programmed stitch length. However, if you wish to accommodate different fabric characteristics or satisfy a personal preference, you can change the settings by opening the cover of the individual preference panel, then manually adjusting the controls located on the panel.

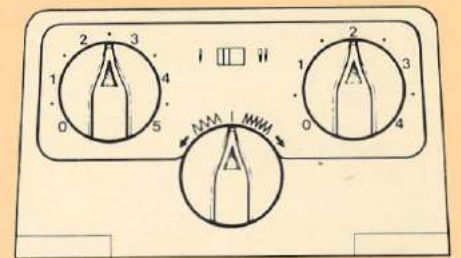

Stitch width

- Lightly touch the stitch width pointer to activate the stitch width control, indicated by a red light on the stitch panel.
- Turn pointer until desired width is achieved. Your machine will now stitch at preferred width.

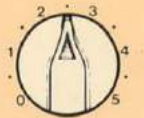

Stitch Width Control

Stitch length

- Lightly touch the stitch length pointer to activate the stitch length control, indicated by a red light on the stitch panel.
- Turn pointer until desired length is achieved. Your machine will now stitch at the preferred length.

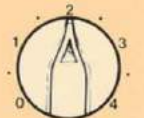

Stitch Length Control

Both controls may be used simultaneously. To cancel, press any button except those for reverse or pattern repeat sewing.

Instructions for Threading the Machine

SINGLE-NEEDLE STITCHING

Threading the needle

Place spool of thread on horizontal spool pin. If spool being used has a retaining slit, this should be placed against the spool cushion to the right. Select correct spool holder according to type and diameter of spool being used. The diameter of the end of the spool holder should always be larger than that of the spool itself. Press spool holder firmly against spool.

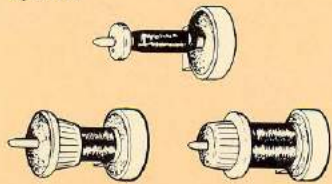

Raise take-up lever to its highest position by turning the hand wheel toward you. Raise presser foot to release tension discs. Lead thread from spool holder and snap it down into guidepost eyelet. Lead thread under rear thread guide, through the pretension and across the slot in the top of the machine.

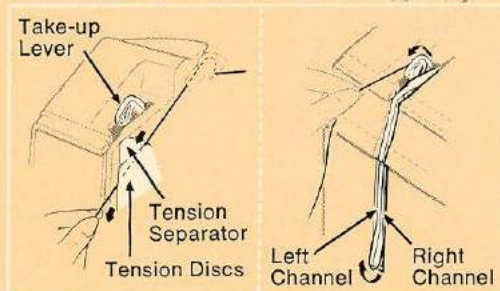
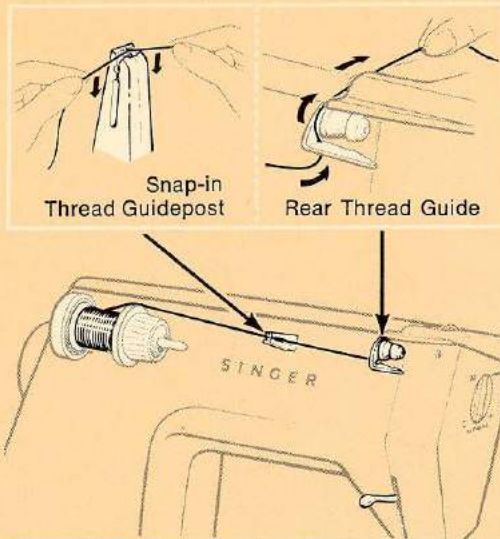

Draw thread *firmly* into tension disc on right of tension separator. Draw thread down right channel and up left channel. Thread take-up lever by guiding thread through slot and into eyelet. Lead thread from take-up lever down through left channel again, follow it diagonally to the end, then into lower thread guides. Thread needle from front to back, drawing about four inches of thread through eye of needle.

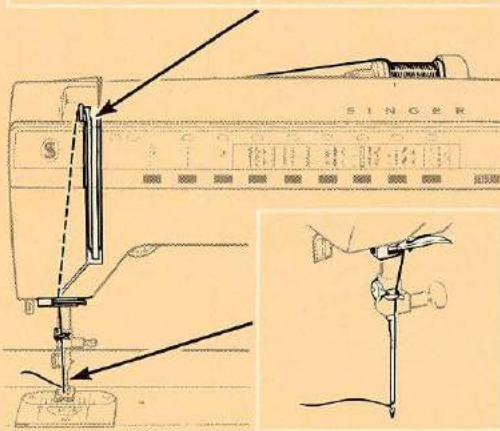

WINDING THE BOBBIN

1. Open slide plate. Move bobbin latch to left. Slip empty bobbin with the slot on top into case. Leave slide plate open until bobbin is wound. Turn on power switch. Press straight-stitch button.

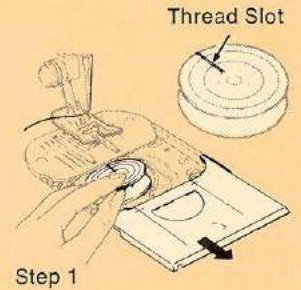

2. Move bobbin latch to right into wind position.



3. Draw needle thread back under left side of presser foot, then up and around and into thread retainer. Do not hold thread end. Start machine running at moderate speed.

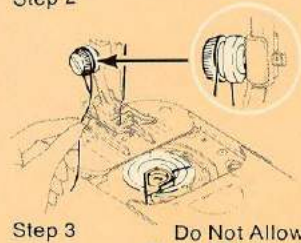

4. Pull thread end away after it has separated from bobbin. Do not allow thread to wind beyond outside FULL ring.



5. Close slide plate. Before starting to sew, pull thread back under presser foot and cut, leaving about 4 inches.

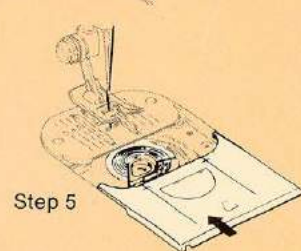

SINGER

Athena 2000

ELECTRONIC

operator's guide

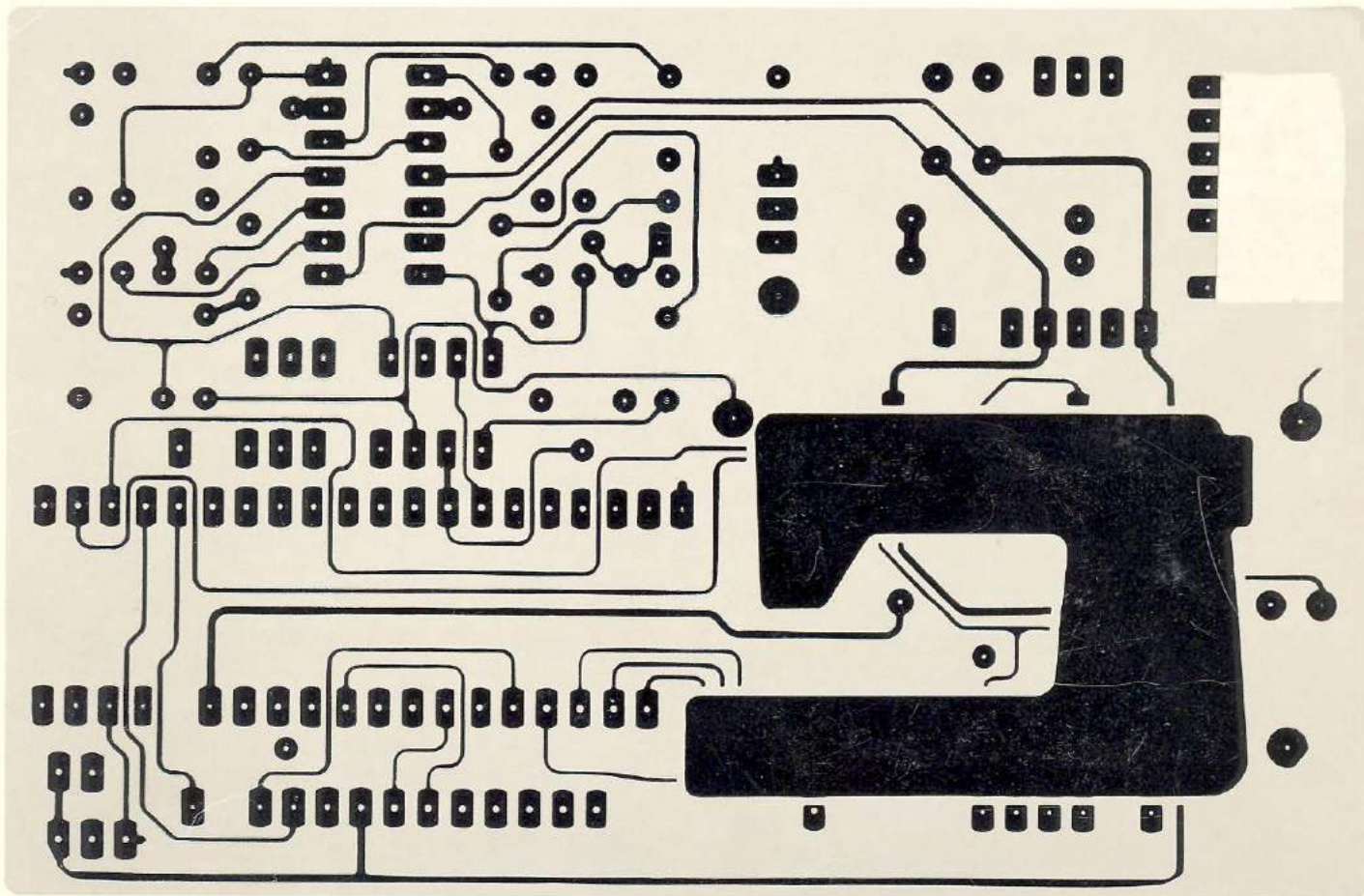

Athena 2000

Solid-state Electronic Sewing Machine

Congratulations...

You are about to sew on the most advanced sewing machine in the world... *ATHENA 2000*.

It makes sewing so simple, so foolproof — and so much fun! — you will be astounded.

The crowning achievement of years of Singer research, *ATHENA* 2000* sewing machine features these important technological breakthroughs:

- **Exclusive Solid-state Electronic Sewing System.** *ATHENA 2000* is the sewing machine with the electronic "brain." A storehouse of sewing knowledge, it automatically programs your machine to sew one of *twenty-five* different stitches—including two types of buttonholes.
- **Exclusive Light Touch Fingertip Controls.** They're the buttons on the front of the machine. You simply touch the one under the pattern you want — the red indicator light comes on — and *ATHENA 2000* is ready to sew. Any stitch is instantly available, at the touch of a single button.
- **Exclusive Individual Preference Panel.** Your very own "control panel," it allows you to modify the programmed stitch dimensions to your heart's content, to suit special fabrics and satisfy personal preferences.

And that is only the beginning! There are so many *more* new features. Such as the Exclusive Pattern Repeat Button—that lets you sew one *unit* of a pattern, for superb decorative touches. And Exclusive Light Touch Fingertip Quick Reverse Button—for an instant reverse straight stitch. And over a dozen more Singer Exclusives. *Plus*, all of the other Singer advances of the past decade. Such as the fabulous Exclusive built-in *Flip & Sew** panel for both flat and in-the-round sewing. Soft-touch Fabric Feed, that protects even the most delicate fabrics. Variable-speed, Solid-state Control System, that enables you to maintain the same pressure on the speed controller as you sew through varying fabric thicknesses. And many, many more advances, from Singer.

We suggest you take a few moments to read through this new operator's guide, as you sit at your machine. You will quickly discover how simple it is to do any sewing operation you desire on *ATHENA 2000*.

Welcome . . . to the future world of sewing!

Today!

CONTENTS

Getting to Know Your ATHENA 2000 Electronic Sewing Machine	2
Accessories	3
Changing Presser Feet	4
Snap-on Presser Feet • The Button Foot • Even Feed Foot	
Changing Plates	5
Chainstitch Plate and Insert	5
Speed Control	6
Needles	6
Changing the Needle	
Threading the Machine	7
Threading the Needle	
The Bobbin	8
Winding the Bobbin • Removing the Bobbin • Replacing a Wound Bobbin • Raising the Bobbin Thread • Removing Thread from Bobbin	
Threading for Twin-Needle Stitching	10
Regulating Pressure	11
Adjusting Thread Tension	11
Lifting the Presser Foot	11
Electronic Sewing	12
Selecting a Stitch • Straight-Stitching • Straight-Stitch Plate and Foot • Pattern Repeat Button • Starting to Sew • Sewing in Reverse • Removing Work from Machine • Chainstitching	
Individual Preferences	14
Stitch Width • Stitch Length • Reverse Stitch-balance	
One-step Buttonholing	15
Balancing the Density • Stitching a Series of Buttonholes	
Two-step Buttonholing	16
Corded Buttonholes	17
Inserting Cord in One-step Buttonhole Foot • Inserting Cord in Two-step Buttonhole Foot	
Free-Arm Sewing	18
Circuit Breaker	18
Cleaning the Machine	19
Changing the Light Bulb	19
Performance Checklist	20

Getting to Know Your ATHENA 2000 Electronic Sewing Machine

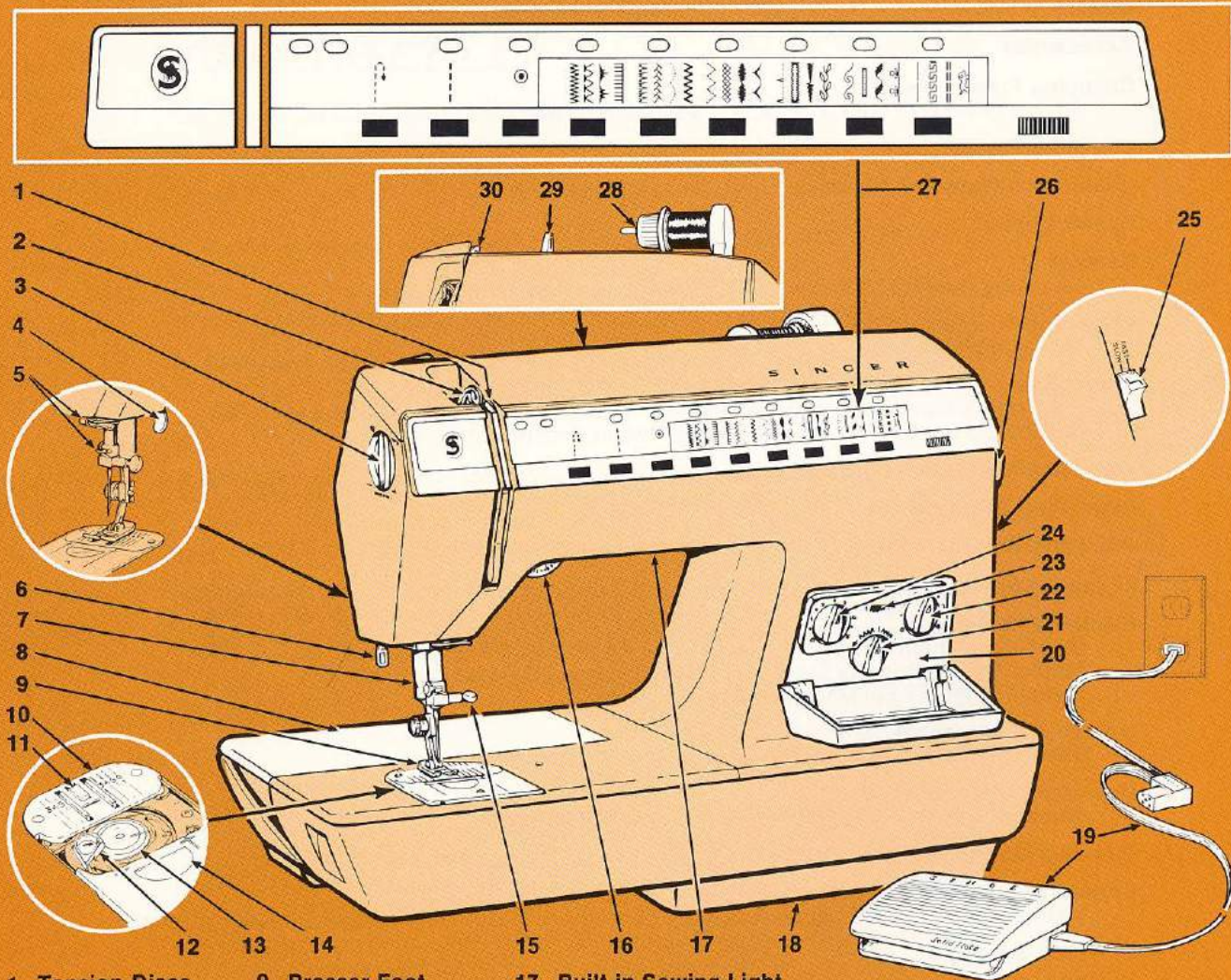

- | | | | |
|------------------------|------------------------|---|--------------------------------|
| 1. Tension Discs | 9. Presser Foot | 17. Built-in Sewing Light | 24. Stitch-width Control |
| 2. Take-up Lever | 10. Zig-Zag Plate | 18. Circuit Breaker | 25. Power and Light Switch |
| 3. Pressure Dial | 11. Soft-touch Feed | 19. Electrical Connections and Speed Controller | 26. Hand Wheel |
| 4. Presser-foot Lifter | 12. Bobbin Latch | 20. Individual Preference Panel | 27. Stitch Selection Panel |
| 5. Thread Guides | 13. Transparent Bobbin | 21. Reverse Stitch-balance Control | 28. Friction-free Spool Holder |
| 6. Buttonhole Lever | 14. Slide Plate | 22. Stitch-length Control | 29. Snap-in Thread Guidepost |
| 7. Thread Cutter | 15. Needle Clamp | 23. Twin-needle Switch | 30. Rear Thread Guide |
| 8. Hinged Plate | 16. Tension Dial | | |

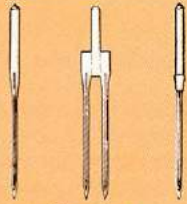

Needles



Transparent Bobbins

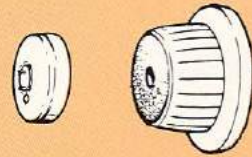

Small and Large Spool Holder



Secondary Spool Pin

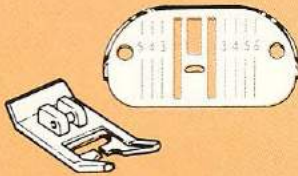

Zig-Zag Foot and Plate

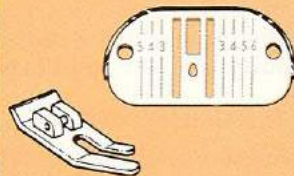

Straight-stitch Foot and Plate

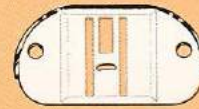

Cover Plate

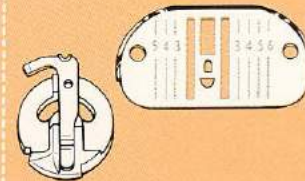

Chainstitch Fittings

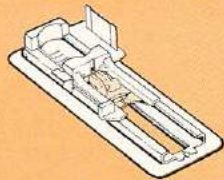

One-step Buttonhole Foot

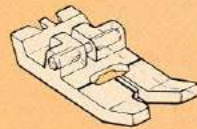

Two-step Buttonhole Foot



Button Foot

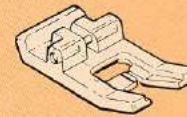

Special-purpose Foot

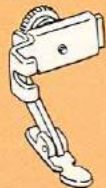

Zipper Foot



Overedge Foot

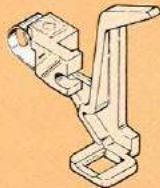

Darning and Embroidery Foot

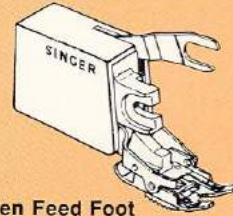

Even Feed Foot



Buttonhole Gauge



Seam Guide

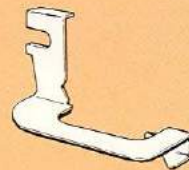

Blindstitch Hem Guide

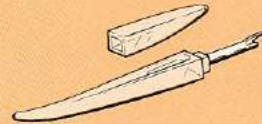

Seam Ripper



Lint Brush

Changing Snap-on Presser Feet

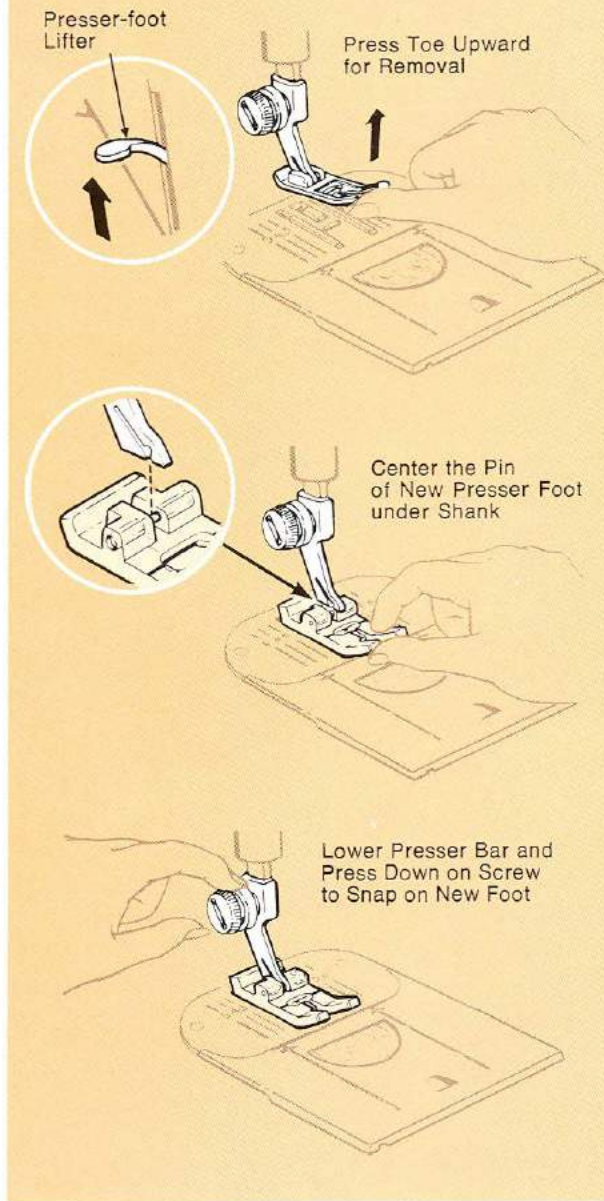

CHANGING PRESSER FEET

Snap-on Presser Feet

Raise take-up lever to highest position by turning hand wheel toward you. Raise presser foot by raising presser foot lifter, located at back of machine. Press front of foot up as far as it will go, then snap down to remove. Center new foot under shank. Lower presser-foot lifter so shank fits over pin. Press presser-foot screw down until foot snaps in place.

The Button Foot

Raise take-up lever to highest position by turning hand wheel toward you. Raise foot. Loosen presser-foot screw and remove presser-foot shank. Hook button foot around the presser bar and tighten presser-foot screw.

Even Feed Foot

Raise take-up lever to highest position by turning hand wheel toward you. Raise foot. Loosen presser foot screw and remove presser foot shank. Guide Even Feed Foot into position from back of machine. Make sure movable arm straddles needle clamp. Tighten presser-foot screw with coin.

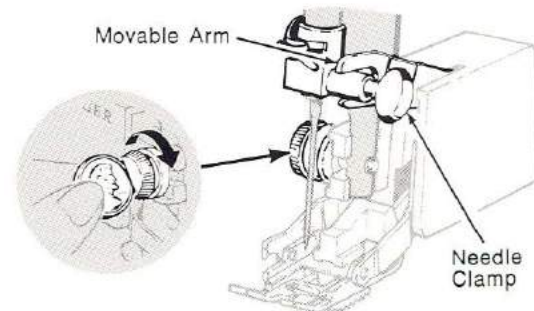

Attaching Even Feed Foot

Darning and Embroidery Foot

Raise *needle* to highest position by turning hand wheel toward you. Raise foot. Loosen presser foot screw and remove presser foot shank. Guide Darning and Embroidery Foot into position from back of machine. Make sure lifting finger is above needle clamp. Tighten presser foot screw with coin.

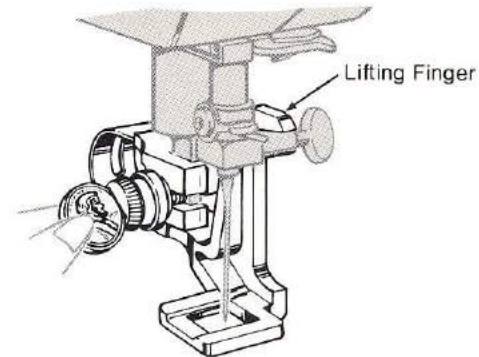

Attaching Darning and Embroidery Foot

CHANGING PLATES

Note: Remove bobbin if it contains thread in order to prevent thread being caught when plate is replaced.

Raise take-up lever to its highest position and raise presser foot. Open slide plate. Move bobbin latch to left and remove bobbin and plate you have been sewing with. As shown in top diagram at right, press down on front edge of plate you have been sewing with, and lift up and out.

Position new plate over pins. Plate is drawn into position by magnets. Replace bobbin. Close slide plate.

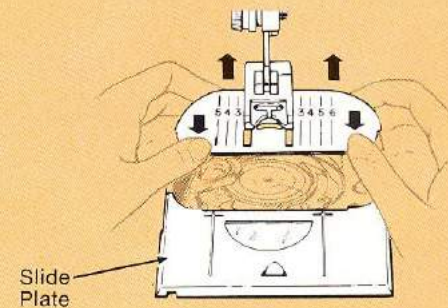

Removing Plate

CHAINSTITCH PLATE AND INSERT

Raise take-up lever to its highest position and raise presser foot. Open slide plate. Move bobbin latch to left and remove bobbin and plate you have been sewing with. Place bobbin-case insert in bobbin case as shown, with finger of insert positioned under the feed. Position chainstitch plate over holding pins, making certain that the post of the bobbin-case insert finger enters the hole in the plate. Close slide plate.

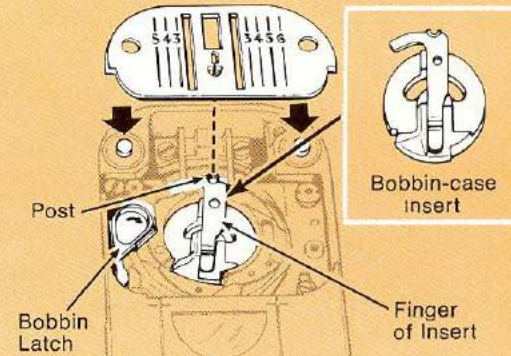

Attaching Chainstitch Fittings

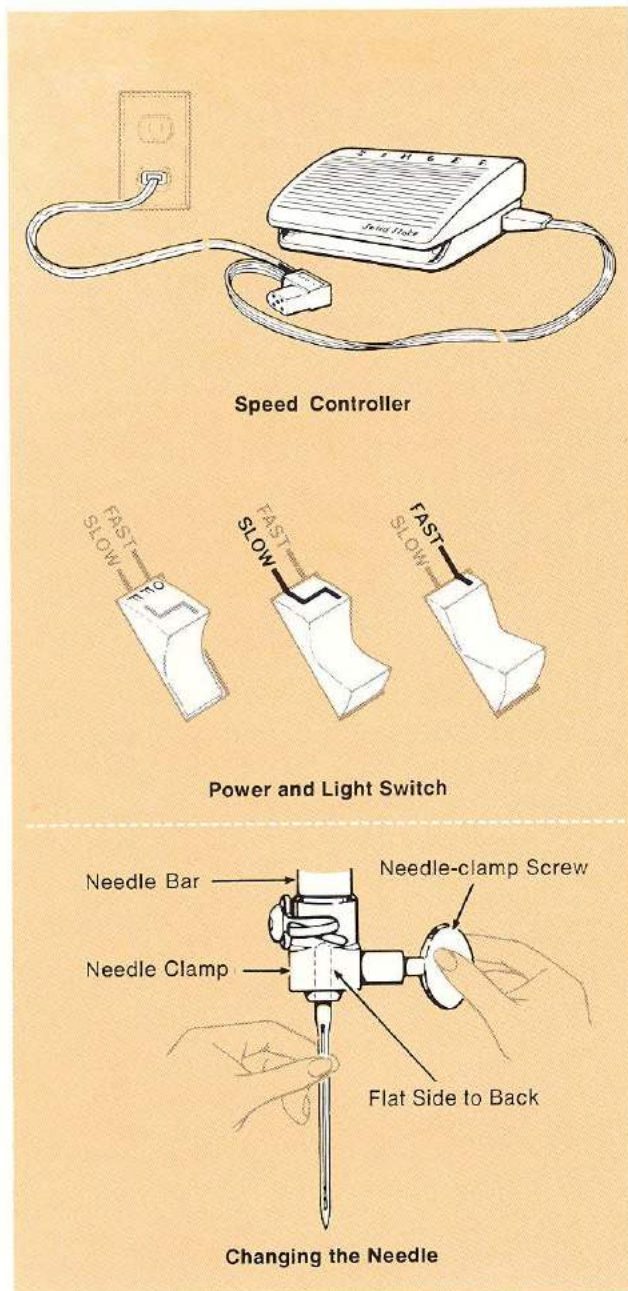

SPEED CONTROL

Note: Before plugging in machine, be sure voltage and number of cycles shown by machine socket conform to your electrical power supply.

Push machine plug into machine socket. Connect powerline plug to electrical outlet. To turn on machine and sewing light, and to set speed range, press power and light switch on.

- **SLOW** (switch pressed halfway) allows for maximum control.
- **FAST** (switch pressed all the way) allows for full speed.

CAUTION: We recommend you turn off the power and light switch before changing needles, presser feet or plates and when leaving machine unattended. This eliminates the possibility of starting the machine by accidentally pressing the speed controller.

If at any time you accidentally switch your machine off, make sure you re-select the desired stitch.

To run machine, press speed controller. The harder you press, the faster machine will sew. To stop the machine from sewing, remove pressure from speed controller.

NEEDLES

For best results, use SINGER* needles in your machine. For general-purpose sewing in a wide range of fabrics, use Style 2020 needle, in sizes 9 through 18.

Knits, woven stretch fabrics, bonded vinyls, and elastic require the Style 2045 ballpoint (yellow band) needle for best results.

The twin needle Style 2025 is used exclusively for decorative stitching in light- and medium-weight fabrics.

For sewing leathers, real and simulated, the Style 2032 needle, available for purchase at your Singer Sewing Center, is recommended.

Changing the Needle

Raise needle to highest point by turning the hand wheel toward you. Loosen needle-clamp screw and remove needle. Insert new needle in clamp, which will *only* accept needle when inserted correctly, with flat side of needle to back. Push needle up as far as it will go. Tighten screw.

THREADING THE MACHINE

Threading the Needle

Place spool of thread on horizontal spool pin. If spool being used has a retaining slit, this should be placed against the spool cushion to the right. Select correct spool holder according to type and diameter of spool being used. The diameter of the end of the spool holder should always be larger than that of the spool itself. Press spool holder firmly against spool.



Raise take-up lever to its highest position by turning the hand wheel toward you. Raise presser foot to release tension discs. Lead thread from spool holder and snap it down into guidepost eyelet. Lead thread under rear thread guide, through the pretension and across the slot in the top of the machine.

Note: Dotted lines in illustrations represent path of thread where concealed by machine.

Draw thread **firmly** into tension disc on right of tension separator. Draw thread down right channel and up left channel. Thread take-up lever by guiding thread through slot and into eyelet. Lead thread from take-up lever down through left channel again, follow it diagonally to the end, then into lower thread guides. Thread needle from front to back, drawing about four inches of thread through eye of needle.

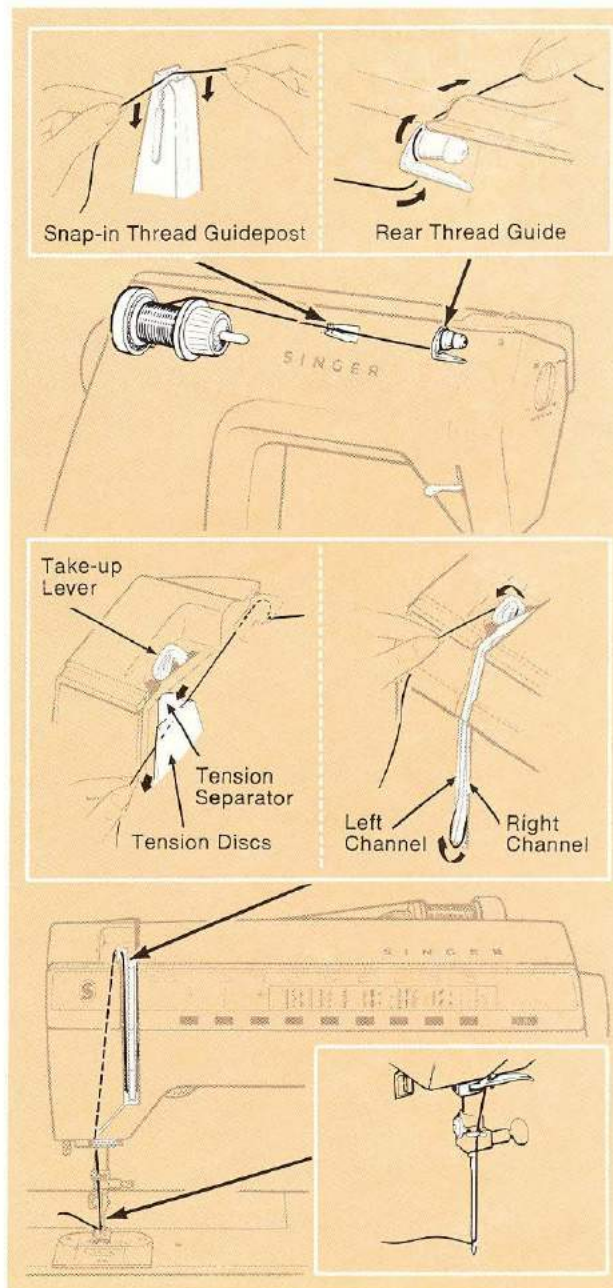

Bobbin Winding Steps

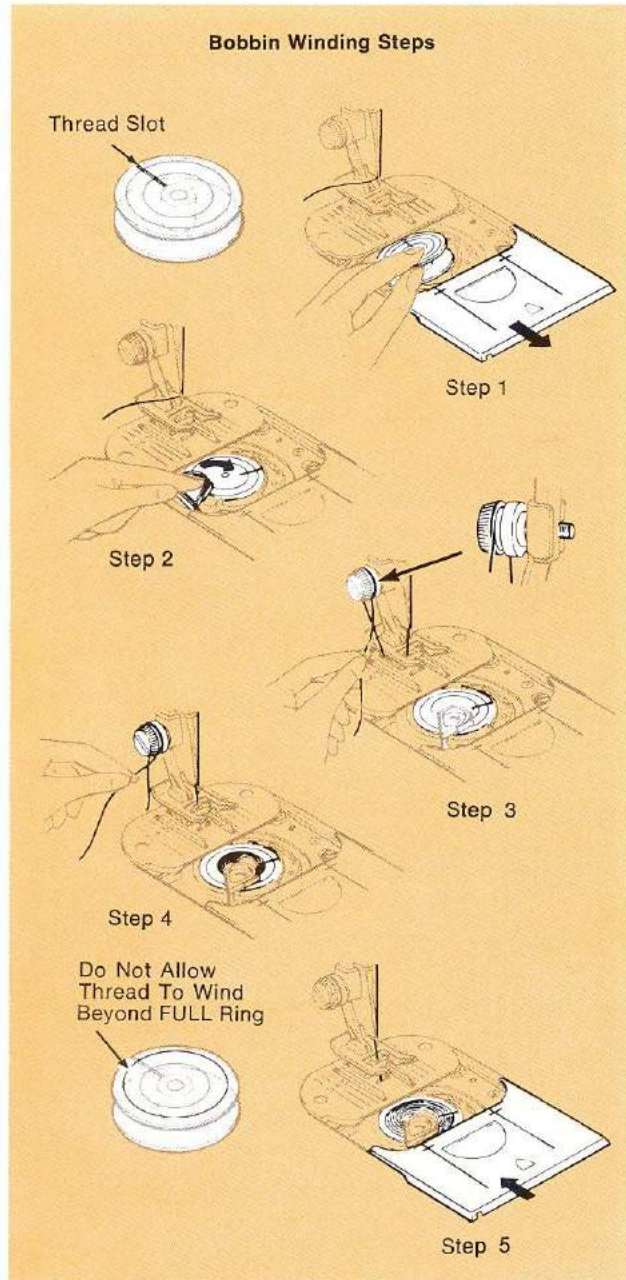

THE BOBBIN

Winding the Bobbin

1. Open slide plate. Move bobbin latch to left. Slip empty bobbin with the slot on top into case. Leave slide plate open until bobbin is wound. Turn on power switch. Press straight-stitch button.
2. Move bobbin latch to right into wind position.
3. Draw needle thread back, under left side of presser foot, then up and around and into thread retainer. Do not hold thread end. Start machine running at moderate speed.
4. Pull thread end away after it has separated from bobbin. Do not allow thread to wind beyond outside FULL ring.
5. Close slide plate. Before starting to sew, pull thread back under presser foot and cut, leaving about four inches.

Removing the Bobbin

Raise take-up lever. Open slide plate; move bobbin latch to left. Remove bobbin by inserting finger under rim.

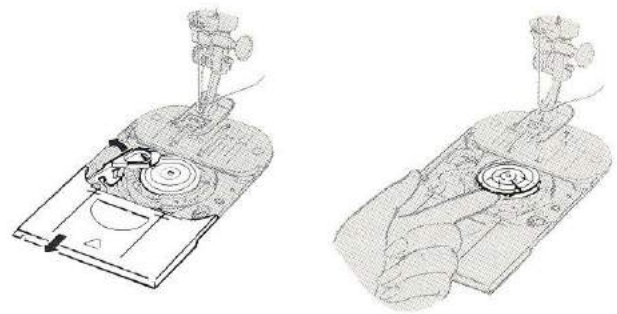

Removing Bobbin

Replacing a Wound Bobbin

Raise take-up lever. Open slide plate; move latch to left. Draw four inches of thread from bobbin and place bobbin in case. Pull thread into slot of bobbin case at Point 1, draw it under flat spring and beyond Point 2. Leave four inches of free thread. Leave slide plate open.

Raising the Bobbin Thread

1. Hold needle thread lightly with left hand and turn hand wheel slowly toward you so needle enters plate.
2. Continue until needle rises. Tighten hold on needle thread and bring up loop of bobbin thread.
3. Open loop with fingers and pull needle and bobbin threads under presser foot diagonally to the left. Close slide plate.

Removing Thread from Bobbin

You can leave the bobbin in place while removing thread. With slide plate closed, pull thread end toward you through plate with a steady motion. Do not pull thread across feed as this may damage feed.

Replacing a Wound Bobbin

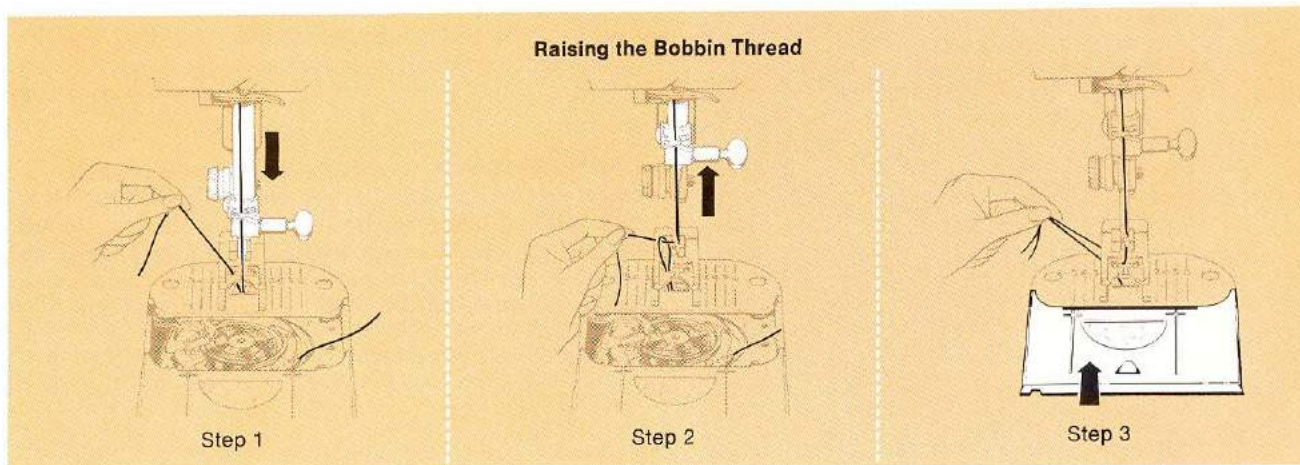
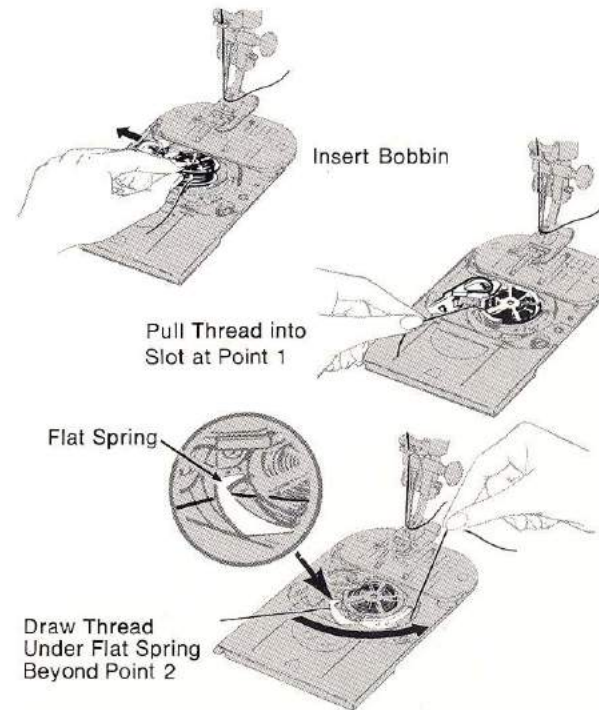

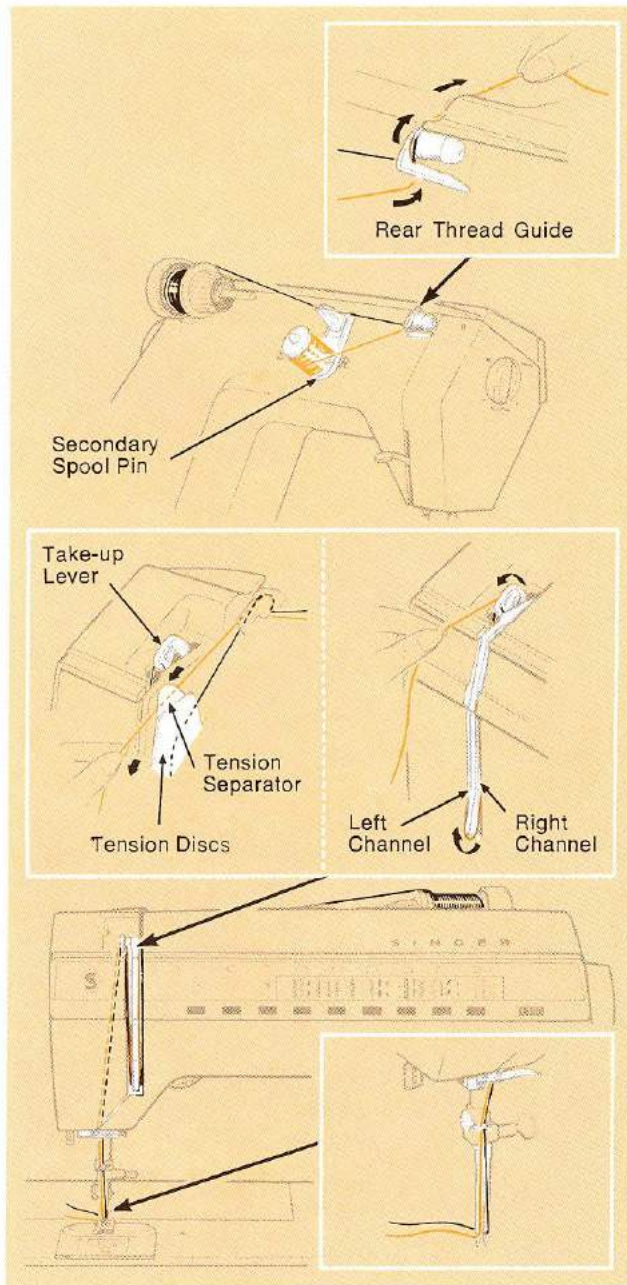



THREADING FOR TWIN-NEEDLE STITCHING

The twin needle simultaneously produces two parallel, closely spaced lines of straight or zig-zag stitching. Effective for decoration, twin-needle stitching is not recommended for seams. Soft fabrics should be sewn with a firm fabric backing or paper backing which can be removed after stitching.

Thread machine with first thread in usual manner, making certain it passes between tension separator and right-hand tension disc. Wind bobbin with enough thread to complete stitching. (Since a bobbin cannot be filled after a twin-needle is inserted, it is wise to keep an extra wound bobbin at hand for replacement.) Unthread and remove needle. Attach secondary spool pin and insert the twin needle. Pass first thread through right eye of needle. Place second spool of thread on secondary spool pin and thread as before, except bypass snap-in thread guidepost and pass thread between tension separator and left-hand tension disc and through left eye of needle.

CAUTION: Always move the twin-needle switch, located on the individual preference panel, to the right () before doing twin-needle sewing. Unless the switch has been activated, needle breakage will result. When you have completed twin-needle sewing, return the switch to the left () position.

REGULATING PRESSURE

The pressure dial regulates the pressure that the presser foot exerts on the fabric. Correct pressure is important to insure that fabric feeds smoothly and evenly. The NORM (normal) setting is an all-purpose setting that can be used for sewing a wide variety of fabrics. Lower the presser foot before setting pressure. To increase pressure, turn the dial from NORM toward MAX (maximum). To decrease pressure, turn the dial from NORM toward #. For darning, set on #.

ADJUSTING THREAD TENSION

The tension dial controls needle-thread tension only. Bobbin-thread tension has been set at the factory. To increase needle-thread tension, turn the dial to a higher number. To decrease tension, turn the dial to a lower number. *Be certain not to accidentally touch pattern selection buttons when adjusting tension. However, if you do so, be certain to re-select desired pattern.*

Correct tension is important because too much or too little will weaken your seams or mar the appearance of decorative work. To obtain the correct tension setting, make a test on a sample of your fabric. If the fabric puckers, decrease tension. If the stitches look loose, increase tension.

LIFTING THE PRESSER FOOT

The presser-foot lifter allows you to raise and lower the presser foot. Extra-high lift position permits easy placement of bulky fabrics. Make sure the lifter is all the way down before starting to sew.

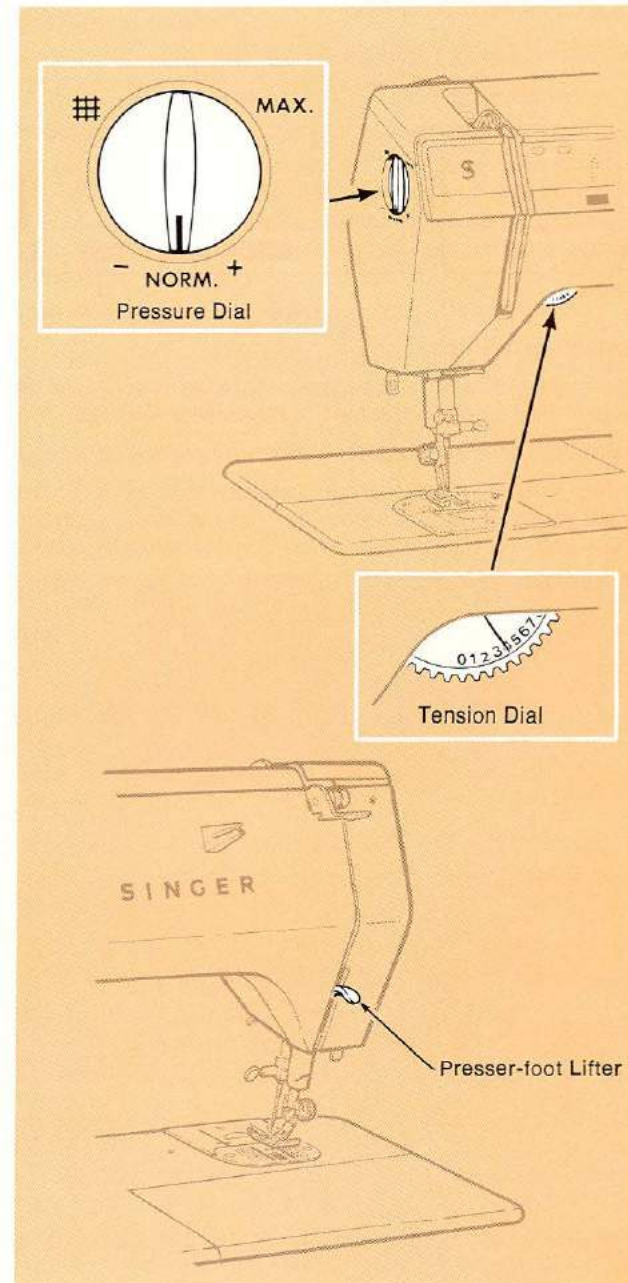

ELECTRONIC SEWING

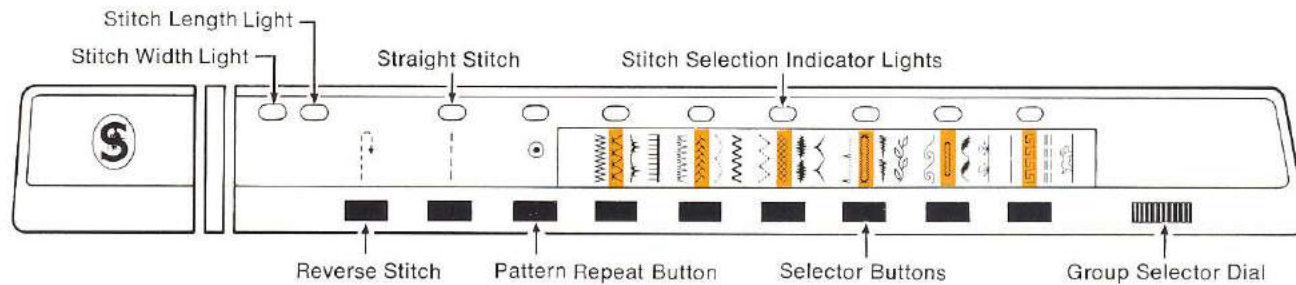

Selecting a Stitch

When you rotate the group selector dial, one of four different groups of patterns is available to you. From this group, you further choose the particular pattern you wish to sew.

Turn your sewing machine on. You will note a slight movement of the needle each time the power switch is activated.

When you rotate the group selector dial as far to the right as it will go, the following patterns are available to you, and will appear yellow on your panel:

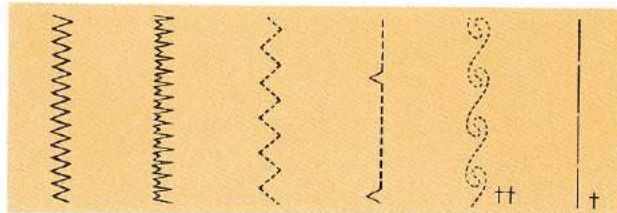

In the third position, these patterns are available:

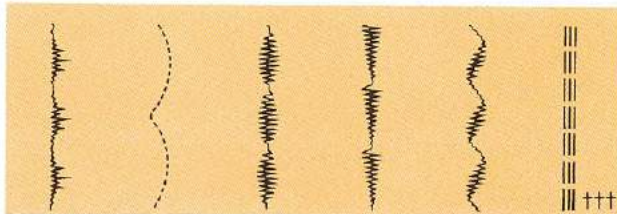

Next, as you rotate the group selector dial to the left, a second group of patterns is made available:

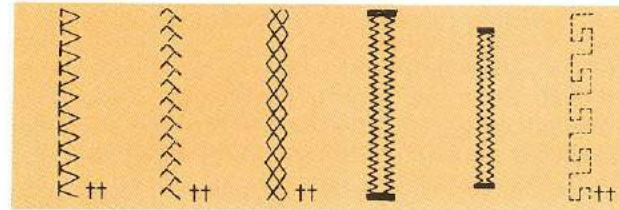

And, in its leftmost position, the group selector dial makes these patterns available:

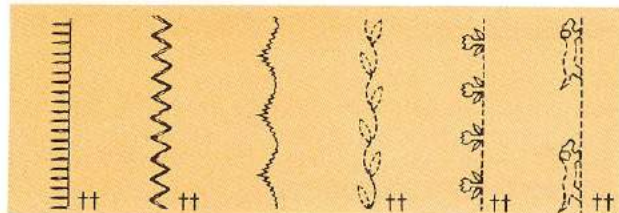

After rotating the group selector dial, press the button under the desired pattern. A red light will appear above the pattern selected. Your machine is now ready to sew the desired pattern. Stitch width and stitch length are automatically programmed, but can be changed to suit individual preferences or fabric requirements, as described on page 14. Follow the same procedure to automatically switch to another pattern.

Note: We recommend use of the SLOW speed setting when you have selected Buttonholes, Basting Stitch, Flexi-Stitch* patterns, or Maxi-Stretch Stitch.

†Basting Stitch

††Flexi-Stitch Patterns

†††Maxi-Stretch Stitch

Straight Stitching

To do straight stitching, simply press the button under the  symbol on the stitch panel. A red light will appear above the symbol, and your machine is programmed to produce a basic straight stitch, suitable for most straight-stitch requirements.

Straight-Stitch Plate and Foot

Best for all straight stitching. Be sure to use these accessories when your fabric requires close control. They are especially helpful for stitching delicate fabrics.

When you use the straight-stitch plate or presser foot, *be sure to set your machine for straight stitching*, to prevent possible needle breakage. However, when you use the *straight-stitch plate*, you get this exclusive feature: If you press another button by mistake, your machine will still sew a straight stitch. Mistake-proof straight-stitch selection.

Pattern Repeat Button

The special pattern repeat button on your machine lets you sew one unit of a pattern — such as one tulip, one dog, and so on. Simply select desired pattern (such as the tulip, shown here), then *also* press the pattern repeat button (⊙ symbol). The red light will appear above the symbol. Press down on controller. Your machine will stitch one unit of the pattern each time you follow this procedure. You can also use the pattern repeat button to stitch a series of identical buttonholes, as described on page 15.

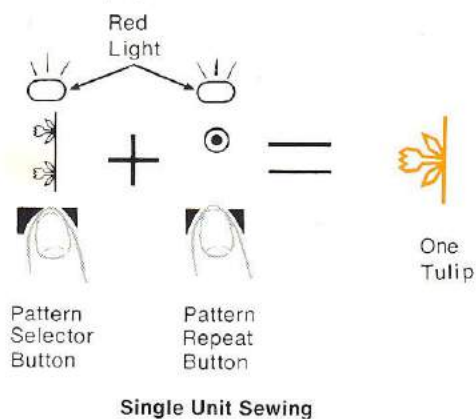

Starting to Sew

Position needle in fabric and lower foot. Start machine by pressing lightly on the speed controller.

Sewing in Reverse

If you wish to reinforce the beginning or end of a seam, touch and hold the reverse button. Your machine will sew a *straight-stitch* in reverse for as long as you hold the button, regardless of the stitch pattern you have been sewing.

Removing Work from Machine

Raise needle and foot. Draw fabric back to the left. Cut threads on thread cutter at rear of presser bar, leaving four inches of thread.

Note: Be sure to raise needle out of fabric when machine is turned off.

Chainstitching

Place bobbin-case insert and chainstitch plate in machine. Thread machine in regular manner, except pass thread through triangular eyelet in take-up lever. Set your machine for *programmed straight stitching only* — do not press any other button and do not adjust stitch width or stitch length.

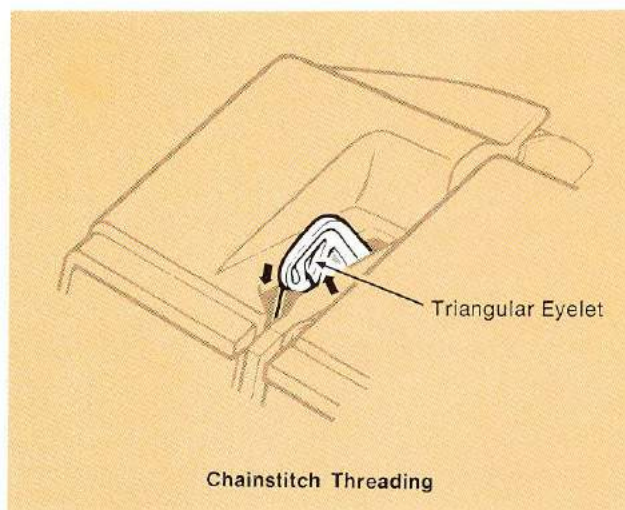

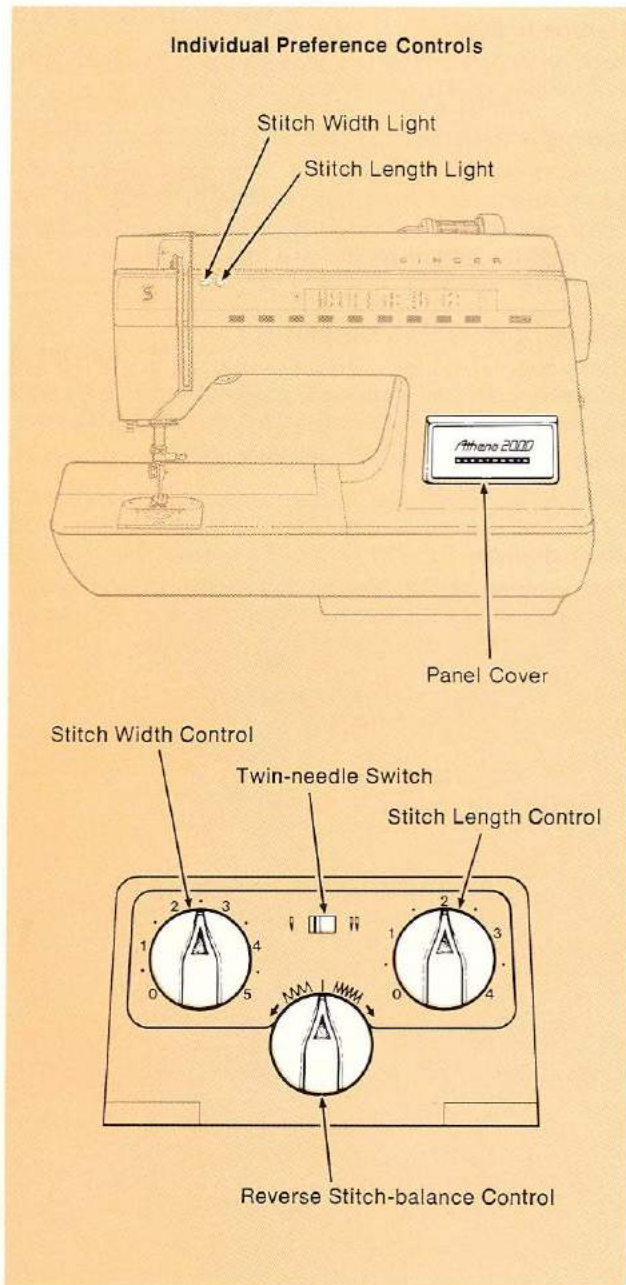

INDIVIDUAL PREFERENCES

Your sewing machine will produce all of your stitching requirements at a programmed stitch width and a programmed stitch length. However, if you wish to accommodate different fabric characteristics or satisfy a personal preference, you can change the settings by opening the cover of the individual preference panel, then manually adjusting the controls located on the panel.

Stitch Width

Select desired pattern, as instructed. Lightly touch the stitch width pointer to activate the stitch width control, indicated by a red light on the stitch panel. Turn pointer until desired width is obtained. Your machine will now stitch at the preferred width.



Stitch Length

Select desired pattern. Lightly touch the stitch length pointer to activate the stitch length control, indicated by a red light on the stitch panel. Turn pointer until desired length is obtained. Your machine will now stitch at the preferred length.

Note: Both stitch width and stitch length controls may be used simultaneously. To cancel, press any button except those for reverse or pattern repeat sewing.

Reverse Stitch-balance

To change the appearance of a *Flexi-Stitch* pattern or buttonholes, adjust the reverse stitch-balance control. Before you move the pointer from its neutral position, make a test sample. If adjustment is required, stitch slowly and move the reverse stitch-balance pointer in either direction, as you sew, until desired pattern appearance is obtained. Return pointer to neutral position after sewing *Flexi-Stitch* patterns and buttonholes.

CAUTION: Always move the twin-needle switch, located on the individual preference panel, **to the right** ( symbol) before doing twin-needle sewing. Unless the switch has been activated, needle breakage will result. When you have completed twin-needle sewing, return the switch **to the left** ( symbol) position.

Note: If, when adjusting a control, you accidentally touch another control, re-select desired pattern, then readjust desired control. Close individual preference panel cover when you have attained desired stitch appearance.

ONE-STEP BUTTONHOLING

Your machine offers you two types of bar-tack buttonholes and two buttonholing methods. For flat buttons up to 1½ inches across, use the one-step method. For best results, we recommend removing underplate from foot when sewing light-weight and knit fabrics, such as thin muslin and nylon tricot.

Determine which buttonhole best suits your garment. Make a test buttonhole on sample of fabric, with interfacing, if being used. Mark start line of buttonhole on garment. Attach zig-zag plate and foot with underplate. Length of buttonhole is set by button-carrier clamp on foot. Put button on carrier and slide clamp back. *Pull down buttonhole lever*, making sure it is between tabs on foot. Draw needle and bobbin threads between foot and underplate to back of machine. Place garment between foot and underplate. Align buttonhole start line on fabric with red guideline on foot. Lower foot. *Pull foot toward you*, assuring engagement of buttonhole lever. Press panel button under buttonhole symbol. Press down on controller. Machine will stop when buttonhole is completed. Remove work from machine, secure and clip thread ends.

Balancing the Density

Make a test buttonhole on a sample of your fabric. As you proceed down the left side of the buttonhole, which is stitched first, you may adjust the density of the buttonhole by turning the *stitch length* pointer. Turning the stitch length pointer toward a higher number opens the stitching on the left side of the buttonhole. Turning the pointer toward a lower number closes the stitching. As you proceed up the right side of the buttonhole, you may adjust the density of the buttonhole by turning the *reverse stitch-balance* pointer. Turning the reverse stitch-balance pointer to the right closes the stitching on the right side of the buttonhole. Turning pointer to the left opens the stitching.

Stitching a Series of Buttonholes

Once you have adjusted buttonhole density, or if the programmed density suits your purpose, you may stitch additional identical buttonholes. Close individual preference panel cover. Push pattern repeat button. Press down on controller. Your machine will stitch one identical buttonhole when you follow this procedure.

Note: Press pattern repeat button *only*. If you accidentally press buttonhole button, readjust individual preference controls.

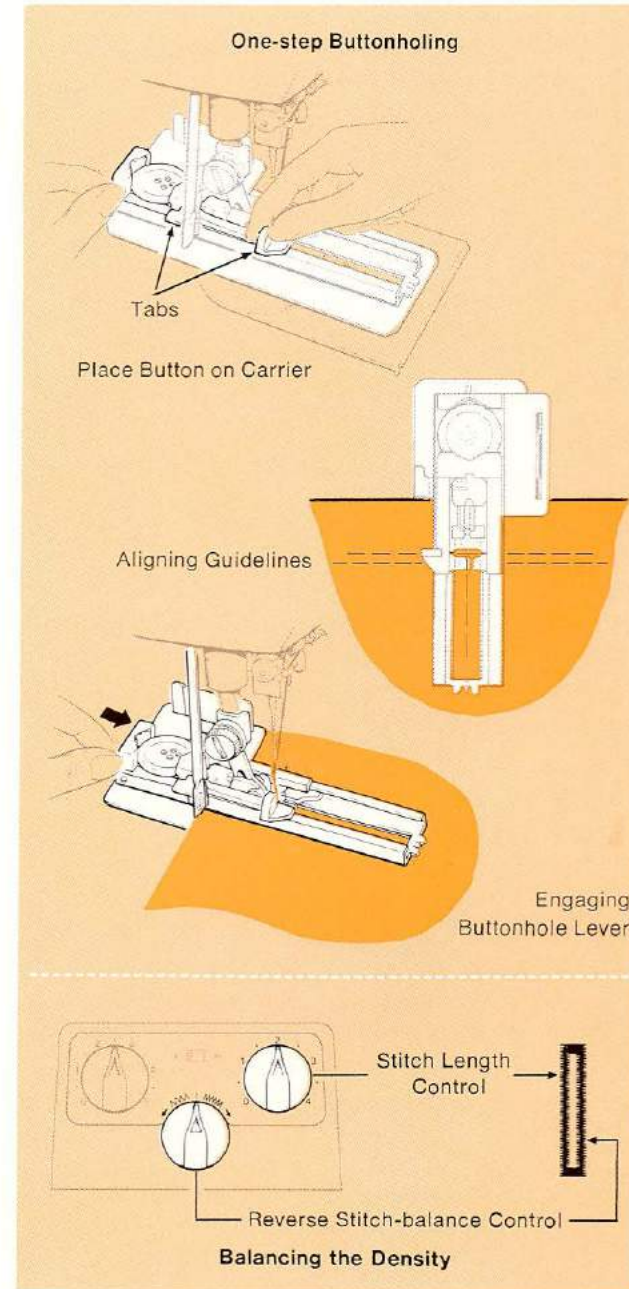

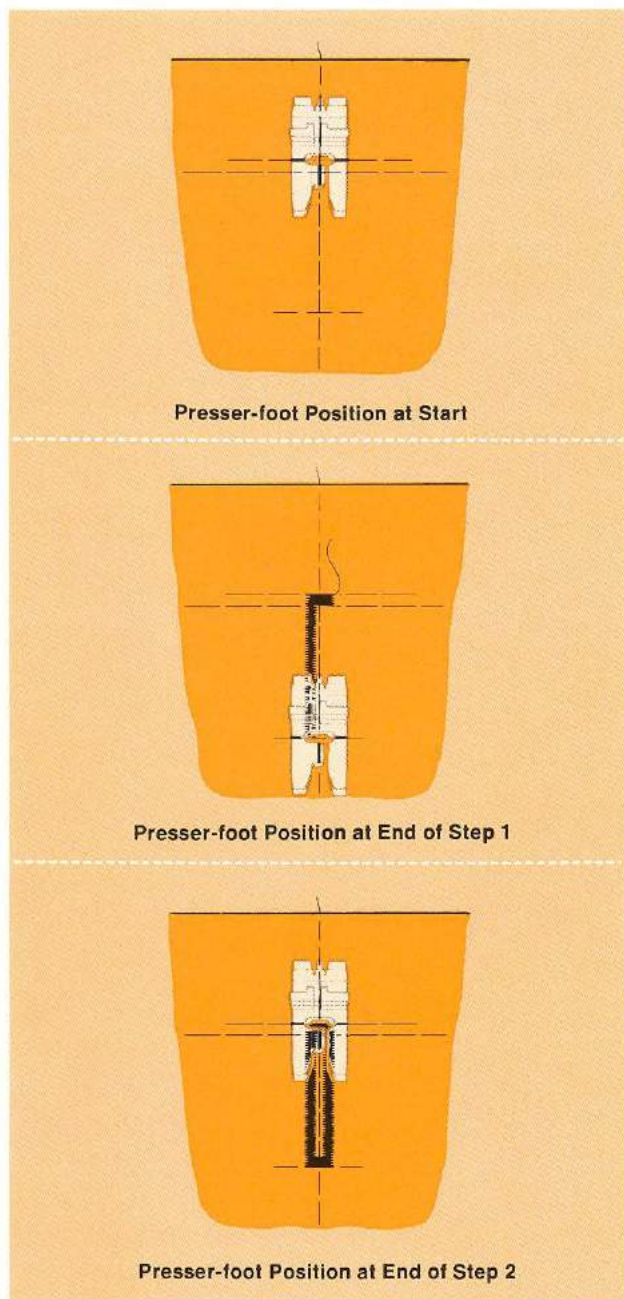

TWO-STEP BUTTONHOLING

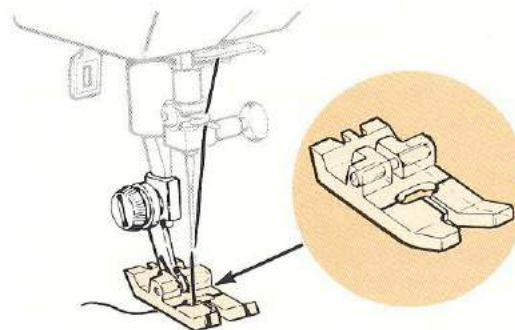

Two-step Buttonhole Foot

For buttons larger than $1\frac{1}{8}$ inches across or for buttons of unusual shape or thickness, use the two-step method of stitching buttonholes.

CAUTION: Do not pull down buttonhole lever.

Always make a test buttonhole on a sample of your fabric, with interfacing, if being used. Determine length of button and mark start and end line of buttonhole on garment. Attach zig-zag plate and two-step buttonhole foot. Draw needle and bobbin threads under foot to back of machine. Place garment under foot so that buttonhole start line is aligned with red guideline on foot. Lower foot. Select required buttonhole by pushing button on stitch selection panel. See directions for one-step buttonholing to balance density of your buttonhole. Start machine and let it complete step 1 of buttonhole cycle. Stop machine *just before* guideline on buttonhole foot reaches end of buttonhole end line on garment. *Press buttonhole lever away from you.* Start machine and let it complete step 2 of buttonhole cycle. Stop sewing when stitching reaches starting bar tack. For additional buttonholes, press the pattern repeat button and follow the same procedure.

For sewing on buttons, see instructions in *Sewing Applications* book.

CORDED BUTTONHOLES

Corded or raised buttonholes are made by stitching over a filler cord. Embroidery or crochet threads make good filler cords, but double strands of sewing thread or a sew-off chain of needle and bobbin thread may also be used.

Inserting Cord in One-step Buttonhole Foot

- Raise foot. Hold filler cord in both hands, and insert it between foot and underplate, from left side (the side opposite underplate tab). Insert one end of the filler cord in the right notch in front of foot. Lead cord back under foot and loop it up and over the cord spur from right to left.
- Bring cord forward, between foot and underplate, and secure end in left notch.

Inserting Cord in Two-step Buttonhole Foot

- With foot up, pass a loop of filler cord around the spur at the back of the foot. Draw ends of cord under the foot and pull taut to secure in spur notches.
- Hold cord ends, as illustrated, during stitching.

Procedure

- Insert cord in buttonhole foot as shown and sew buttonhole in the usual way.
- When stitching is completed, release cord from foot and remove work by drawing it to the back of the machine.
- Draw the loop of filler cord into the buttonhole stitching by holding fabric at the starting end of the buttonhole with one hand and pulling ends of filler cord firmly with the other.
- Trim ends of filler cord.

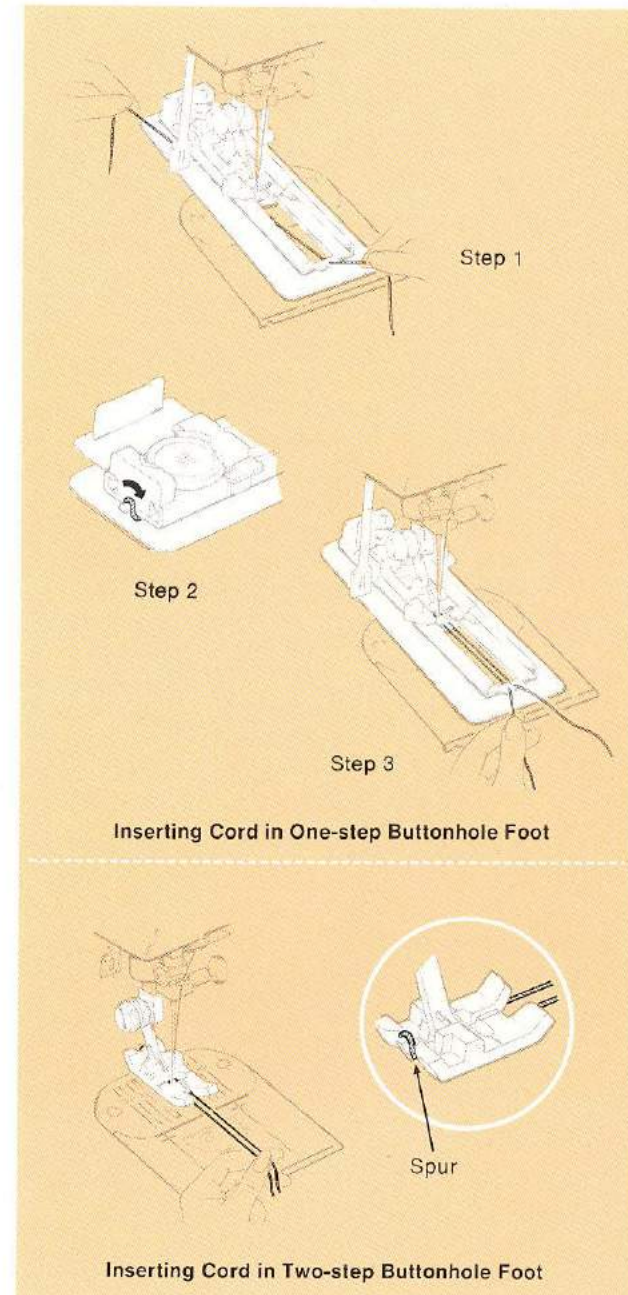

Free-arm Sewing

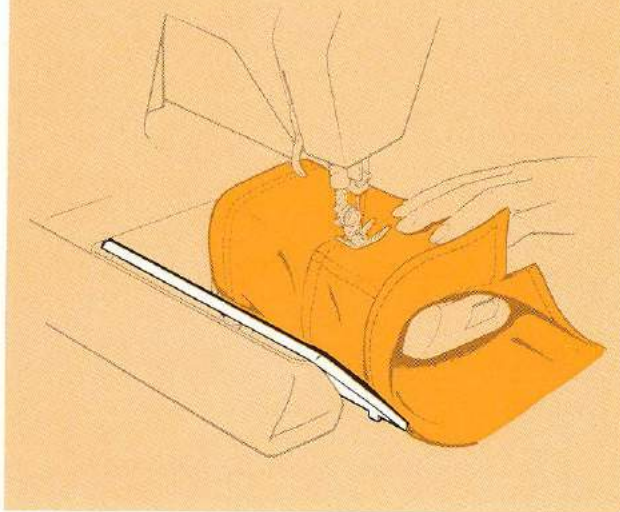
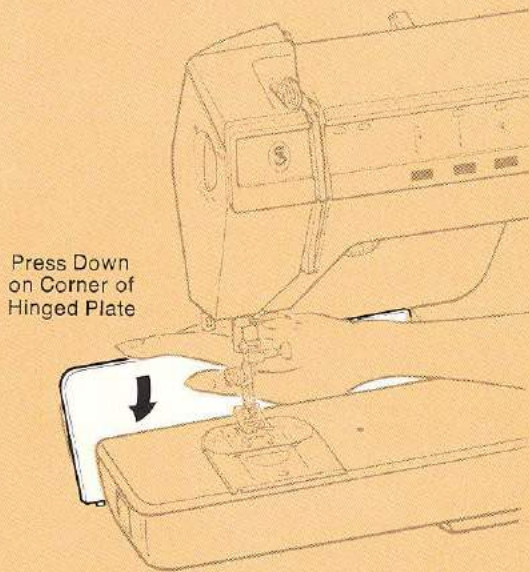

FREE-ARM SEWING

When sewing tubular and hard-to-reach garment areas, fabric handling is simplified when you convert your machine to free-arm sewing. To do this, simply press down on the corner of the hinged plate. To return to flat-surface sewing, raise hinged plate until it snaps into flat-surface position.

CIRCUIT BREAKER

The electronic system of your machine is protected by a circuit breaker. If the sewing light goes on and the needle bar moves up and down, but you cannot select a pattern, you must push the red circuit breaker button, to reactivate the machine. If your machine is a portable model, carefully lift or tilt it to gain access to the button. Push button in. If your machine is secured to a cabinet, reach under front of cabinet and locate the special hole which gives you access to the button. Push button. Certain cabinet models may not have an access hole. In such instances, release the machine from the cabinet, tilt machine, and push button. Re-secure machine to cabinet. Re-select desired pattern.

Note: If button continues to disengage, contact your Singer representative or Approved Dealer.

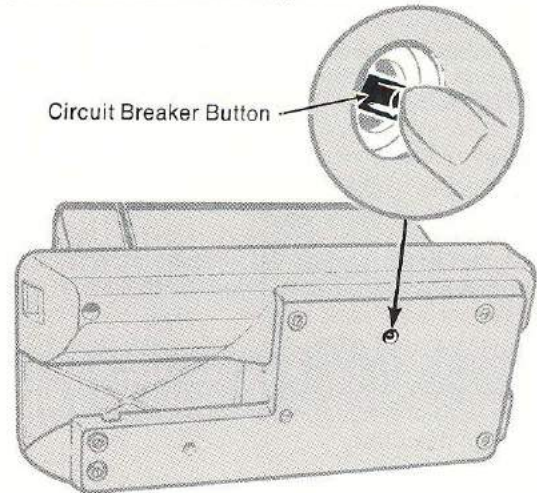

Circuit Breaker

CLEANING THE MACHINE

CAUTION: Before cleaning your machine, disconnect power-line plug from electrical supply.

With a soft cloth or lint brush, clean at points indicated by arrows.

Your machine requires no oiling under normal conditions. Your SINGER representative, or Approved Dealer, will examine the permanently lubricated parts whenever your sewing machine requires servicing.

NOTE: There are no user-serviceable parts inside the *Athena 2000* Electronic Sewing Machine. Therefore any unauthorized tampering inside the machine will void the guarantee.

CHANGING THE LIGHT BULB

This machine is designed to use a 15-watt maximum light bulb. Using thumb and forefinger, pull down on tab located under light lens to lower the light bracket. Do not attempt to unscrew bulb.

CAUTION: Before changing light bulb, disconnect power-line plug from electrical outlet.

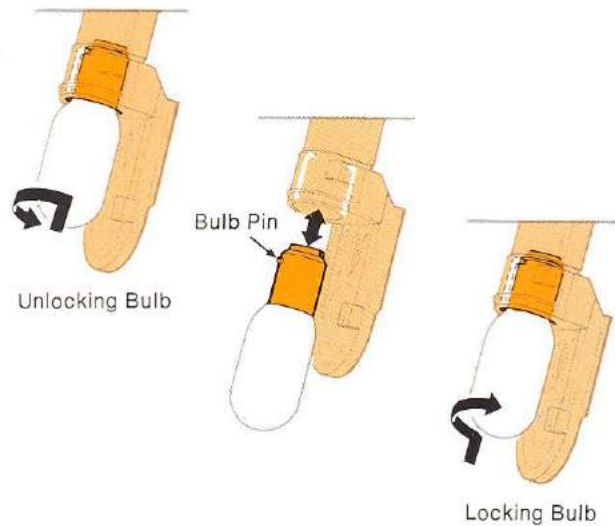

Changing the Light Bulb

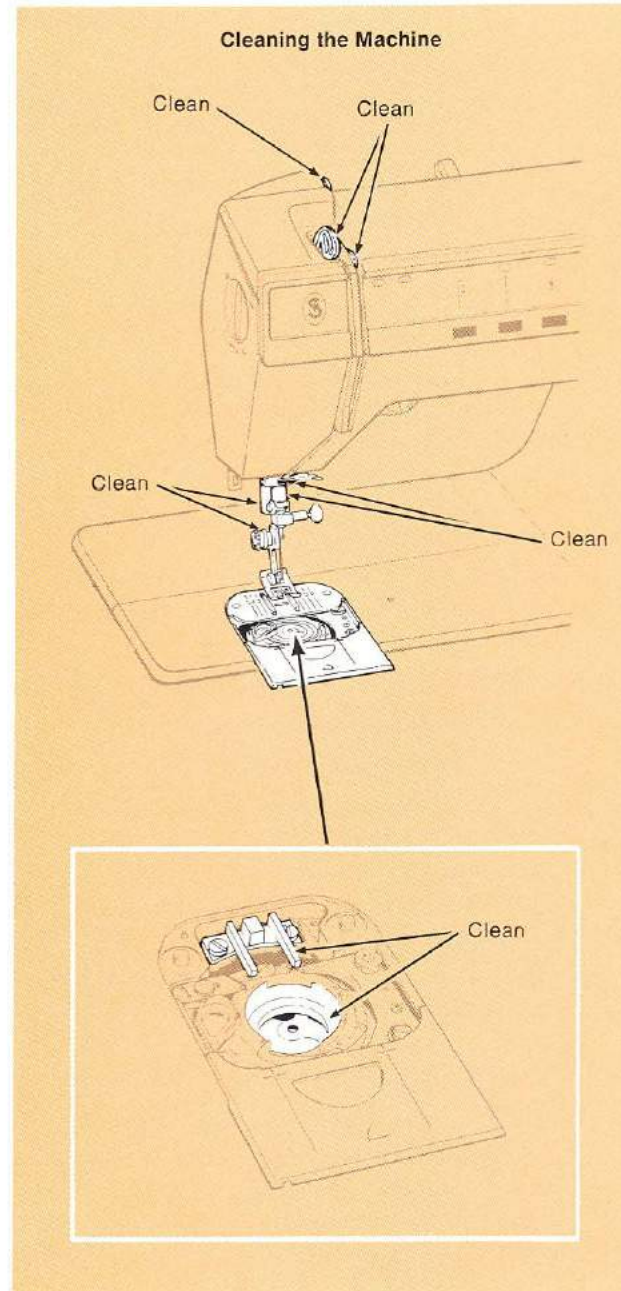

PERFORMANCE CHECKLIST

Should you encounter a sewing problem, review the sewing operation you are performing. If the problem persists, the following hints should help you.

If the machine does not start: make sure . . .

- Machine is connected to electrical supply.
- Power and light switch is on.
- Bobbin has not been wound too full. (Do not wind beyond outer ring on bobbin.) If too full, remove excess thread.

If the sewing light is on and needle bar moves up and down, but the machine does not otherwise operate: make sure . . .

- The circuit breaker is closed.

If the needle bar moves but the stitch is not formed: make sure . . .

- Needle is straight.
- Needle size and style are correct for the thread you are using.
- Machine and needle are correctly threaded.
- Bobbin contains thread.
- Bobbin-case area is free of lint and loose thread ends.

If fabric puckers: make sure . . .

- Needle-thread tension is not too tight.
- Presser-foot pressure is correctly set.

If fabric does not move: make sure . . .

- Presser foot is down and pressure dial is adjusted for the weight and texture of your fabric.
- All lint is removed from around the feed.
- Presser foot or accessory is correctly attached.

If, when returning to single-needle sewing from twin-needle sewing, your machine sews at a reduced stitch width: make sure . . .

- Twin-needle switch is all the way over to the left position.

If stitching is irregular, or needle thread breaks: make sure . . .

- Machine is correctly threaded.
- Thread is even and free of knots.
- Needle is straight and correct size for thread and fabric.
- Spool holder is pressed firmly against thread spool and thread unwinds smoothly from spool.
- Needle-thread tension is not too tight.
- Presser foot is raised for bobbin winding.
- Bobbin case is correctly threaded (when inserting a previously wound bobbin).
- Threads are correctly placed under presser foot when you start to sew.
- Bobbin-case area is free of lint and loose thread ends.
- Bobbin is not damaged.

To prevent needle breakage: make sure . . .

- Twin-needle switch is activated when you do twin-needle sewing.
- Needle is not bent or burred, is the correct style for your machine model, and is the proper size for the thread you are using.
- Needle is fully inserted in needle clamp.
- Presser-foot shank is securely fastened to presser bar.
- Fabric being guided or supported behind the needle is not being pulled too hard.
- Machine is set for straight stitching when you use straight-stitch foot.

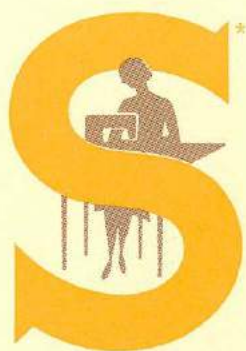

Here, there, everywhere... **SINGER**

*A Trademark of THE SINGER COMPANY

Printed in U.S.A.