

**SINGER**  
127 & 128

INDEX

	PAGE
DESCRIPTION .....	1, 2
ARM SHAFT	
To Remove .....	22, 23
To Install .....	24, 25
ARM ROCK SHAFT	
To Remove .....	25
To Replace and Adjust .....	25
BALANCE WHEEL	
To Remove and Replace .....	18
BINDING OF MOVING PARTS	
To Locate and Correct for .....	26
BOBBIN WINDER	
To Increase the Pressure .....	19
CLAMP STOP MOTION MECHANISM	
To Remove and Replace .....	17, 18
FEED DOG	
The Perfect Lock Stitch (in relation to the feed dog) .....	14, 15
To Set the Feed Dog at the Correct Height .....	16
To Adjust the Position of the Feed Dog in Relation to the Throat Plate Slots .....	17
FEED FORK CONNECTION	
To Remove .....	19, 20
To Replace .....	20
FEED REGULATOR	
To Remove and Replace .....	21
LOCK STITCH FORMATION .....	6, 7
LUBRICATION	
To Oil the Machine .....	3, 4
To Oil a Machine on a Foot Power Stand .....	5
To Lubricate the Motor .....	5
To Oil the Hand-Driving Attachment .....	5
NEEDLE, DESCRIPTION OF .....	8
NEEDLE AND NEEDLE BAR	
To Set the Needle Bar at the Correct Height .....	9
To Correct the Location of the Needle in Relation to the Throat Plate .....	9
To Correct the Location of the Needle in Relation to the Presser Foot .....	10
The Perfect Lock Stitch (in relation to the needle) .....	14, 15
PRESSER BAR	
To Set the Presser Bar at the Correct Height .....	10
PRESSER FOOT	
To Correct the Location of the Needle in Relation to the Presser Foot .....	10
SHUTTLE AND SHUTTLE BOBBIN	
Location (in relation to the needle) .....	8
To Check the Shuttle for Correct Height .....	11
To Adjust the Thread Clearance of the Shuttle .....	11, 12
To Time the Shuttle (without using timing mark on shuttle raceway) .....	12
To Time the Shuttle (using timing mark on shuttle raceway) .....	13, 14
To Time the Shuttle (after installing arm rock shaft) .....	14
The Perfect Lock Stitch (in relation to the shuttle bobbin thread) .....	14, 15
Winding Bobbins Evenly .....	18, 19
STOP MOTION SCREW	
To Adjust for Winding Bobbins .....	17, 18
TAKE-UP SPRING	
To Time the Needle Thread Take-Up Spring .....	15
To Adjust the Tension of the Needle Thread Take-Up Spring .....	15, 16
Exploded View of Take-Up Spring Assembly .....	15
The Perfect Lock Stitch (in relation to the tension of the take-up spring) .....	14, 15
TO "RUN-IN" THE MACHINE .....	26

TO ALL WHOM IT MAY CONCERN:

The improper placing or renewal of the Trade Mark "SINGER" or any other of the Trade Marks of The Singer Manufacturing Company (all of which are duly Registered Trade Marks) on any machine that has been repaired, rebuilt, reconditioned, or altered in any way whatsoever outside a SINGER factory or an authorized SINGER agency is forbidden.

20322

# ADJUSTERS MANUAL

FOR

# SINGER\*

## SEWING MACHINES

OF

# CLASSES 127 and 128

## VIBRATING SHUTTLE

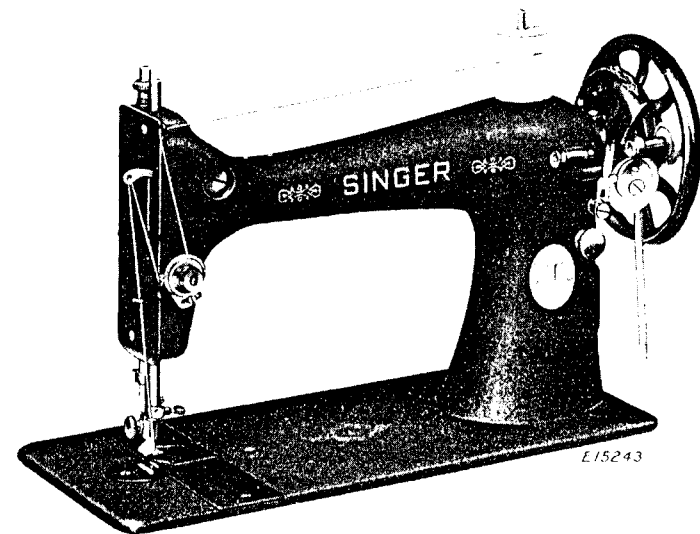

MACHINE 127-12

\*A TRADE MARK OF

THE SINGER MANUFACTURING COMPANY

Copyright, U. S. A., 1915, 1923, 1924, 1931, 1932,  
1940 and 1951 by The Singer Manufacturing Company  
All Rights Reserved for All Countries

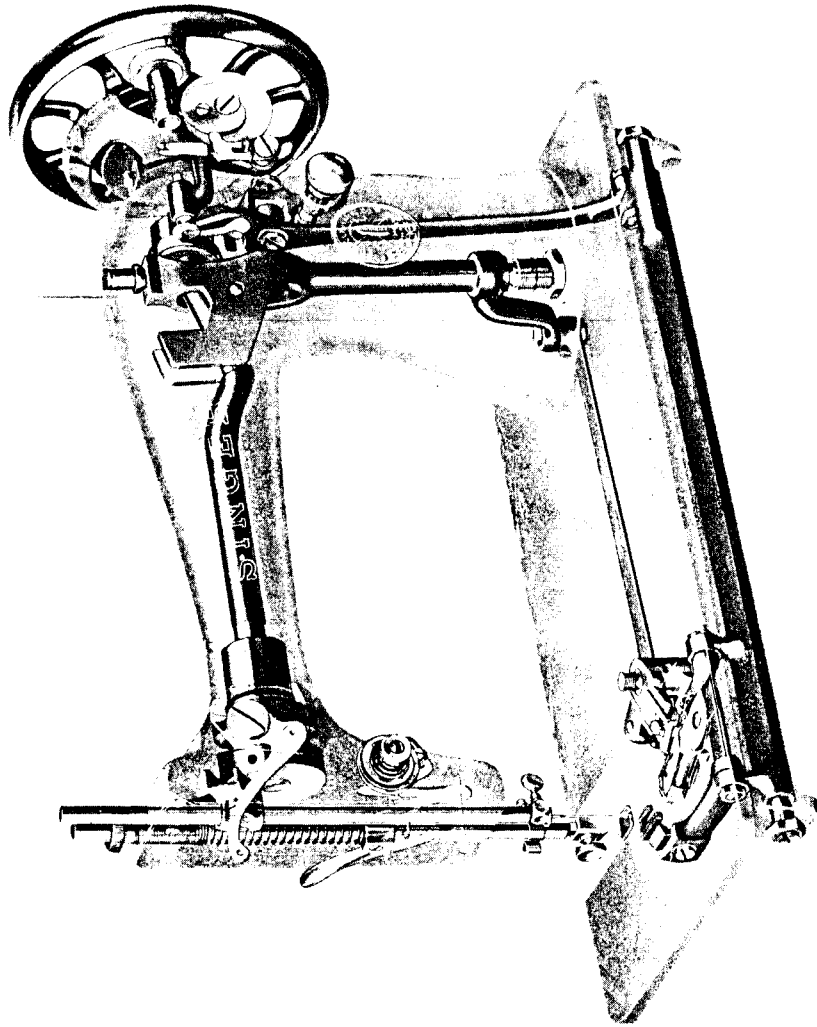

X-RAY VIEW OF MACHINE OF CLASS 127

## DESCRIPTION

Machines of Classes 127 and 128, for family use, have a vibrating shuttle, drop feed, and make the lock stitch.

Machines of Class 128 are smaller than Machines of Class 127. For example:

	Class 127	Class 128
Length of bed	14 $\frac{5}{8}$ inches	12 $\frac{5}{16}$ inches
Width of bed	7 inches	6 $\frac{9}{16}$ inches
Space at right of needle	8 inches	6 $\frac{1}{2}$ inches

All machines in Classes 127 and 128, except Machine 128-8, have a friction type bobbin winder attached to the belt cover. On Machine 128-8 this bobbin winder is attached to the front of the upright part of the machine arm.

Directly beneath the balance wheel on the upright part of the machine arm, on all varieties of these machines except Machine 128-8, a bracket seat is provided for attaching a motor or a hand attachment. This seat is at the rear of the arm on Machine 128-8 and can only be used in attaching a motor.

The shuttle pitman screw stud (eccentric) is set differently on Machines of Class 127 than on Machines of Class 128, in timing the shuttle. See pages 13 and 14. All other adjustments are the same for machines of both Classes.

Machines 127-1 and 127-3, intended for operation by foot power and regularly equipped with a treadle stand, are identical to each other. They have a **spoked** balance wheel, a thread cutter, a needle thread take-up lever cover and a shuttle ejector. These machines are finished in black japan lacquer, with bed ornamentation #15 (Sphinx), #16 (Rose), #177 (Pearl), #317 (Scroll), #318 (Colored) or #492 (Gilt).

Machines 127-2 and 127-4 are identical to each other and are similar to Machines 127-1 and 127-3 except that they are fitted with a hand attachment.

Machine 127-12, intended for foot power, and Machine 127-14, fitted with a hand attachment, are regularly equipped with a **spoked** balance wheel, a thread cutter and a shuttle ejector but are without a needle thread take-up lever cover. Finished in black wrinkle, they have bed ornamentation #492 or #506 (Gilt).

Machine 127-13 is similar to Machine 127-3, except that it is regularly furnished with a BT or BR motor and SINGERLIGHT\*. It is finished in black japan with bed ornamentation #318 or #492.

Machine 127-23, regularly fitted with a BY17 or BZ17 motor and spotlight, for use on a cabinet table, and Machine 127-24, regularly fitted with a BY18 or BZ18 motor and spotlight, for use on a portable bent cover set, are otherwise similar to Machine 127-12 with bed ornamentation #506.

Machine 128-3, designed for operation by foot power and regularly furnished with a treadle stand, has a **spoked** balance wheel, a thread cutter, a shuttle ejector and a needle thread take-up lever cover. It is finished in black japan with bed ornamentation #318.

Machine 128-4 is similar to Machine 128-3 except that it is fitted with a hand attachment. The bed ornamentation is #15, #317 or #485 (Gilt).

Machine 128-8, regularly furnished with a BS motor and spotlight, has **disc** balance wheel, a stitch adjusting lever and stitch indicator but is without the usual thread take-up lever cover and shuttle ejector. It is finished in black wrinkle with bed ornamentation #497 (Gilt).

Machine 128-12, intended for foot power, is similar to Machine 128-3 except that it has no thread cutter, shuttle ejector or take-up lever cover and is finished in black wrinkle with bed ornamentation #497 or #506.

Machine 128-13 is similar to Machine 128-3 except that it is furnished with a BT motor and SINGERLIGHT and has bed ornamentation #318 or #485.

Machine 128-14 is similar to Machine 128-12 except that it is regularly equipped with a hand attachment.

Machine 128-18, for use on a cabinet table, is similar to Machine 128-12 except that it is regularly furnished with a BY17 or BZ17 motor and spotlight, **disc** balance wheel and bed ornamentation #497.

Machine 128-23, for use on portable bent cover set, is similar to Machine 128-12 except that it is regularly furnished with a BY8, BY9, BZ8 or BZ9 motor and spotlight, **disc** balance wheel and bed ornamentation #497 or #506.

## TO OIL THE MACHINE

To insure easy running, the machine requires oiling and, if used continuously, it should be oiled each day. With moderate use, an occasional oiling is sufficient.

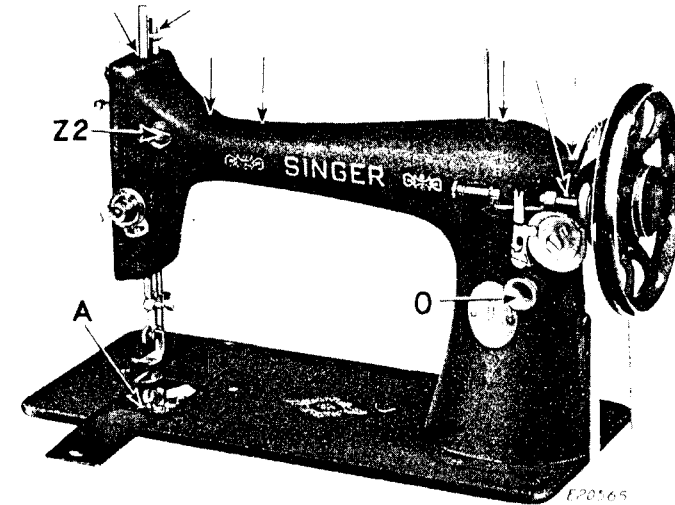

Fig. 2. Front View, Showing Oiling Points

SEWING MACHINE OIL, sold only by Singer Sewing Machine Company, should be applied at each of the places indicated by the unlettered arrows in Figs. 2, 3, 4 and 5. One drop of oil at each point is sufficient. Oil holes are provided in the machine for bearings which cannot be reached directly.

Tip the machine back on its hinges to reach the oiling points underneath the bed.

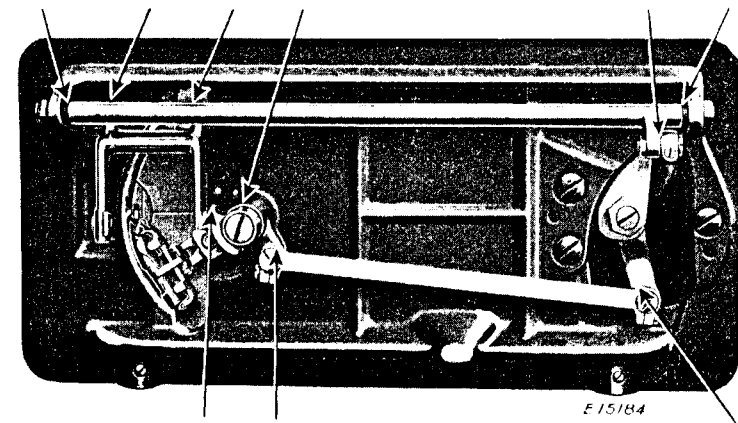

Fig. 3. Underside of Machine, Showing Oiling Points

Remove the face plate and apply a drop of oil at each of the places indicated by arrows in Fig. 4.

Draw out the front bed-slide and remove the accumulated lint and dust, then put a few drops of oil on the wick A, Fig. 2, which is under the slide.

Loosen the thumb screw which holds the cover plate on the back of the arm, turn the plate upward and fasten it by retightening the screw. Turn the balance wheel over toward you **slowly**, by hand, and oil the moving parts inside the arm. Then turn the cover down and fasten it as before.

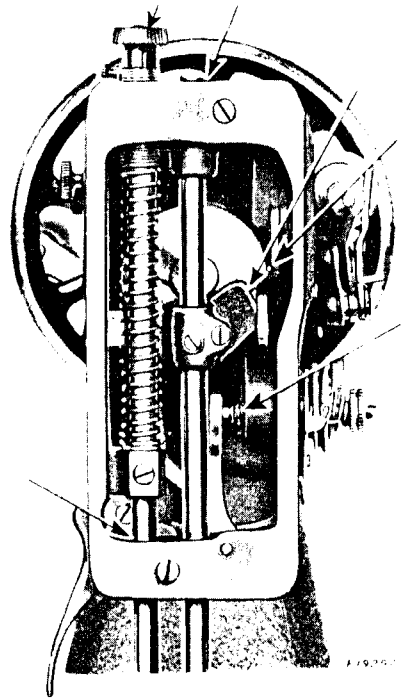

Fig. 4. End View, Showing Oiling Points

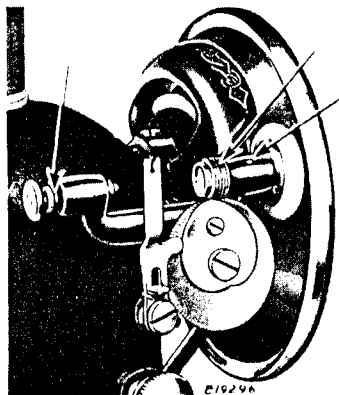

Fig. 5. Oiling Points on the Bobbin Winder

Apply a drop of oil at each of the points on the bobbin winder, indicated by arrows in Fig. 5.

To reach the parts underneath the bed, when the machine is used on a **foot power stand**, simultaneously press the belt shifter to the left and operate the treadle until the belt is released, then tip the machine back on its hinges. After applying oil at each of the places indicated by the arrows in Fig. 3, oil each of the bearings in the stand.

#### TO OIL THE HAND-DRIVING ATTACHMENT

Apply a drop of **SEWING MACHINE OIL**, sold only by Singer Sewing Machine Company, at each of the oil holes in the hand-driving attachment as shown by the arrows in Fig. 6.

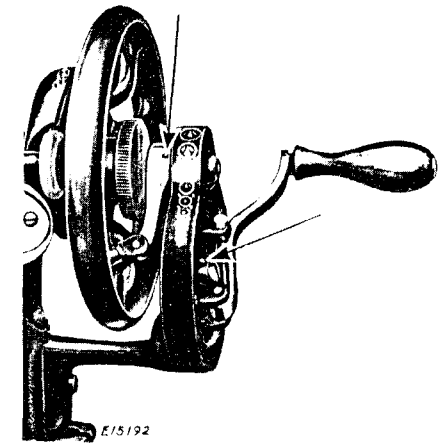

Fig. 6. Oiling Points in Hand-Driving Attachment

#### TO LUBRICATE THE MOTOR ON ELECTRIC MACHINES OF CLASSES 127 AND 128

##### IMPORTANT

**DO NOT USE OIL** anywhere on the motor. Use **MOTOR LUBRICANT**, sold only by Singer Sewing Machine Company.

The grease tubes **B**, Fig. 7 on the motor are filled at the factory with enough grease for about six months ordinary use.

At least once every six months thereafter, refill these grease tubes with **MOTOR LUBRICANT**.

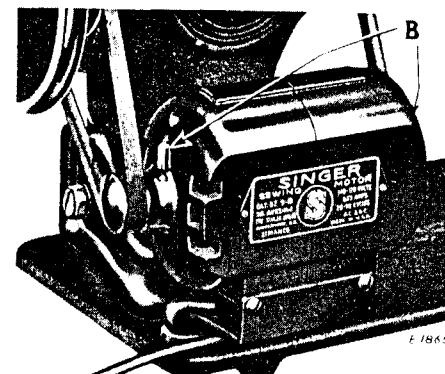

Fig. 7. Lubricating the Motor

## FORMATION OF THE LOCK STITCH

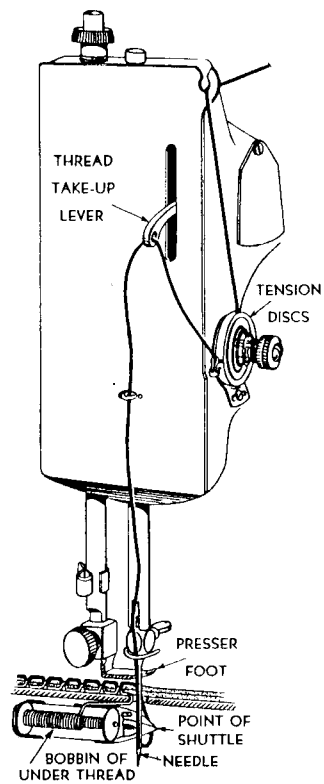

Fig. 8. Point of Shuttle Entering Loop of Needle Thread

Fig. 8 shows the first stage in stitch formation. The thread leading to the needle is loosened, because the thread take-up lever has begun its descent; the needle, after having descended to its lowest point, has been slightly raised. A loop of thread is thus formed which is immediately entered by the point of the shuttle.

Fig. 9 shows the second stage. The shuttle containing the bobbin of under thread has fully entered the loop of needle thread, sufficient enlargement of the loop having been permitted by the descent of the thread take-up lever.

The shuttle travels to and fro in a carrier to which it is not fastened, but by which it is held in position. During the forward movement of the shuttle the loop of needle thread slips between the shuttle and the carrier, then passes out between the heel of the shuttle and the rear part of the carrier. The shuttle thread is thus enclosed in the loop of needle thread and both threads are then drawn up by the action of the thread take-up lever.

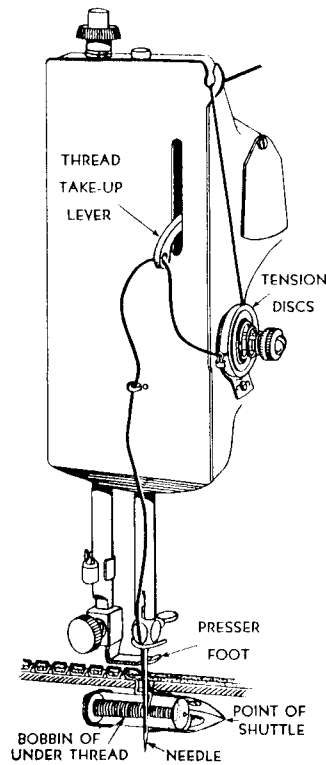

Fig. 9. Shuttle in Loop of Needle Thread

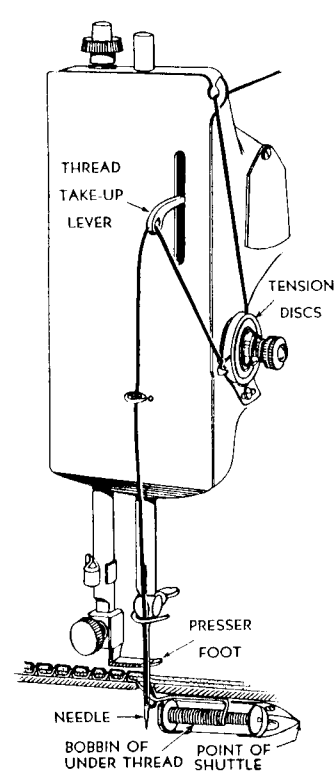

Fig. 10. Shuttle Thread Enclosed by Needle Thread

Fig. 10 shows the third stage. The shuttle has passed through the loop of needle thread, the shuttle thread has been enclosed by the needle thread, and the thread take-up lever is being raised to tighten the stitch.

Fig. 11 shows the stitch completed. The thread take-up lever has been raised to its highest point, drawing the needle thread, together with the shuttle thread, into the middle of the fabric, the two threads now being locked. The tension on the needle thread is regulated by the circular tension discs shown in the illustrations, and the tension on the under thread is regulated by a spring on the shuttle.

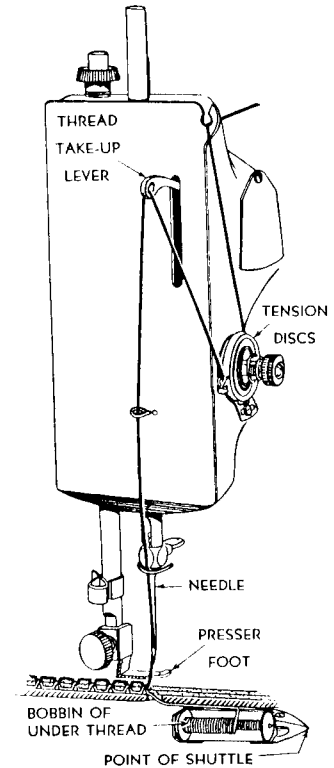

Fig. 11. Stitch Completed

### DESCRIPTION OF 15 x 1 NEEDLES MACHINES 127 AND 128

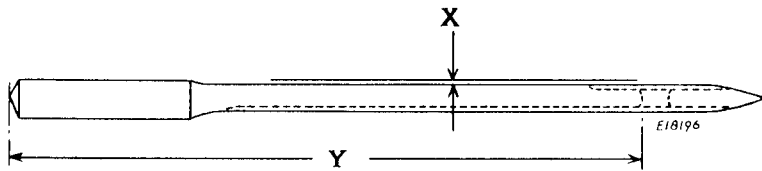

Fig. 12. Needle Distances

Needles for Machines of Classes 127 and 128 are of Class and Variety 15 x 1 and are made in Sizes 9, 11, 14, 16, 18, and 19.

Although needles are made in different sizes, there are certain dimensions that remain constant for all needles of the same Class and Variety. For example, the clearance X, Fig. 12, between the short-groove side of the needle and the position of the flat-side of the needle shank, seated in the needle bar, is constant, maintaining an identical relationship between the shuttle point and all 15x1 needles. Therefore, any increase in the circumference of the needle blade can only be toward the long-groove side. See also Figs. 13 and 15.

Another constant is the distance Y, Fig. 12, from the top of the needle shank to the top of the needle eye, which determines the position of the needle eye during the formation of the thread loop. Also the particular shape of the needle point must be maintained for uniformity of stitch formation. However, the size of the needle eye should increase with the size of the needle, accommodating the heavier thread in use. For these reasons, any increase in the length of a 15 x 1 needle is made from the top of the needle eye toward the point of the needle.

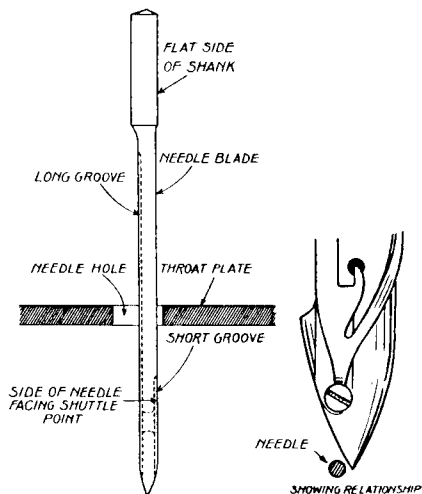

Fig. 13. Showing Relative Position of Needle to Shuttle and to Needle Hole in Throat Plate

### POSITION OF SHUTTLE POINT IN RELATION TO NEEDLE

The needle should be as close as possible to the shuttle point, without interfering with the shuttle point, as shown in Fig. 13.

This setting is necessary in order to prevent breaking of threads or skipping of stitches.

If the needle is too far away from the shuttle, the needle or the needle bar may be bent or the shuttle may be worn. After replacement of damaged parts, further adjustment may be made on the height of the needle bar, as described on page 9.

### TO SET THE NEEDLE BAR AT THE CORRECT HEIGHT

To check the height of the needle bar, remove the needle and turn the balance wheel over toward you until the needle bar is at its lowest position.

When the needle bar is in this position, the distance from the bottom of needle stop screw C, Fig. 14, to the top of the throat plate should be approximately  $1\frac{3}{16}$  inch, as shown in Fig. 14.

If the needle bar is not set at the correct height, loosen the two screws D, Fig. 14 and raise or lower the needle bar as required, then securely tighten the screws D.

Unless the needle bar is bent or worn, the range of this adjustment (approximately  $\frac{1}{2}$  inch) is usually sufficient.

When the needle bar cannot be adjusted as described above, the needle bar, needle bar cam, roller and stud should be checked for need of replacement.

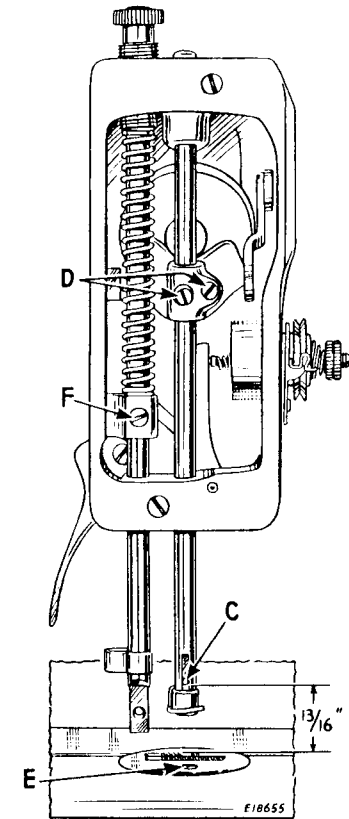

Fig. 14. Setting the Needle Bar

### TO CORRECT THE LOCATION OF THE NEEDLE IN RELATION TO THE THROAT PLATE

When the needle enters the needle hole in the throat plate, the short-grooved side of the needle should be close to the right side of the needle hole, as shown in Figs. 13 and 15. This location of the needle leaves sufficient clearance for the needle thread, as the size of the needle increases toward the left.

At no time should the needle either touch the edge of the needle hole or locate in the center of the needle hole.

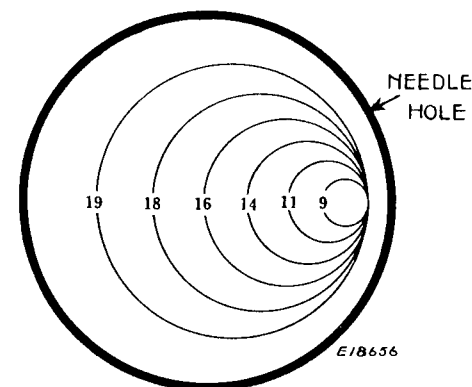

Fig. 15. Location of Needle in Relation to Throat Plate and Relative Positions of Each Size of Needle

When the needle is located incorrectly in the needle hole of the throat plate, check for the following causes:

1. Bent needle, worn or damaged needle bar. (Replace).
2. Dirt clogged needle seat in needle bar. (Clean).
3. Incorrectly seated throat plate. (Adjust).

The throat plate may be adjusted after loosening throat plate screw **E**, Fig. 14.

### TO SET THE PRESSER BAR AT THE CORRECT HEIGHT

When the presser foot is raised, there should be a clearance of  $\frac{5}{16}$  inch between the presser foot and the throat plate.

At this setting and with the needle bar set at the correct height, neither the needle bar nor the needle clamp can strike the presser foot.

To set the presser bar at the correct height, raise the presser bar lifter to its highest position, loosen the set screw **F**, Fig. 14 and raise or lower the presser bar as required. Then, after locating the presser foot in relation to the needle, as described below, retighten the set screw **F**.

### TO CORRECT THE LOCATION OF THE NEEDLE IN RELATION TO THE PRESSER FOOT

When the needle is at its lowest position, the short-grooved side of the needle should be near the short toe of the presser foot, as shown in Fig. 16.

At no time should the needle either touch the presser foot or locate midway between the long and short toe of the presser foot.

When the needle is located incorrectly in relation to the presser foot, check for the following causes:

1. Bent needle, worn or damaged needle bar or presser bar. (Replace).
2. Dirt clogged needle seat in needle bar. (Clean).
3. Presser bar out of adjustment. (Adjust).

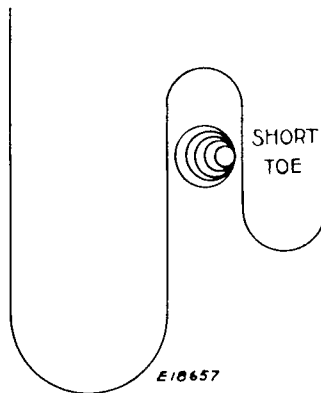

Fig. 16. Location of the Needle in Relation to the Presser Foot

### TO CHECK THE SHUTTLE FOR CORRECT HEIGHT

Before checking the shuttle, check the needle bar for correct height, as described on page 9. Then put the needle up into the needle bar as far as it will go, and turn the balance wheel over toward you until the shuttle point reaches the center of the needle.

In this position, the shuttle point should be  $\frac{1}{16}$  inch above the top of the needle eye, as shown in Fig. 17.

If the shuttle is set too high, it may strike the bed slide, and if the shuttle is set either too high or too low in relation to the needle eye, it may interfere with the proper formation of the stitch.

When the shuttle is not at the correct height, check for wear and need of replacement of bell crank hinge screw, bell crank **N**, Fig. 23 and shuttle carrier arm **R**, Fig. 23. After new parts are installed, it still may be necessary to bend the shuttle carrier arm **R** close to the shuttle carrier bell crank **N**. This should be done very carefully.

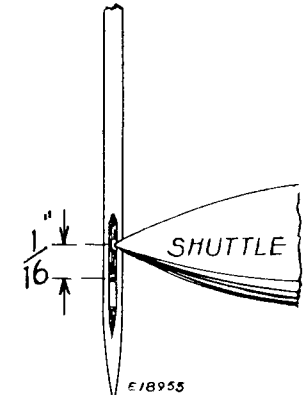

Fig. 17. Showing Shuttle at the Correct Height

### TO ADJUST THE THREAD CLEARANCE OF THE SHUTTLE

Using Narrow Feeler Gauge Serial 187928

To check the thread clearance of the shuttle, pull out the front bed slide and turn the balance wheel over toward you until the shuttle **G**, Fig. 18, is at the end of its stroke away from the operator. Then using narrow feeler gauge **H**, Fig. 18 (with leaves .015 and .018 inch thick), check thread clearance of shuttle at the four points shown in Figs. 18, 19, 20, 21.

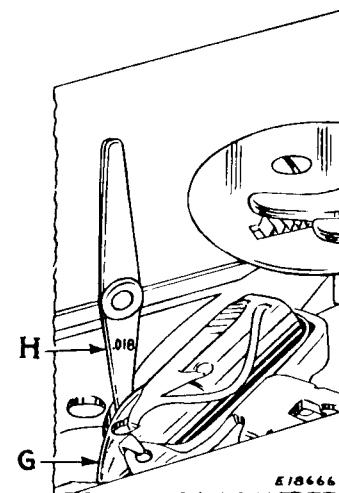

Fig. 18. Checking Thread Clearance between Shuttle Point and Shuttle Raceway

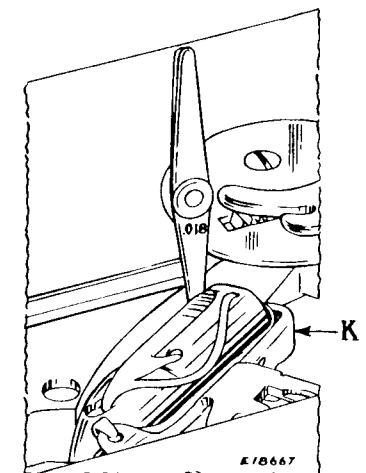

Fig. 19. Checking Thread Clearance at Shuttle Heel



**NOTE:** Feeler Gauge leaf .015 inch thick should slip freely, while Feeler Gauge leaf .018 inch thick should fit snugly at each position indicated.

To adjust the thread clearance between the shuttle and the shuttle raceway, loosen the screw **L**, Fig. 23 in the shuttle carrier bell crank **N**, Fig. 23 and move the shuttle carrier **K**, Figs. 19 and 23 as required.

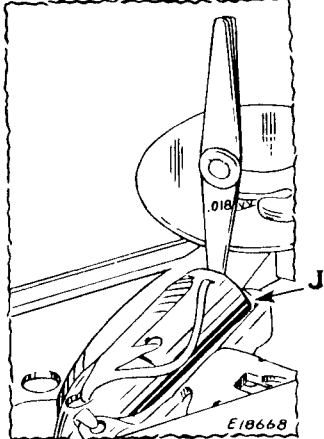

Fig. 20. Checking Thread Clearance between Shuttle Heel and Shuttle Carrier Spring

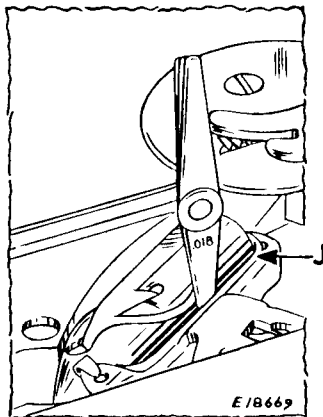

Fig. 21. Checking Thread Clearance between Shuttle Body and Shuttle Carrier Spring

To adjust the thread clearance between the shuttle heel and the shuttle carrier spring **J**, Fig. 20, check for wear and need for replacement of bell crank **N**, Fig. 23 and hinge screw. After new parts are installed, it still may be necessary to bend the shuttle carrier spring **J** slightly, using special pliers, Serial 169596. To correct the clearance between shuttle body and spring (see Fig. 21), try resetting spring after loosening screw **L**, Fig. 23.

### TO TIME THE SHUTTLE

**On Machines Which Do Not Have a Timing Mark on the Shuttle Raceway**

Before timing the shuttle, check the needle bar for excessive up or down play, due to wear of needle bar cam and roller. Replace when necessary. Then set the needle bar and the shuttle at the correct height, as described on pages 9 and 11 respectively, and check the thread clearance of the shuttle, as described above. Then place the machine upside down on a machine jack.

To check the timing of the shuttle, turn the balance wheel over toward you until the needle, after reaching its lowest point, rises approximately  $\frac{3}{32}$  inch. At this time, the point of the shuttle should be at the center of the needle blade, as shown in Fig. 22.

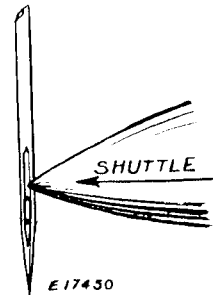

Fig. 22. Showing the Shuttle Correctly Timed in Relation to the Movement of the Needle

To time the shuttle properly loosen the nut **S**, Fig. 24, using wrench Serial 161323, and turn the eccentric stud **T**, Fig. 24 over to the right until the point of the shuttle reaches the center of the needle blade. Then while firmly holding the stud **T** in position, retighten the nut **S**.

Check the shuttle carrier **K**, Fig. 23 while it is in motion, for proper clearance with the bed slide, throat plate, etc. If the carrier strikes the bed slide during its stroke or strikes the feed carrier at the end of its stroke, it should be inspected for wear and need of replacement.

### TO TIME THE SHUTTLE

**On Machines Which Have a Timing Mark on Shuttle Raceway**

Before timing the shuttle, check the needle bar for excessive up or down play, due to wear of needle bar cam and roller. Replace when necessary. Then set the needle bar and the shuttle at the correct height, as described on pages 9 and 11 respectively, and check the thread clearance of the shuttle, as described on pages 11 and 12. Then place the machine upside down on a machine jack.

To check the timing of the shuttle, turn the balance wheel over toward you until the needle reaches its lowest position, as shown in Fig. 23. At this time, the point of the shuttle **G**, Fig. 23, should be at the center of the timing mark **M**, Fig. 23, on the shuttle raceway.

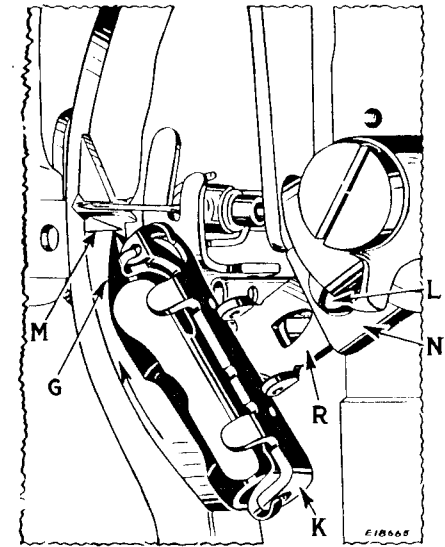

Fig. 23. Shuttle Adjustments (Machine Upside Down on Machine Jack)

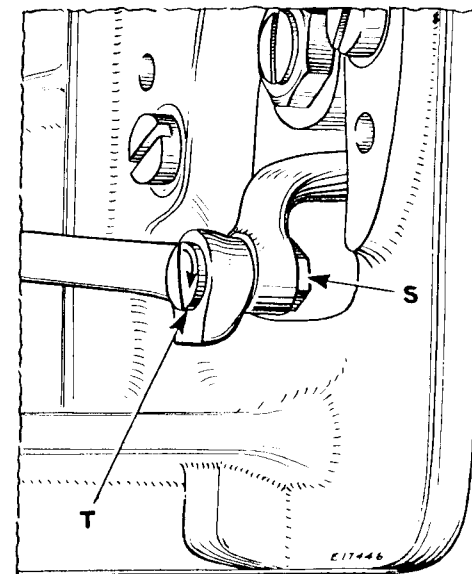

Fig. 24. Timing the Shuttle (Machine Upside Down on Machine Jack)

**For Machines of Class 127:**

To time the shuttle properly, loosen the stud nut **S**, Fig. 24, using wrench Serial 161323, and turn the shuttle pitman eccentric stud **T**, Fig. 24, over to the right (as shown by the curved arrow in Fig. 24), until the point of the shuttle **G** reaches the center of the timing mark **M**. Then, while firmly holding the stud **T** in position, retighten the nut **S**.

**For Machines of Class 128:**

If the shuttle is not correctly timed, proceed as outlined for Machines of Class 127, see page 13, except first turn the eccentric stud T, Fig. 24, counter-clockwise until the high point of the eccentric, see Fig. 26, is as near as possible to the operator's side of the machine.

**TO TIME THE SHUTTLE AFTER INSTALLING ARM ROCK SHAFT**

After an arm rock shaft has been installed, time the shuttle in the following manner:

**For Machines of Class 127:**

Turn the shuttle pitman screw stud (eccentric) T, Fig. 24, clockwise until the high point of the eccentric, see Fig. 25, is as far as possible from the operator's side of the machine. It may be necessary to turn the eccentric back and forth at the high point, until the point of the shuttle locates at the center of the needle. At this time the point of the shuttle should be  $\frac{1}{16}$  inch above the eye of the needle as shown in Fig. 17.

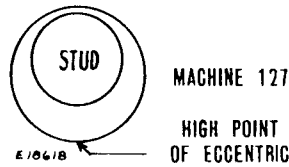

Fig. 25. Eccentric Position (127 Machine Upside Down on Machine Jack)

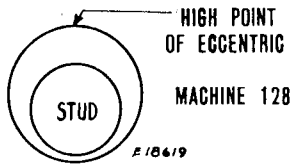

Fig. 26. Eccentric Position (128 Machine upside down on Machine Jack)

**For Machines of Class 128:**

Turn the stud (eccentric) T, Fig. 24, counter-clockwise until the high point of the eccentric, see Fig. 26, is as near as possible to the operator's side of the machine. Then proceed in the same manner as outlined for Machines of Class 127.

**THE PERFECT LOCK STITCH**

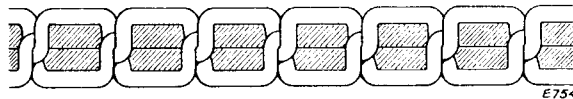

Fig. 27. Cross Section View of Perfect Lock Stitch

When the tensions of both the needle thread and the bobbin thread are correctly adjusted the stitches should be locked in the center of the thickness of the material, as shown in Fig. 27 above.

When the tension of the needle thread is set **TOO TIGHT** in relation to the bobbin thread, excess bobbin thread is drawn to the top of the material causing a loose stitch, as shown in Fig. 28 below.

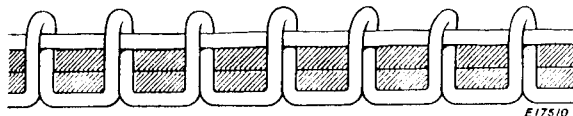

Fig. 28. Cross Section View of Loose Stitch

When the tension of the needle thread is set **TOO LOOSE** in relation to the bobbin thread, sufficient bobbin thread is drawn into the material causing a shortened, puckered stitch, as shown in Fig. 29 below.

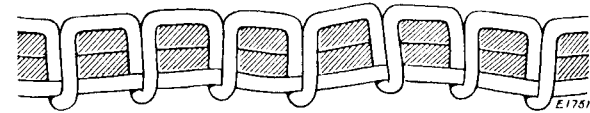

Fig. 29. Cross Section View of Shortened Stitch

**TO TIME THE NEEDLE THREAD TAKE-UP SPRING**

When the eye of the needle reaches the material on its downward stroke, the needle thread take-up spring U, Fig. 30 should complete its action and rest against stop V, Fig. 30 on the thread take-up spring regulating plate W, Fig. 30.

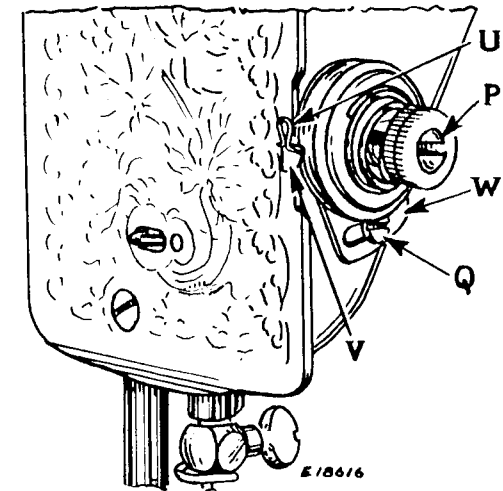

Fig. 30. Adjustment of the Take-Up Spring

To adjust the timing of the take-up spring U, loosen the regulating plate adjusting screw Q, Fig. 30 and move regulating plate W either toward the right to complete its action later or toward the left to complete its action earlier. Then securely tighten adjusting screw Q.

**TO ADJUST THE TENSION OF THE NEEDLE THREAD TAKE-UP SPRING**

The tension of the needle thread take-up spring U, should be sufficient to take up the slack of the needle thread and retain it until the eye of the needle reaches the material on its downward stroke.

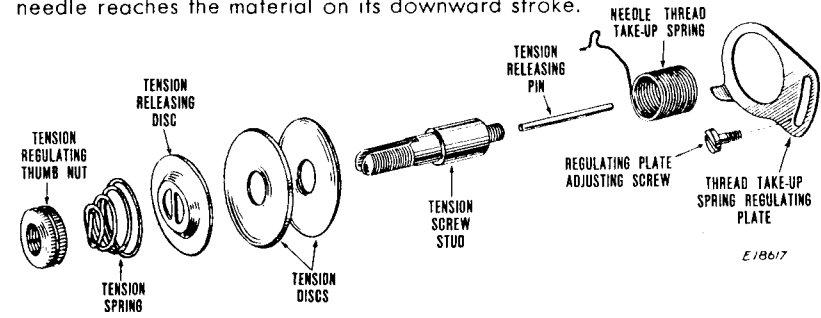

Fig. 31. Exploded View of Needle Thread Take-Up Spring Assembly

**CAUTION:** The tension on the needle thread should be regulated only when the presser foot is down.

To adjust the tension of the take-up spring **U**, loosen the tension screw stud **P**, Fig. 30, releasing ALL TENSION on the take-up spring; then move the eyelet end of the take-up spring **U** over the stop **V** and wind the spring counter-clockwise. The degree of tension on the needle thread is determined by the distance the spring **U** is turned counter-clockwise from the stop **V** before the stud **P** is securely retightened. After the stud **P** is retightened, return the eyelet end of the take-up spring clockwise until it rests upon the stop **V**.

### TO SET THE FEED DOG AT THE CORRECT HEIGHT

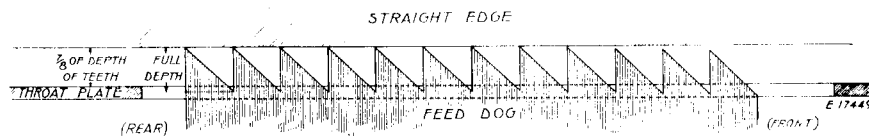

Fig. 32. Showing Feed Dog at Correct Height

To check the height of the feed dog, set the stitch regulator **O**, Fig. 44, page 20 for the longest stitch and turn the balance wheel over toward you until the feed dog is raised to its highest point. In this position approximately seven eighths of the depth of the rear teeth of the feed dog should project above the top surface of the throat plate, as shown in Fig. 32.

To adjust the height of the feed dog, loosen the set screw **Z**, Fig. 33 under the bed of the machine and raise or lower the feed dog as required. Then securely tighten set screw **Z**.

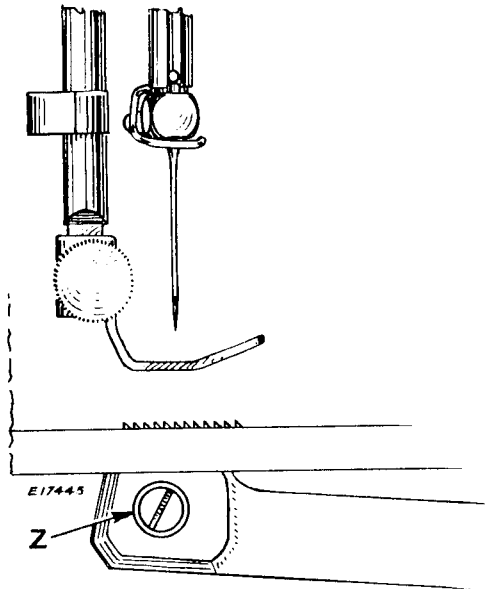

Fig. 33. Feed Dog Adjustment

### TO ADJUST THE POSITION OF THE FEED DOG IN RELATION TO THE THROAT PLATE SLOTS

The feed dog should be set in the feed dog slots in the throat plate so that it is as close as possible to the needle hole, when the machine is set for the longest stitch, without touching the edges of the slots.

To adjust the **sidewise** position of the feed dog, tip the machine back on its hinges, loosen the two nuts **A2**, Fig. 34 and turn the two center screws **B2**, Fig. 34 as required. Then securely tighten the nuts **A2**.

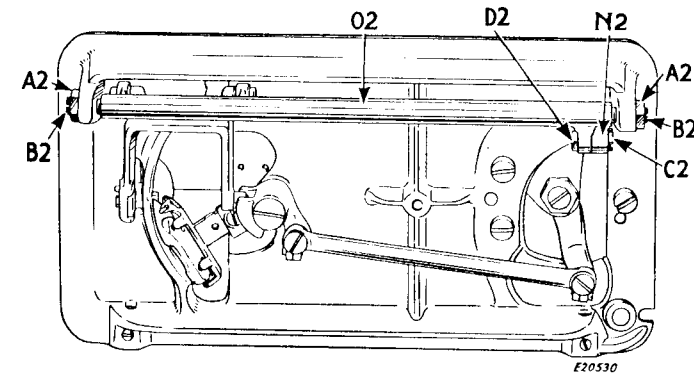

Fig. 34. Adjusting the Feed

The feed dog should be set **lengthwise** in relation to the throat plate slots so that its movement is equidistant from the front and rear ends of the throat plate slots.

To adjust the **lengthwise** position of the feed dog, loosen the nut **D2**, Fig. 34 and turn the eccentric screw **C2**, Fig. 34, as required. Then securely tighten the nut **D2**.

### TO ADJUST THE STOP MOTION SCREW FOR WINDING BOBBINS

In order to operate the bobbin winder without running the stitching mechanism, it is necessary to release the stop motion mechanism in relation to the balance wheel. To release the stop motion, hold the balance wheel and turn the stop motion screw **G2**, Fig. 36, over toward you as shown in Fig. 35.

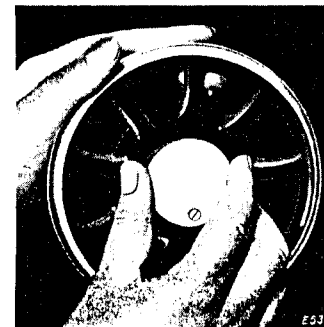

Fig. 35. Releasing the Stop Motion

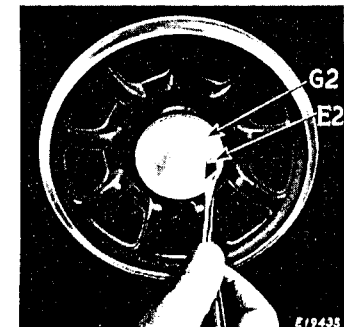

Fig. 36. Loosening the Stop Screw

If the machine continues to run after the stop motion clamp screw **G2** has been released, remove it by loosening the small screw **E2**, Fig. 36, which holds it in place, take off the clamp screw **G2**, as shown in Fig. 37, and inspect the parts for wear, dirt, or hardened grease. Examine the position of the clamp washer **H2**, Fig. 38. The two inner prongs are not flat, but are bent outward on one side. The correct position of the clamp washer **H2** is against the balance wheel hub **with the inner prongs in the slots of the bushing, but projecting outward** to make contact with the clamp screw. When the washer is incorrectly inserted, with the two inner prongs projecting toward the bushing, the clamp stop motion will not release the sewing mechanism.

Before replacing the clamp stop motion washer **H2**, remove the balance wheel and check for hardened oil, burrs on bushing or projecting taper pin. Dress down burrs with a fine file. Remove hardened oil with a wire brush or with steel wool. Lubricate the bushing and replace balance wheel. Replace washer **H2** as described above.

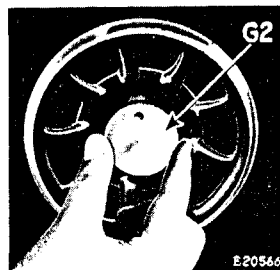

Fig. 37. Removing the Clamp Screw

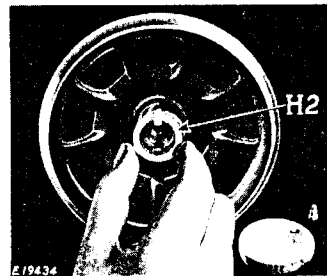

Fig. 38. Removing the Clamp Washer

Sometimes it is found necessary to change the position of the washer by giving it a half turn before replacing the clamp screw.

#### TO ADJUST THE BOBBIN WINDER TO WIND THE BOBBIN EVENLY



Fig. 39. Bobbin  
Incorrectly Wound



Fig. 40. Bobbin  
Correctly Wound

A bobbin must be wound evenly to work properly in the machine. Great care should be taken in winding a bobbin to have the thread placed on the bobbin smoothly and evenly, and the bobbin should never be wound so full that it is tight in the shuttle. A correctly wound bobbin (see Fig. 40) will insure a smooth-running thread from the shuttle and will prevent an uneven stitch which may occur if the thread is placed on the bobbin unevenly as shown in Fig. 39.

When the thread winds to one side of the bobbin, check the thread guide for wear at the cam (following) end and replace when necessary with a new guide.

When a new guide tends to wind the thread unevenly on the bobbin, bend the thread guide, which carries the thread from the bobbin winder to the bobbin, away from the side at which the thread piles up. Use a pair of pliers #26346, as shown in Fig. 41. Care should be taken not to bend the thread guide too far.

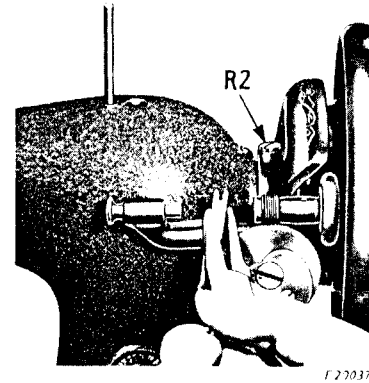

Fig. 41. Adjusting Thread Guide

#### TO INCREASE THE PRESSURE ON THE BOBBIN WINDER

If the pressure of the rubber ring against the hub of the balance wheel is not sufficient to wind the bobbin, tighten nut **F2**, Fig. 42.

If the rubber ring becomes worn or if oil has been allowed to come in contact with the rubber, the ring will not have the proper contact with the wheel and will slip when attempting to wind a bobbin. A worn or oily ring should be replaced.

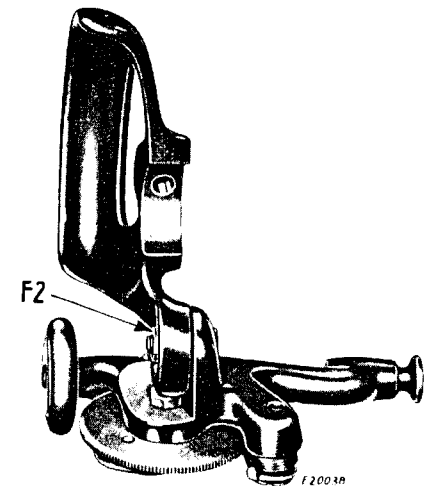

Fig. 42. Adjusting Pressure on Bobbin Winder

#### TO REMOVE THE FEED FORK CONNECTION

To remove the feed fork connection, first remove the eccentric screw **C2**, Fig. 34 and nut **D2**, Fig. 34, disengaging the feed fork connection **N2**, Fig. 34, from the feed rock shaft **O2**, Fig. 34.

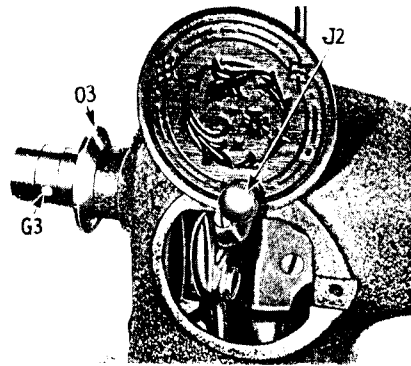

Fig. 43. Arm Side Cover Open

### TO REPLACE THE FEED FORK CONNECTION

To replace the feed fork connection, first make certain that the set screw **K2**, Fig. 45 is loose so that it does not bind the feed cam to the arm shaft. Then after placing the roller **P2**, Fig. 45, over the stud on the feed fork connection **N2**, Fig. 45, insert the feed fork into the hole in the base of the machine and up into the upright part of the arm, so that the feed forks ride over the feed cam **Q3**, Fig. 45 and the roller **P2** slips into its slideway on the feed regulator **M2**, as shown in Fig. 45.

Move the feed cam **Q3**, Fig. 45, toward the balance wheel end of the arm shaft as far as it will go. Then back off the feed cam very slightly, so that there is a small amount of play and securely tighten the set screw **K2**, Fig. 45.

Connect the lower end of the feed fork connection **N2**, Figs. 34 and 45, to the feed rock shaft **O2**, Fig. 34, by means of the eccentric screw **C2**, Fig. 34, and the nut **D2**, Fig. 34, as shown in Fig. 34. Replace the arm side cover.

Turn the balance wheel over toward you by hand, several revolutions, to check for binding of parts just installed.

After the feed fork connection is installed, adjust the lengthwise position of the feed dog in relation to the throat plate, as described on page 17.

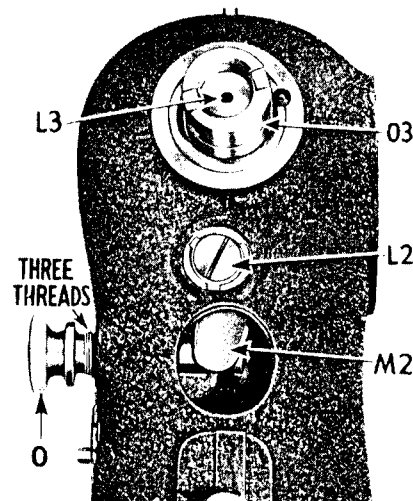

Fig. 44. Replacing Feed Fork Connection

Loosen the thumb screw **J2**, Fig. 43, turn the arm side cover up, as shown in Fig. 43, and retighten the thumb screw **J2**. Loosen the set screw **K2**, Fig. 45, in the feed cam and move the feed cam **Q3**, Fig. 45, toward the arm rock shaft **F3**, Fig. 45.

Remove the feed fork connection **N2**, Fig. 45 and roller **P2**, Fig. 45.

### TO REMOVE AND REPLACE THE FEED REGULATOR

See Fig. 45

To remove the feed regulator, first loosen the clamp stop motion screw **E2**, Fig. 36, page 17, remove the clamp screw **G2**, Fig. 37, page 18, the clamp washer **H2**, Fig. 38, page 18, and remove the balance wheel. On OLD machines, long in disuse, it may be necessary to wash the machine in Varsol, before these parts can be removed.

Remove hinge screw and washer **L2**, Fig. 45. Then remove feed fork connection **N2**, as described on pages 19 and 20.

Remove feed regulator **M2**.

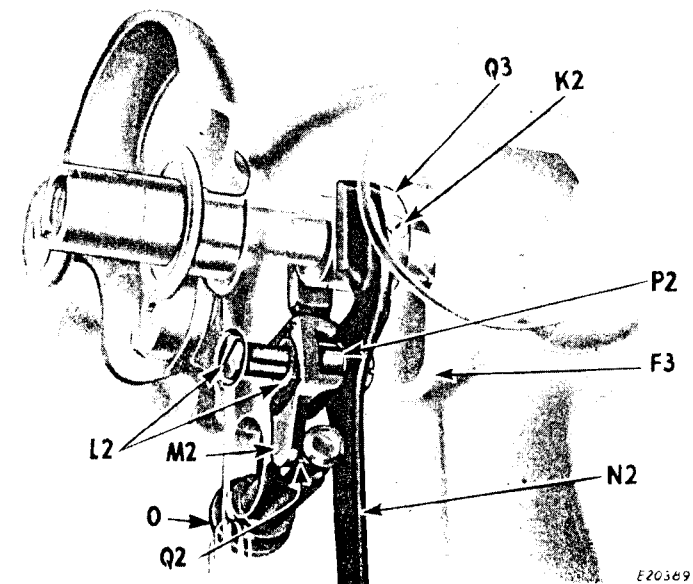

Fig. 45. Showing Relative Positions of Feed Regulator and Feed Fork Connection

To replace the feed regulator **M2**, first set the thumb screw **O**, so that just three screw threads are visible outside the machine arm, as shown in Fig. 44. Slip the feed regulator **M2** into the arm with the stud **Q2** riding in the groove of the thumb screw **O**, as shown in Fig. 45. Replace the hinge screw and washer **L2**.

Replace and secure the feed fork connection **N2**, as described on page 20. Correctly position and secure the feed cam **Q3**, as described on page 20. Adjust the lengthwise position of the feed dog in relation to the throat plate slots, as described on page 17.

Replace and secure the balance wheel, clamp screw and washer, and clamp stop motion screw, as described on page 18.

Turn the balance wheel over toward you by hand, several revolutions, to check for binding of parts just installed and adjusted.

### TO REMOVE THE ARM SHAFT

Before removing the arm shaft, remove the feed fork connection as described on pages 19 and 20.

Then remove screw R2, Fig. 41, and remove the bobbin winder bracket and bobbin winder.

Remove the needle and the needle clamp S2, Fig. 46. Remove the needle stop screw C, Fig. 46, the needle bar thread guide T2, Fig. 46, and the presser foot. Slide the thread cutter U2, Fig. 46, down and off the presser bar. Remove the two face plate screws, the face plate, the presser bar thumb screw V2, Fig. 46, and slide the presser bar spring W2, Fig. 46, and the washer above it, up and off the presser bar. Loosen the presser bar guide bracket screw F, Fig. 46 and lift the presser bar out of the head, disengaging the guide bracket.

Remove the position screw D, Fig. 46, loosen the clamp screw X2, Fig. 46, and lift the needle bar out of the head, disengaging the needle bar cam Y2, Fig. 46, and the cam roller T3, Fig. 46.

Remove the hinge screw at Z2, Fig. 2, page 3 and Fig. 46, and disengage the take-up lever A3, Fig. 46, from the take-up cam H3, Fig. 46.

Remove the eccentric stud cap screw T, Fig. 50, page 26, and carefully slip the shuttle pitman E3, Fig. 50, off the eccentric stud of the arm rock shaft F3, Fig. 50.

Loosen the adjusting screw C3, Fig. 49. Loosen the bushing set screw D3, Fig. 49, at the rear of the arm.

Loosen the stop screw E2, Fig. 36, and remove the clamp screw G2, Fig. 36, by turning it counter-clockwise. Remove the clamp H2, Fig. 38, and the balance wheel. Then remove the taper pin G3, Fig. 43, from the clamp stop motion bushing.

**CAUTION:** To avoid bending the arm shaft, always support the clamp stop motion bushing O3, Fig. 43 on a wooden block, while driving the taper pin G3 in or out.

**Note:** In some of the older machines, where this bushing is held in position by two set screws instead of a tapered pin, these set screws will have to be removed before proceeding.

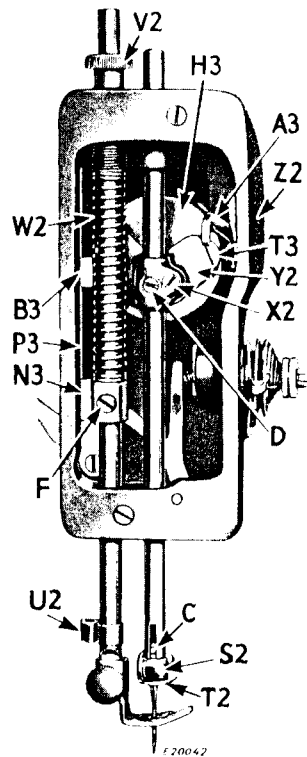

Fig. 46. Removing Needle Bar and Presser Bar

Loosen the set screw K2, Fig. 45, on the feed cam Q3, Fig. 45.

Then, while holding take-up cam H3, Fig. 47, in the position shown in Fig. 47, drive the end of the arm shaft L3, Fig. 44, flush with the balance wheel end of the arm casting. This will release the stop motion flanged bushing O3, Fig. 43. Use a mallet and a drift pin for this operation. (The diameter of the drift pin used should be slightly less than the diameter of the arm shaft.)

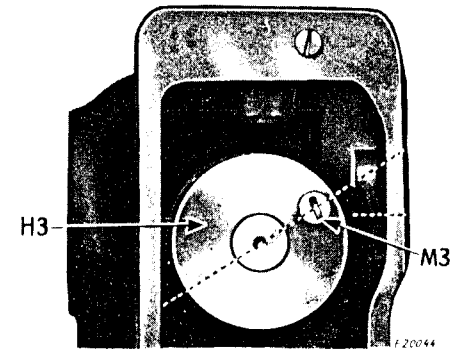

Fig. 47. Showing Proper Position of Take-Up Cam While Removing Arm Shaft



Fig. 48. Curved Drift Pin Serial 192781 Used to Remove Arm Shaft

After removing the stop motion flanged bushing O3, Fig. 43, insert the curved drift pin K3, Fig. 49, also shown in Fig. 48, into the arm and against the arm shaft bushing J3, in the head of the machine, as shown in Fig. 49.

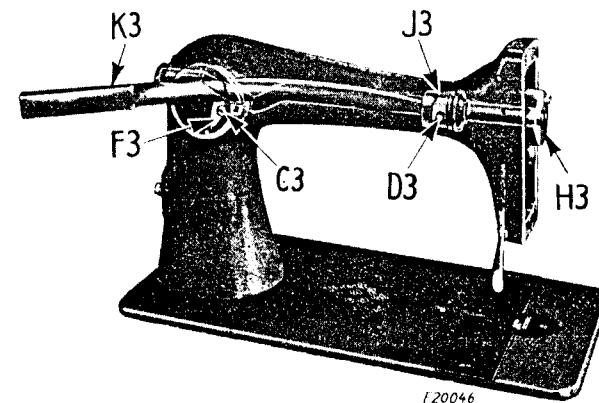

Fig. 49. Removing the Arm Shaft

Then, while still maintaining the position of the take-up cam H3, in relation to the head, as shown in Figs. 47 and 49, drive the arm shaft out of the arm with a mallet and the curved drift pin K3, Fig. 49. The feed cam Q3, Fig. 45, will then fall out of the machine.

### TO INSTALL THE ARM SHAFT

Insert the balance wheel end of the arm shaft into the bushing J3, Fig. 49, in the head of the machine. While holding cam H3, Fig. 47, in the position shown in Fig. 47, pass the arm shaft L3, Fig. 44, between the forks of the arm rock shaft F3, Fig. 49, and slide the feed cam Q3, Fig. 45, on the arm shaft between the arm rock shaft and the balance wheel end of the arm. Place a brass drift pin (1 1/8 inches diameter) against the take-up cam H3, keeping well away from the needle bar roller stud M3, Fig. 47. Then while maintaining the position of the take-up cam H3, shown in Fig. 47, drive the arm shaft L3 through the bushing O3, Fig. 43, in the balance wheel end of the arm, as shown in Figs. 43 and 44.

Place the bushing O3, Fig. 43, on the end of the arm shaft, aligning the taper pin holes in the bushing O3 with the hole in the arm shaft L3. Drive the bushing on the arm shaft until there is neither end play nor binding during the rotation of the arm shaft. Then drive the taper pin G3 into the bushing and the arm shaft, as shown in Fig. 43.

**NOTE:** In some of the older machines, where set screws are used instead of a taper pin, the above alignment of the taper pin is eliminated and the two set screws should be replaced and securely tightened after the arm shaft is properly installed.

Replace the balance wheel on the bushing O3, Fig. 43, on the end of the arm shaft and, after replacing the clamp H2, Fig. 38, with its projections in the slots of the bushing and pointing outward away from the balance wheel, replace and securely tighten the thumb screw G2, Fig. 36. Then tighten the stop screw E2, Fig. 36.

Now securely tighten set screw D3, Fig. 49, in the rear of the arm, and adjust the arm rock shaft, as described on page 25. Then carefully slip the arm rock shaft end of the shuttle pitman E3, Fig. 50, page 26, on the eccentric stud of the arm rock shaft F3, Fig. 50. Replace and tighten eccentric stud cap screw T, Fig. 50.

Replace the thread take-up lever A3, Fig. 46, with its roller sliding in the groove of the cam H3, Fig. 46. Replace and securely tighten the hinge screw at Z2, Fig. 2, page 3 and Fig. 46.

Replace the cam roller on the stud M3, Fig. 47, of the cam H3, Fig. 47. Place the needle bar cam Y2, Fig. 46, over the cam roller T3, Fig. 46, slipping the flat extension B3, Fig. 46, of the needle bar cam into the grooved slide in the head, as shown in Fig. 46. Pass the needle bar through the holes provided for it in the head and in the needle bar cam Y2. Replace the position screw D, Fig. 46, the thread guide T2, Fig. 46, and the needle clamp S2, Fig. 46. Adjust the height of the needle bar, as described on page 9. Securely tighten the set screw D and the clamping screw X2, Fig. 46, and replace the needle.

Slip the flat extension N3, Fig. 46, of the presser bar guide bracket into the slotted slide P3, Fig. 46, as shown in Fig. 46. Pass the presser bar through the holes provided for it in the head of the machine and in the guide bracket. Replace the thread cutter U2, Fig. 46, and the presser foot.

Slip the presser bar spring W2, Fig. 46, and the washer on the presser bar, and then replace the thumb screw V2, Fig. 46. Set the presser bar at the correct height and align the presser foot with the feed dog and the needle, as described on page 10. Securely tighten the guide bracket screw F, Fig. 46.

Replace the face plate and the face plate screws. Replace the bobbin winder, bracket and bracket screw R2, Fig. 41, and securely tighten the screw R2.

Turn the balance wheel over toward you by hand, several revolutions, to check for binding of parts installed. **The machine should then be "run-in" by an electric motor for from 15 to 30 minutes, or until all moving parts run smoothly.**

Install the feed fork connection, as described on page 20.

### TO REMOVE THE ARM ROCK SHAFT

First remove the feed fork connection as described on pages 19 and 20 and then remove the arm shaft, as described on pages 22 and 23.

Remove the eccentric stud cap screw T, Fig. 50, and carefully slip the shuttle pitman E3, Fig. 50, off the eccentric stud of the arm rock shaft F3, Fig. 50.

Loosen the screw center nut R3, Fig. 50, and turn back the center screw S3, Fig. 50, sufficiently to remove the arm rock shaft through the hole in the base of the machine.

### TO REPLACE AND ADJUST THE ARM ROCK SHAFT

Insert the arm rock shaft F3, Fig. 50, through the hole in the base of the machine and into the upright part of the arm, then turn the center screw S3 clockwise just enough to hold the arm rock shaft in place.

Turn the balance wheel over toward you by hand, several revolutions, to check for binding of parts installed. **The machine should then be "run-in" by an electric motor for from 15 to 30 minutes, or until all moving parts run smoothly.**

Install the arm shaft as described on page 24 and above.

After the arm shaft is installed, tighten the adjusting screw C3, Fig. 49, until the arm shaft L3, Fig. 44, rides tightly, without binding, between the forks of the arm rock shaft F3, Fig. 49.

Carefully slip the arm rock shaft end of the shuttle pitman E3, Fig. 50, on the eccentric stud of the arm rock shaft F3, Fig. 50. Replace and securely tighten eccentric stud cap screw T, Fig. 50.

Tighten the center screw S3, Fig. 50, until there is neither end play nor binding during the arm rock shaft movement. Securely tighten the center nut R3, Fig. 50.

Then install the feed fork connection, as described on page 20.

## TO LOCATE AND CORRECT FOR BINDING OF MOVING PARTS

See Fig. 50

When a machine binds, check first to see that there is no dried grease or other foreign matter obstructing the moving parts. Use Varsol to clean these parts, where required.

To locate a mechanical source of binding, disconnect the upper from the lower sewing mechanism, as follows: Remove the eccentric screw **C2**, and nut **D2**, disengaging the feed fork connection **N2**, from the feed rock shaft **O2**. Then remove eccentric stud cap screw **T**, and carefully slip the shuttle pitman **E3**, off the eccentric stud of the arm rock shaft **F3**.

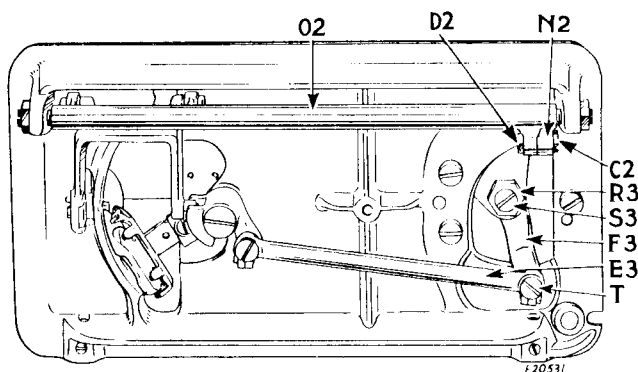

Fig. 50. Locating the Sources of Binding

Check freedom of movement of various parts of shuttle mechanism, by moving shuttle pitman **E3** back and forth several times, along the bed of the machine.

Test feeding mechanism, by turning feed rock shaft **O2** over and back repeatedly, observing action of entire feeding linkage.

Check upper sewing mechanism by raising and lowering take-up lever **A3**, Fig. 46, several times and by turning balance wheel over toward you by hand, several revolutions.

When these tests do not disclose the sources of binding, check to see that the various settings and adjustments of the sewing mechanism have been properly made, according to the instructions on pages 8 to 17.

When binding parts are discovered, remove them and replace with new **SINGER\*** parts.

Slip end of shuttle pitman **E3**, on eccentric stud of arm rock shaft **F3**, and replace and securely tighten cap screw **T**. Engage feed fork connection **N2** with feed rock shaft **O2** and replace and securely tighten eccentric screw **C2** and nut **D2**.

### TO "RUN-IN" THE MACHINE

When a machine is completely assembled and adjusted, it should be checked for binding first. Then it should be "run-in" by an electric motor, for from 15 to 30 minutes, or until all moving parts run smoothly.

"Running-in" a machine should be done after every installation of an arm shaft or an arm rock shaft, and after every general repair.

SINGER Needles should be used  
in SINGER Machines.  
These Needles and their Containers  
are marked with the  
Company's Trade Mark "SIMANCO.\*" 1

Needles in Containers marked  
"FOR SINGER MACHINES"  
are NOT **SINGER** made needles. 2